

Eris XT-Series E5 XT / E7 XT / E8 XT

High-Definition Near Field Studio Monitors

Owner's Manual

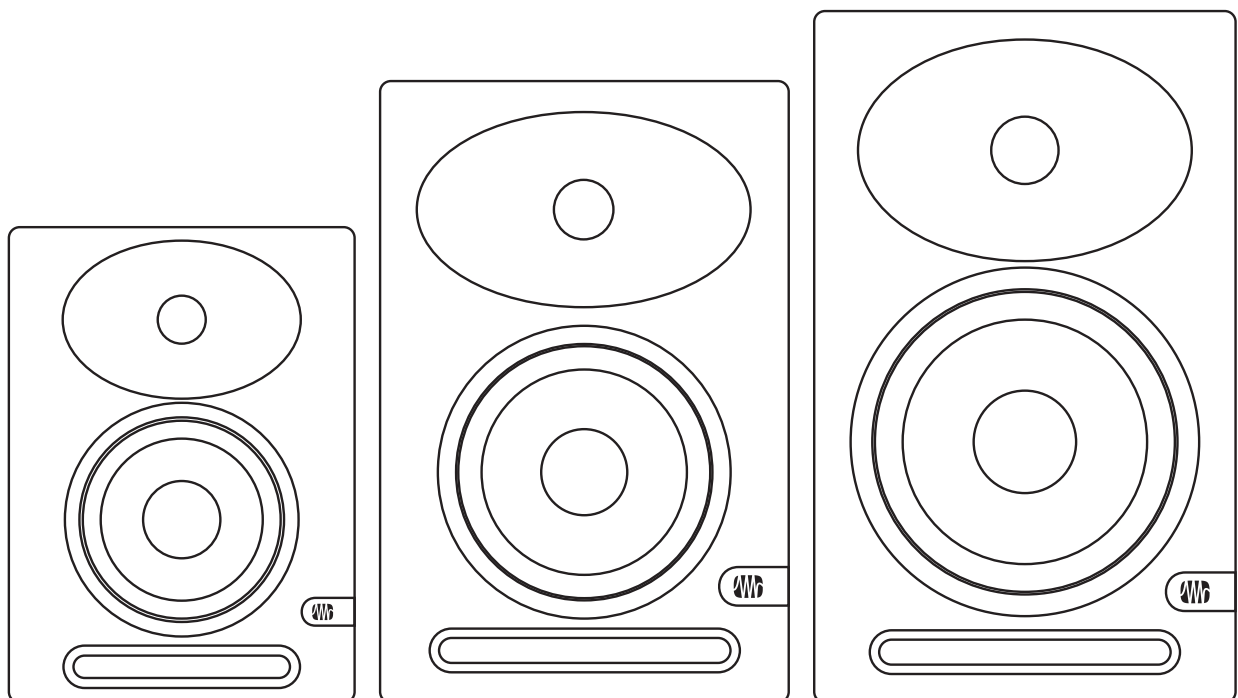

Table of Contents

1 Overview — 1

- 1.1 Introduction — 1
- 1.2 Product Registration — 2
- 1.3 What's in the Box — 2
- 1.4 Companion PreSonus Products — 3

2 Hookup — 4

- 2.1 Rear Panel Connections and Controls — 4
 - 2.1.1 Inputs — 4
 - 2.1.2 Power — 4
 - 2.1.3 Acoustic Tuning Controls — 5
- 2.2 Hookup Diagrams — 6
 - 2.2.1 Basic Setup — 6
 - 2.2.2 Advanced Setup with Monitor Controller and Speaker Switching — 7

3 Application Guide — 8

- 3.1 Monitor Placement and Acoustic Space Settings — 8
- 3.2 Calibrating Using 85 dB SPL "Standard" Reference — 10

4 Resources — 12

- 4.1 Technical Specifications — 12
- 4.2 Troubleshooting — 13

1 Overview

1.1 Introduction

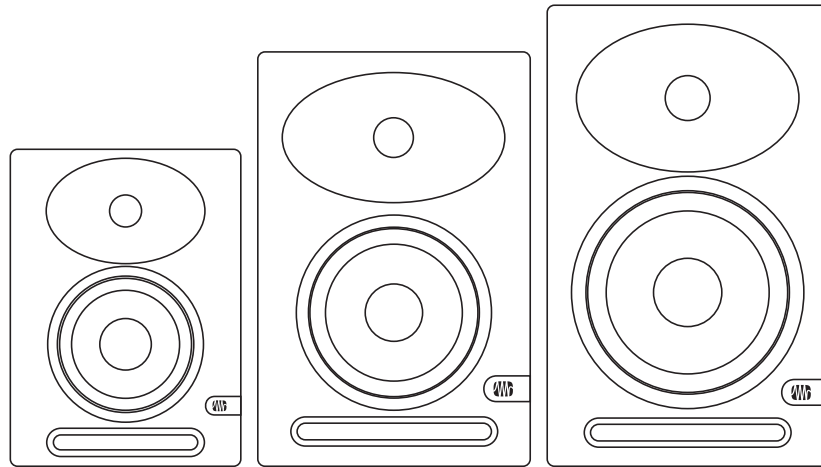

Thank you for purchasing Eris XT-series studio monitors. With their superb high-frequency response; extended low end; powerful amplification with tons of headroom; and acoustic tuning functions to mitigate any problem acoustics in your mix environment, Eris XT-series studio monitors ensure your mix translates from the studio to the stereo.

PreSonus Audio Electronics is committed to constant product improvement, and we highly value your suggestions. We believe the best way to achieve our goal of constant product improvement is by listening to the real experts; our valued customers. We appreciate the support you have shown us through the purchase of this product and are confident that you will enjoy your Eris XT-series studio monitors.



About this manual: We suggest that you use this manual to familiarize yourself with the features, applications, and workflows for your Eris XT-series studio monitors before trying to connect it to the rest of your studio equipment. This will help you to get better performance and results.

Throughout this manual you will find **Power User Tips** that can quickly make you an Eris expert so you can get the most out of your investment. If this is your first pair of studio monitors, please take a look at Section 3 for details on setting them up properly in your mix environment. More information is available at www.presonus.com/learn/technical-articles.

1.2 Product Registration

PreSonus is committed to delivering the best experience for our customers. My PreSonus is a one-stop portal for all our registered customers' needs. From your my PreSonus account, you can view all your PreSonus hardware and software registrations; contact support; track orders and more.

Don't have a My.PreSonus account yet? Here's why you should sign up.

-  One account gets you everything you need, from support to forums to product info and upgrades. Get the inside track on training videos, tutorials, special offers, and advance notifications.
-  Register a product on My.PreSonus and you're eligible for technical support, timely updates, expedited warranty service and quick tracking should you ever need repair. You also get special promotions that are 'members only'!
-  Join the ever-growing community of PreSonus users and share ideas, projects, and yes, gripes on our forum and blogs. It's a lively, Cajun-tinged vibe and it's waiting for you.

[Create My.PreSonus Account](#)

To register your Eris XT studio monitor, go to My.PreSonus.com and follow the onscreen instructions.

OR



Download the MyPreSonus app from the Apple App Store or Google Play.

1.3 What's in the Box

Your Eris XT package contains the following:

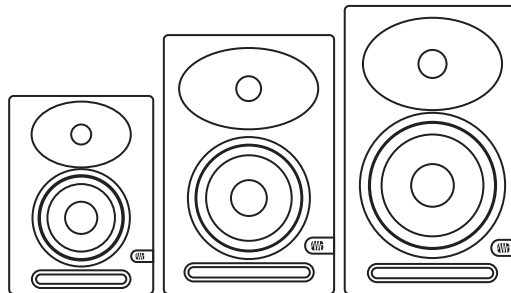

Eris E5 XT, Eris E7 XT, or Eris E8 XT studio monitor

Eris XT Quick Start Guide

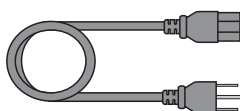
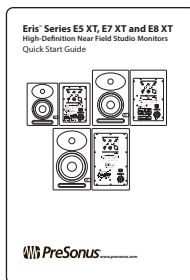

IEC Power Cable

1.4 Companion PreSonus Products

Thanks for choosing PreSonus! As a solutions company, we believe the best way to take care of our customers (that's you) is to ensure that you have the best possible experience from the beginning of your signal chain to the end. To achieve this goal, we've prioritized seamless integration throughout every design phase of these products from day one. The result is systems that communicate with each other as intended – straight out of the box – without excessive configuration hassles.

We're here for you. Find out more at www.presonus.com



2 Hookup

2.1 Rear Panel Connections and Controls

2.1.1 Inputs

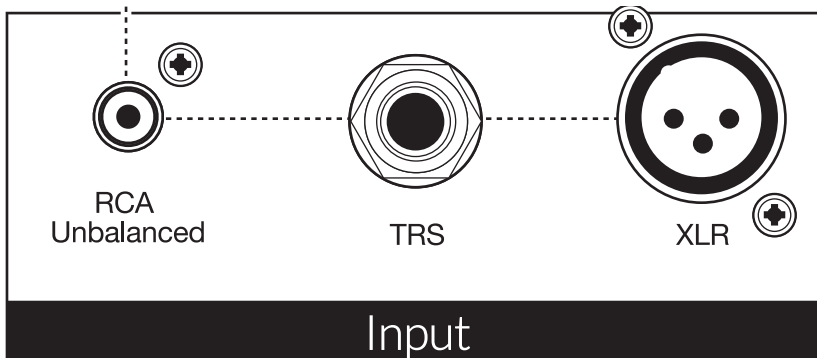

Line-level Inputs. The Eris XT studio monitors provide a choice of three line-level input types: balanced XLR, balanced ¼" TRS, and unbalanced RCA. Do not connect more than one source to your Eris XT studio monitors simultaneously.

Power User Tip: Whenever possible, it is recommended that you utilized the balanced line-level inputs on your Eris XT studio monitors. Balanced cables and connections are resistant to induced noise from radio frequencies and electromagnetic interference (RFI and EMI). If your audio source has only unbalanced connections (either ¼" TS or RCA), it is recommended that the RCA input be used. ¼" TS-to-RCA cables and adapters are readily available at most music supply stores. Whether utilizing the balanced or unbalanced inputs, always use the shortest cable length possible to minimize the risk of induced noise in your studio monitors.

Input Gain. Sets the level of the input signal before it is amplified.



2.1.2 Power

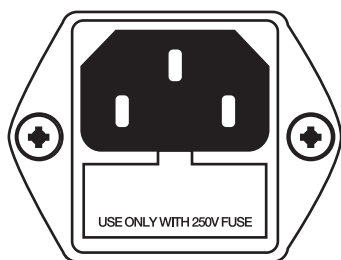

100-120V~, 50-60Hz, T2AL
220-240V~, 50-60HZ, T1 AL
160W

IEC Power Connection. This is the power inlet for your Eris XT studio monitor.

Warning: Do not remove the center grounding prong or use a ground-lift adapter, as this could result in electric shock.

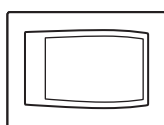

Power

Power Switch. This is the On/Off switch for your Eris XT studio monitor. When your Eris XT studio monitor is powered On, the blue LED on the front panel will illuminate.



AC Select

AC Select Switch. The input-power voltage is set at the factory to correspond with the country to which the Eris XT studio monitor was shipped. Use this switch only if you are using your Eris monitor in a country that uses a different standard voltage than is used in the country where you purchased your monitor originally.

2.1.3 Acoustic Tuning Controls

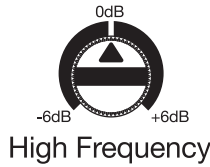

High Frequency

High Frequency. Boosts or cuts all frequencies above 10 kHz by ± 6 dB.

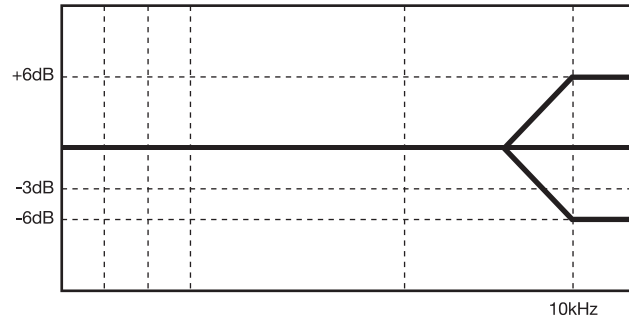

Power User Tip: The High control on the Eris XT studio monitors is a high-shelf EQ and raises or lowers all frequencies above 10 kHz. This EQ is much like the treble control on a car stereo and likewise can make big changes to the sound very quickly. If you find your mixes are translating too dark on other speaker systems, try lowering this control. Too bright? Raise this control a bit. In either case, anomalies in your room may be negatively impacting your Eris XT studio monitors' performance. See Section 3 for set-up and calibration tips.

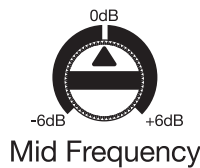

Mid Frequency

Mid Frequency. Boosts or cuts frequencies around 1 kHz by ± 6 dB.

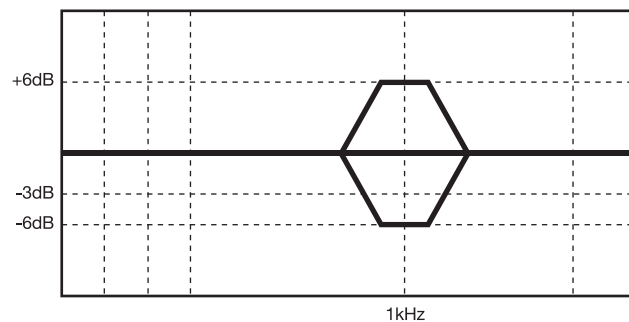

Power User Tip: The Mid control is a peak EQ that lets you raise or lower the level of a two-octave-wide frequency band centered at 1 kHz that can make subtle changes to the frequency response of your Eris XT monitors. In general, you will not want to alter this control as it will change the flat frequency response of your Eris XT monitors. However, if you would like to quickly emulate the performance of consumer speakers, lowering this control will mimic the mid-range scoop that is the hallmark of consumer designs.

Low Cutoff



Low Cutoff. Rolls off the level of all frequencies below the specified frequency (80 or 100 Hz) at a slope of -12 dB / octave. Setting this control to Flat allows the Eris XT's national roll off to take over.

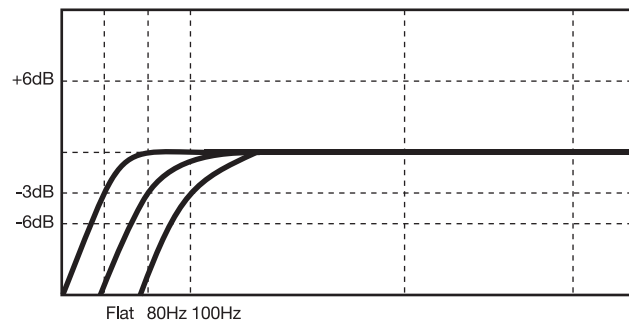

Power User Tip: If you are using a subwoofer that doesn't feature a variable low pass filter, like the PreSonus Temblor T10 provides, you will use this control to set the crossover point for your 2.1 system. For information on configuring a 2.1 system in the studio, please visit www.PreSonus.com/Learn/Technical-Articles.

Acoustic Space



- 0dB — Middle of room
- 2dB — Close to wall
- 4dB — Corner placement

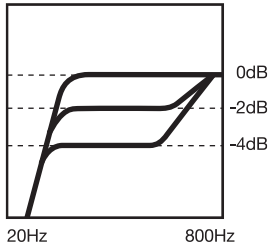

Acoustic Space. Cuts the level of all frequencies below 800 Hz by either -4 dB or -2 dB to compensate for the bass boost that naturally occurs when a speaker is placed near a wall or a corner. If your Eris XT monitors can be placed away from the walls in your mix space, leave this control set to 0 dB.

Power User Tip: The closer your studio monitors are to a wall or a corner, the more the boundary bass will be boosted. If you notice your mixes lack low end when played away from your mix environment, try adjusting the Acoustic Space to create a more even frequency response and help to mitigate a compact mix position. For more information on studio monitor placement, please review Section 3.1.

Acoustic Space

2.2 Hookup Diagrams

2.2.1 Basic Setup

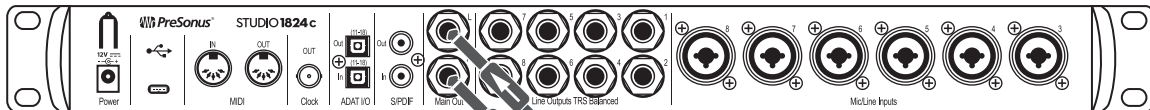

Audio Interface (Studio 1824c)

Eris E8 XT

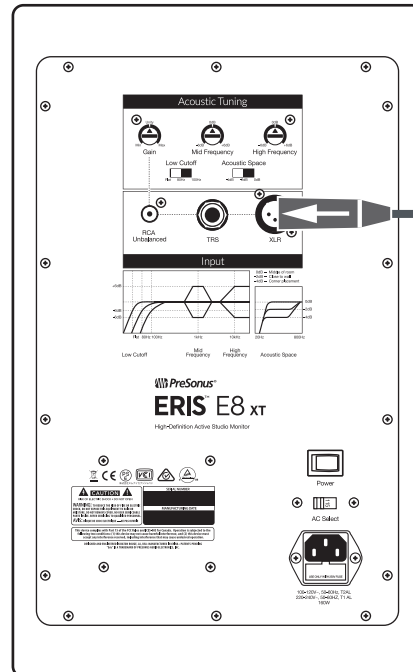
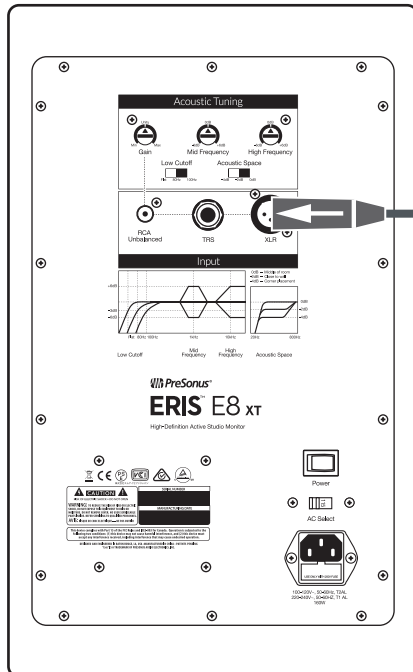

2.2.2 Advanced Setup with Monitor Controller and Speaker Switching

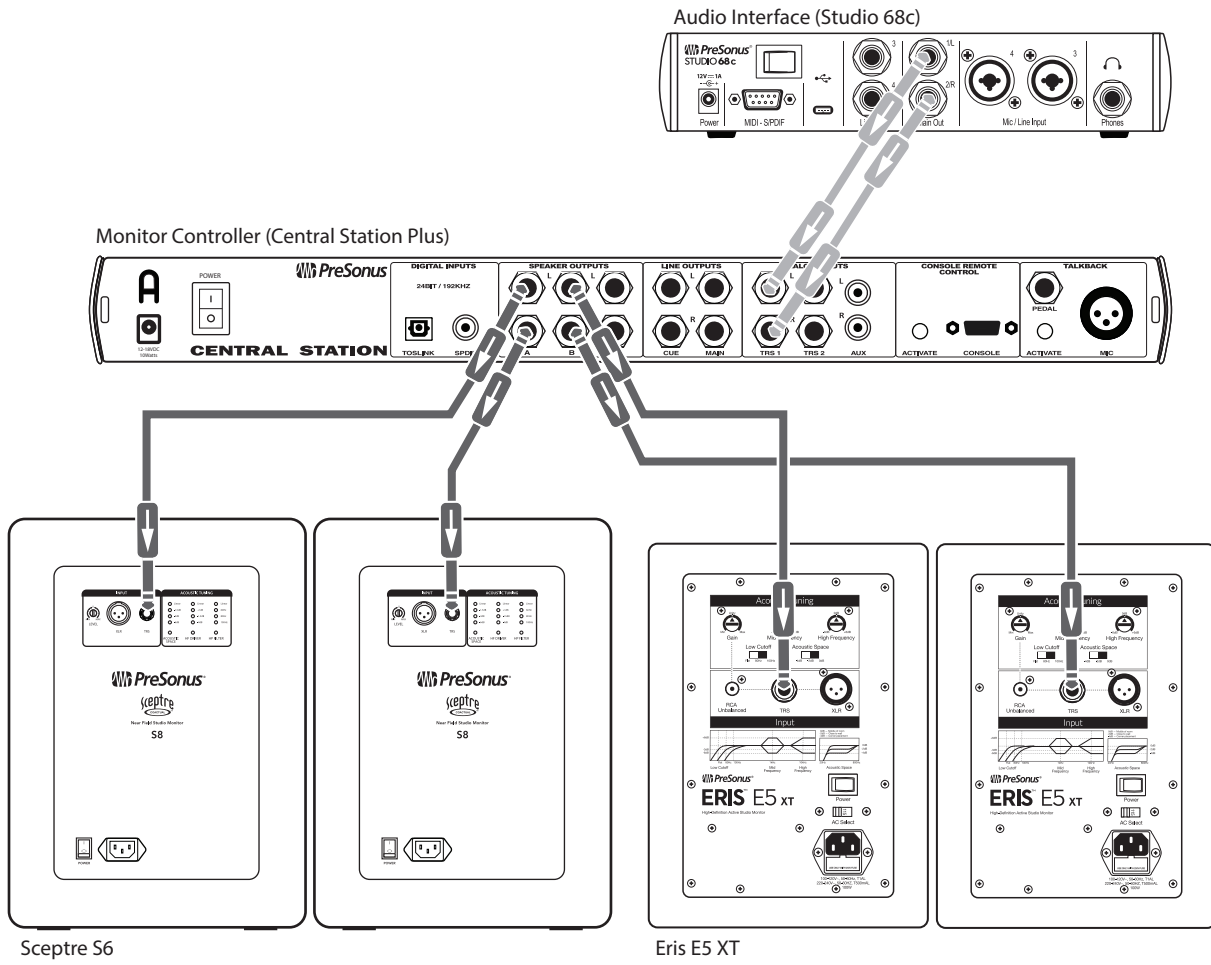

3 Application Guide

3.1 Monitor Placement and Acoustic Space Settings

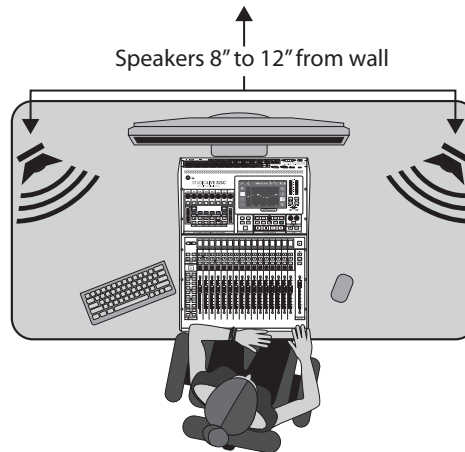

Before placing your studio monitors in your mixing environment, position your desk or monitor stands so that your speakers will be at least 8 to 12 inches away from walls and corners. This will be adequate to prevent sound waves from hitting the wall and reflecting back to you, causing phase cancellation and other potentially harmful acoustic interactions. This might not always be possible, and there are some ways to mitigate cramped mixing spaces.

When a monitor is placed close to a wall, or in a corner, the low frequencies tend to be emphasized more than if the monitor is some distance away from any room boundary. Commonly referred to as “boundary bass boost,” it is most pronounced if the monitor is in a corner and less pronounced, but still present, if the monitor is near one wall. While an increased bass response may be desirable in a listening environment, for studio mixing this can cause mixing to sound too bright when played on consumer stereo systems because the audio engineer will instinctively reduce the bass content in the mix to counterbalance for what they are hearing in the studio.

To compensate for this phenomenon, every PreSonus studio monitor is equipped with an Acoustic Space control that cuts all frequencies below 800 Hz by a specified amount:

- If your Eris XT studio monitors are close to the corners of the room, start by setting the Acoustic Space switch to -4 dB. This will provide the most bass attenuation.
- When Eris XT studio monitors are placed closer to the back wall, set the Acoustic space switch to -2 dB.
- If your mix environment affords enough space for your studio monitors to be placed away from the room's boundaries, leave the Acoustic Space switch at 0 dB as no bass attenuation should be necessary.

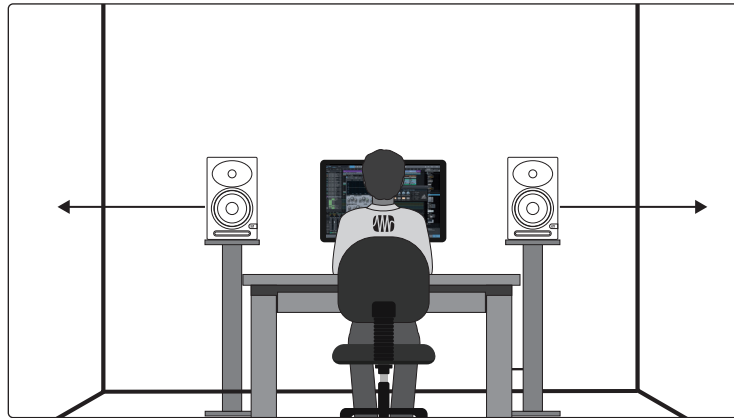

If possible, your mix position should be placed on the center of a wall as this will provide a more balanced listening position. Place your speakers so that they are the same distance from the sides of the room. That is, if your left speaker is six feet from the wall to the left and two feet from the wall behind, your right speaker should be six feet from the wall to the right and two feet from the wall behind. By centering your mix position, your monitor system will provide more reliable low-frequency intelligibility. In a rectangular room, it is best to set up along one of the long walls, especially in a smaller room. This will minimize problems caused by side wall reflections.

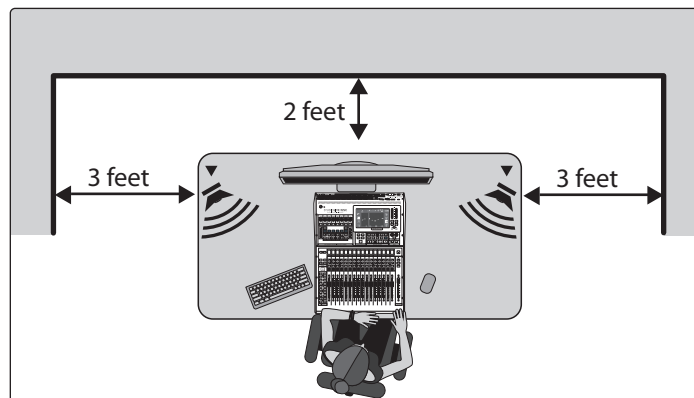

Just like it's not a good idea to set up your mix position in a corner, it's not a good idea to create a corner with your mix position. Make sure the distance from the speaker to the wall behind it is different than the distance from the side wall closest to it. For example, if your left speaker is one foot from the wall to its left, it shouldn't also be one foot from the wall behind it.

The Eris XT's focused EBM waveguide design ensures wider horizontal coverage with a tight vertical dispersion that helps to limit early reflections from your desk or console. Unlike other Eris monitors that can be placed horizontally or vertically, this design requires that the Eris XT monitors always be placed in their vertical orientation.

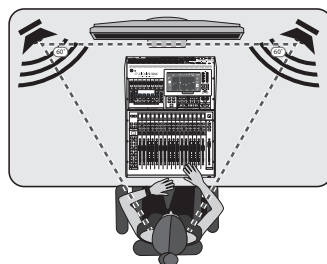

Whenever people talk about listening to speaker systems, they talk about the "sweet spot." As mentioned earlier, this is the middle position between the two sides of a stereo system, where the speakers overlap, and it is where the stereo image will be the best.

Creating the sweet spot is relatively easy. Simply angle, or “toe-in,” each speaker so that the tweeters form an equilateral triangle with your head—that is, the speakers are the same distance from each other as they are from you. The monitors should be angled, or “toed in,” so that they are each directed to an ear, rather than pointed straight ahead.

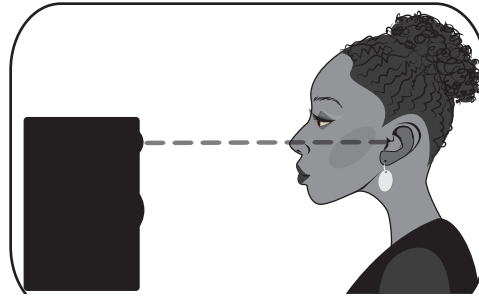

Ideally, near-field studio monitors like the Eris XT-series should be placed so that the high-frequency drivers (commonly known as ‘tweeters’) are at the same height as your ears when you are seated in the mix position.

High-frequency content is much more directional than low frequency content. Because of this, you can more accurately hear what is happening if the high frequencies are directed at your ear. Once you have created the sweet spot, sit down and make sure that your ears are level with the center of tweeter.

3.2 Calibrating Using 85 dB SPL “Standard” Reference

After you have properly positioned your studio monitors and listening position, it is helpful to set all the levels in your studio so that you are optimizing every component. Taking the time to properly calibrate your speakers can be very valuable in this respect and will also give you a great starting point to troubleshoot or fine-tune your mixing environment.

The main purpose of speaker calibration is to ensure that a specific metered audio level in your DAW or on your mixer equals a predetermined SPL in your studio environment. Depending upon the method and reference levels used during calibration, proper calibration can help reduce unwanted noise, minimize the risk of damage to your studio monitors and to your ears, maximize the reference capabilities of different speaker types, and ensure you hear the audio as accurately as possible.

When calibrating reference monitors in a studio, the acoustic level or sound pressure level (SPL) should be measured from the mix position at seated ear height. There are an assortment of great SPL metering apps on the market for smartphones, and many are free! You can also find accurate SPL meters at your favorite local electronics-supply store.

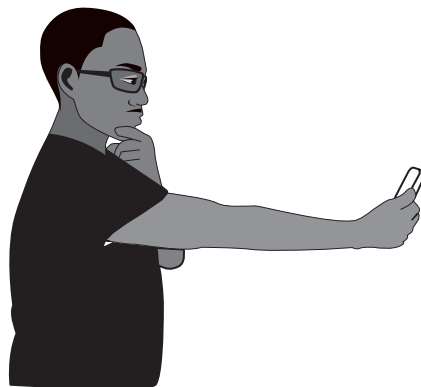

The SPL meter should be held at arm’s length, with the microphone pointed at the center point between the left and right speakers (where your head will be), angled at 45 degrees to ensure an accurate reading. If your SPL meter is also your cell phone, make sure your finger or cell phone case isn’t covering the mic!

You should calibrate the right and left monitors independently to ensure that both monitors are set to the same acoustic level. This will ensure that your stereo mixes are balanced and will translate well across different speaker systems.

The goal of this Standard Reference Calibration is to ensure that when the output meters in your DAW or mixer register 0 dB, the SPL at your mix position is 85 dB.

1. Connect the main outputs of your audio source to your studio monitors. The left output should be connected to the speaker on your left. The right output should be connected to the speaker on your right.
2. Begin by turning the input sensitivity of your Eris XT monitors to the lowest setting.

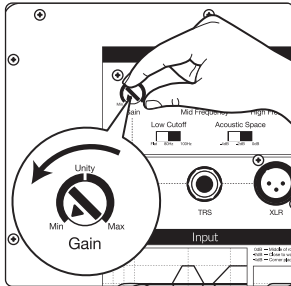

3. Turn the output of your audio source (audio interface, mixer, or speaker-management device) to its lowest setting.

Note: If you have any outboard processors (EQs, limiter, etc.) connected between the audio source and your monitors, disconnect or bypass them. If your audio source is a mixer, make sure that it is zeroed out.

Play 20 Hz to 20 kHz full-bandwidth pink noise at 0 dB through the outputs of your primary audio source.

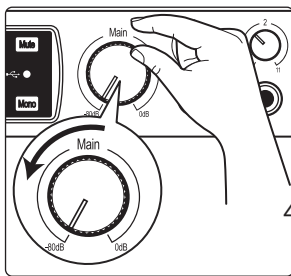

5. Turn up the outputs of your primary audio source to the unity gain setting. “Unity gain” is the setting at which the signal level is neither boosted nor attenuated. It is usually marked by a “0” or a “U” on the audio device’s level fader or knob. In many digital interfaces and digital devices, the device’s maximum level is also its unity gain setting. Please consult your audio device’s user’s manual or the manufacturer’s Web site for more information on its levels and adjustments. You should not hear the pink noise. If you do, repeat step 2.

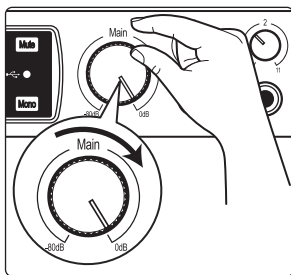

6. While measuring the output level with an SPL meter, begin slowly increasing the input sensitivity (volume) of your left speaker until the acoustic level of the test tone playing reaches 82 dB SPL. When both speakers play simultaneously, the overall SPL will increase by about +3 dB (85 dB).

Power down your left speaker.

Slowly increase the input sensitivity (volume) of your right speaker until the acoustic level of the test tone playing reaches 82 dB SPL.

Stop the pink noise and turn your left speaker back on. Play some program music you are familiar with through your speakers and sit down in your mix position. You may need to fine-tune your speaker placement until the sound is balanced and you have a nice, wide sweet spot from which to mix.

Note: If 85 dB is too loud for your room, either because of noise constraints or because the room is too small, you can redo the above calibration steps and dial in each speaker to 79 dB instead. The important thing is that both speakers are set to the same SPL level, not the level itself.

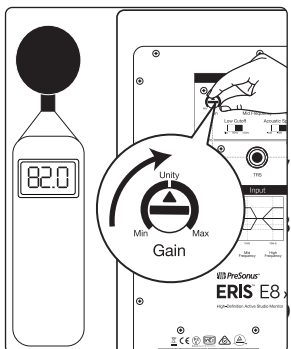

4 Resources

4.1 Technical Specifications

Inputs

1- Balanced XLR
1- Balanced ¼"TRS
1- Unbalanced RCA

Performance	E5XT	E7XT	E8XT
Frequency Response	48 Hz to 20 kHz	42 Hz to 22 kHz	35 Hz to 20 kHz
Crossover Frequency	3 kHz	2.5 kHz	2.2 kHz
LF Amplifier Power	45W	70W	75W
HF Amplifier Power	35W	60W	65W
Peak SPL (@ 1 meter)	102 dB	104 dB	105 dB
LF Driver	5.25"	6.5"	8"
HF Driver	1" Silk Dome	1.25" silk dome	1.25" silk dome

User Controls

Volume Range	A-Type Taper
MF Control	-6 to +6 dB
HF Control	-6 to +6 dB
Low Cut	Flat, 80 Hz, 100 Hz
Acoustic Space	Flat, -2 dB, -4 dB
Protection	RF interference Output-current limiting Over-temperature Turn-on/off transient Subsonic filter External mains fuse
Power	100-120V ~50/60 Hz or 220-240V ~50/60 Hz
Cabinet	Vinyl-laminated, medium-density fiberboard

Physical

Width	8" (203 mm)	9.45" (240mm)	9.75" (248 mm)
Depth	9" (229 mm)	9.5" (242 mm)	11.5" (292 mm)
Height	11" (279 mm)	14.4" (365 mm)	16" (406 mm)
Weight	11 lbs (5 kg)	18.5 (8.37 kg)	23 lbs (10.4 kg)

4.2 Troubleshooting

No Power. First ensure that your Eris XT studio monitor is plugged in. If it's connected to a power conditioner, verify that the power conditioner is turned on and functioning. If problem still exists, disconnect the power cable from your studio monitor and check the fuse on the back panel.

The fuse housing is located directly beneath the IEC power cable connection. A blown fuse may look black on the inside or the wire inside might appear broken. A very black fuse is a sign that something may have shorted out. Try replacing the fuse with a new one. The E5XT uses a T1L fuse. The Eris E7XT and E8XT use a T2L fuse. If the fuse blows again, you will need to contact PreSonus for a repair.

No audio. If your Eris XT studio monitor appears to power on but you hear no sound when playing audio from your audio source (the lights are on but nobody's home), first make sure that the cable connecting your audio source to the monitor is working correctly. Also, verify that the Input Gain control is set to provide enough amplitude for the signal.

Hum. Usually, hum is caused by a ground loop. Verify that all audio equipment is connected to the same power source. If you are not using a power conditioner, we highly recommend that you add one. Not only will this help to minimize hum, it will better protect your equipment from power surges, brownouts, etc. Use balanced cables whenever possible. If your audio device does not offer a balanced output, you can connect it to a direct box, which will provide a ground-lift switch and a balanced output. Finally, make sure that your audio cables are not run near power cables, and use cables that are the appropriate length for your application. Using cables that are too long not only increases the risk of noise, it increases the likelihood that the cables are coiled, which will essentially create an antenna that picks up all kinds of audio interference.

Added bonus: PreSonus' previously Top Secret recipe for...

Red Beans and Rice

Ingredients:

- 1 lb dried Red Kidney Beans
- 1 large onion (diced)
- 3 celery stalks (diced)
- 1 large green bell pepper (diced)
- 6-8 C vegetable stock
- 1 Tbs. Old Bay seasoning
- ½ fresh parsley
- 2 tsp. kosher salt
- 2 Tbs. olive oil
- 1 smoked ham hock (optional)

Cooking instructions:

1. Rinse red beans in cold water.
2. In a pressure cooker, heat olive oil on medium high. Sauté onion, celery, bell pepper, beans, and ham hock (if using) until onions are translucent.
3. Stir in Old Bay, parsley, and salt.
4. Add vegetable stock until beans and vegetables are covered.
5. Close pressure cooker and bring to full pressure on high heat.
6. Reduce heat to low while maintaining full pressure. Cook for 40 minutes.
7. Allow pressure to drop naturally (20-30 minutes).
8. Remove lid and crush with a potato masher until creamy.
9. Correct seasoning with salt and pepper if necessary.
10. Serve over rice with hot sauce and grilled Andouille sausage (optional).

Eris XT-Series E5 XT / E7 XT / E8 XT

High-Definition Near Field Studio Monitors

Owner's Manual

