

# Digitakt

Beat making powerhouse

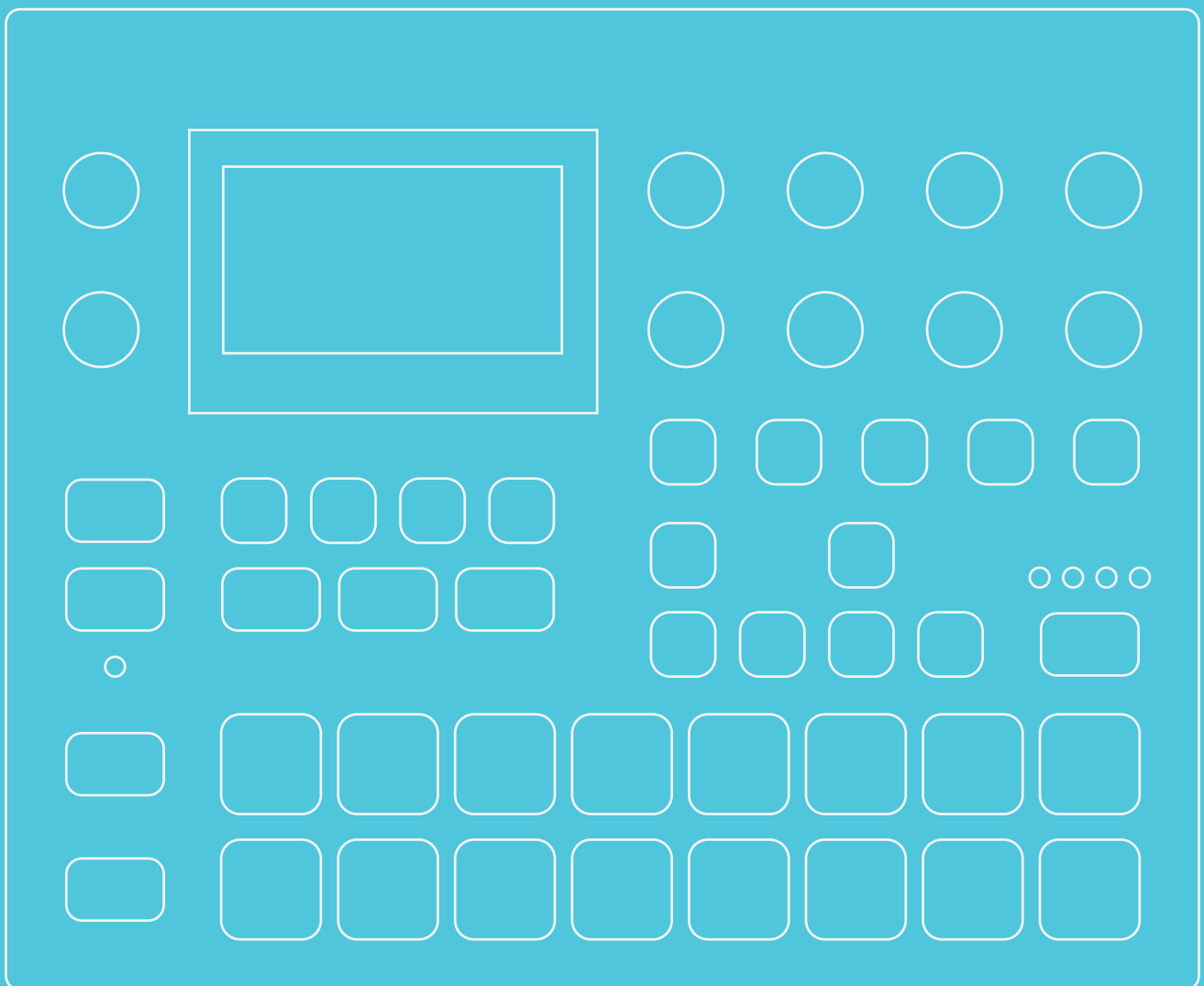

**User Manual**

### **FCC compliance statement**

This device complies with part 15 of the FCC rules. Operation is subject to the following two conditions: (1) This device may not cause harmful interference, and (2) this device must accept any interference received, including interference that may cause undesired operation.

NOTE: This equipment has been tested and found to comply with the limits for a Class B digital device, pursuant to Part 15 of the FCC Rules. These limits are designed to provide reasonable protection against harmful interference in a residential installation. This equipment generates, uses and can radiate radio frequency energy and, if not installed and used in accordance with the instructions, may cause harmful interference to radio communications. However, there is no guarantee that interference will not occur in a particular installation. If this equipment does cause harmful interference to radio or television reception, which can be determined by turning the equipment off and on, the user is encouraged to try to correct the interference by one or more of the following measures:

- Reorient or relocate the receiving antenna.
- Increase the separation between the equipment and receiver.
- Connect the equipment into an outlet on a circuit different from that to which the receiver is connected.
- Consult the dealer or an experienced radio/TV technician for help.

### **Canada**

This Class B digital apparatus complies with Canadian ICES-003.  
Cet appareil numérique de la classe B est conforme à la norme NMB-003.

### **European Union regulation compliance statement**

This product has been tested to comply with the Low Voltage Directive 2006/95/EC and the Electromagnetic Compatibility Directive 2004/108/EC. The product meets the requirements of RoHS 2 Directive 2011/65/EU.



This symbol indicates that your product must be disposed of properly according to local laws and regulations.

### **Legal disclaimer**

The information in this document is subject to change without notice and should not be construed as a commitment by Elektron. Elektron assumes no responsibility for any errors that may appear in this document. Elektron may also make improvements and/or changes in the products and programs described in this document at any time without notice. In no event shall Elektron be liable for any special, indirect, or consequential damages or any damages whatsoever resulting from loss of use, data, or profits, whether in an action of contract, negligence, or other action, arising out of or in connection with the use or performance of this information.

## IMPORTANT SAFETY AND MAINTENANCE INSTRUCTIONS

Please read these instructions carefully and adhere to the operating advice.

1. Do not use this unit near water.
2. Never use aggressive cleaners on the casing or on the screen. Remove dust, dirt and fingerprints with a soft, dry and non-abrasive cloth. More persistent dirt can be removed with a slightly damp cloth using only water. Disconnect all cables while doing this. Only reconnect them when the product is safely dry.
3. Install in accordance with the manufacturer's instructions. Make sure you place the unit on a stable surface before use. If you mount the unit in a rack, be sure to tighten all four screws in the rack mount holes.
4. Connect the unit to an easily accessible electrical outlet close to the unit.
5. When transporting the unit, use accessories recommended by the manufacturer or the original box and padding.
6. Do not install near any heat sources such as radiators, heat registers, stoves, or any other equipment (including amplifiers) producing heat.
7. Do not put the PL-2S Protective Cover (Elektron accessory) on the unit while the unit is powered on.
8. This product, by itself or in combination with amplifiers, headphones or speakers, is capable of producing sound levels that may cause permanent hearing loss. Do not operate at a high volume level or at a level that is uncomfortable.
9. Protect the power cord from being walked on or pinched particularly at plugs, convenience receptacles, and the point where they exit from the unit.
10. Only use attachments/accessories specified by the manufacturer.
11. Unplug this unit during lightning storms or when it is not used for long periods of time.
12. Refer all servicing to qualified service technicians. Servicing is required when the unit has been damaged in any way, liquid has been spilled or objects have fallen into the unit, the unit has been exposed to rain or moisture, does not operate normally, or has been dropped.

### WARNING

To reduce the risk of fire, electrical shock or product damage:

- Do not expose the unit to rain, moisture, dripping or splashing and also avoid placing objects filled with liquid, such as vases, on the unit.
- Do not expose the unit to direct sunlight, nor use it in ambient temperatures exceeding 40°C as this can lead to malfunction.
- Do not open the casing. There are no user repairable or adjustable parts inside. Leave service and repairs to trained service technicians only.
- Do not exceed the limitations specified in the Electrical specifications.

### SOUND PEAKS

- A brief signal will be sent to all audio outputs of the Digitakt when the Test mode on the STARTUP Menu is activated. Remember to turn down the volume on all speakers and headphones before activating Test mode.
- During calibration there will be loud and unpleasant sounds on all audio outputs. Disconnect these during calibration.

### SAFETY INSTRUCTIONS FOR THE POWER ADAPTER ELEKTRON PSU-3b

- The adapter is not safety grounded and may only be used indoors.
- To ensure good ventilation for the adapter, do not place it in tight spaces. To prevent risk of electric shock and fire because of overheating, ensure that curtains and other objects do not prevent adapter ventilation.
- Do not expose the power adapter to direct sunlight, nor use it in ambient temperatures exceeding 40°C.
- Connect the adapter to an easily accessible electrical outlet close to the unit.
- The adapter is in standby mode when the power cord is connected. The primary circuit is always active when the cord is connected to the power outlet. Pull out the cord to completely disconnect the adapter.
- In the EU, only use CE approved power cords.

### RESTART

- For a complete restart of the Digitakt, wait for at least 30 seconds after turning it off before turning it on again.

---

**TABLE OF CONTENTS**

---

|   |           |
|---|-----------|
| <b>1. INTRODUCTION</b> .....                            | <b>8</b>  |
| 1.1 CONVENTIONS IN THIS MANUAL.....                     | 8         |
| <b>2. THE DIGITAKT</b> .....                            | <b>9</b>  |
| <b>3. PANEL LAYOUT AND CONNECTORS</b> .....             | <b>10</b> |
| 3.1 FRONT PANEL .....                                   | 10        |
| 3.2 REAR CONNECTORS.....                                | 12        |
| 3.3 SETTING UP AND STARTING THE DIGITAKT .....          | 12        |
| <b>4. DIGITAKT SOUND ARCHITECTURE</b> .....             | <b>13</b> |
| 4.1 AUDIO VOICES .....                                  | 13        |
| 4.2 EFFECTS .....                                       | 13        |
| <b>5. OVERVIEW OF THE DIGITAKT DATA STRUCTURE</b> ..... | <b>14</b> |
| 5.1 +DRIVE .....  | 14        |
| 5.2 DATA STRUCTURE .....                                | 14        |
| 5.2.1 PROJECT .....                                     | 14        |
| 5.2.2 PATTERNS .....                                    | 14        |
| 5.2.3 SOUNDS .....                                      | 14        |
| 5.2.4 SAMPLES .....                                     | 14        |
| 5.3 ABOUT THE TRACKS .....                              | 15        |
| 5.3.1 THE AUDIO TRACKS .....                            | 15        |
| 5.3.2 THE MIDI TRACKS.....                              | 15        |
| 5.3.3 EDITING THE TRACKS.....                           | 15        |
| <b>6. THE USER INTERFACE</b> .....                      | <b>16</b> |
| 6.1 SCREEN NAVIGATION .....                             | 16        |
| 6.2 PARAMETER EDITING .....                             | 16        |
| 6.2.1 PARAMETER VALUE JUMP .....                        | 16        |
| 6.2.2 CONTROL ALL .....                                 | 16        |
| 6.2.3 [FUNC] KEY PRESS COMBINATIONS .....               | 17        |
| 6.3 QUICK SCROLLING .....                               | 17        |
| 6.4 COPY, CLEAR, AND PASTE.....                         | 17        |
| 6.5 THE NAMING SCREEN .....                             | 17        |
| 6.5.1 POP-UP NAMING.....                                | 17        |
| 6.6 OVERBRIDGE.....                                     | 18        |
| <b>7. QUICK START</b> .....                             | <b>19</b> |
| 7.1 PLAYING THE FACTORY PRESETS .....                   | 19        |
| 7.1.1 USING CHROMATIC MODE.....                         | 19        |
| 7.1.2 USING MUTE MODE.....                              | 19        |
| 7.1.3 TEMPO .....                                       | 19        |
| 7.1.4 EDITING PARAMETERS.....                           | 20        |
| 7.2 SAMPLING FROM THE EXTERNAL INPUTS.....              | 20        |
| <b>8. DIGITAKT CONTROLS</b> .....                       | <b>21</b> |
| 8.1 TRIG KEYS.....                                      | 21        |
| 8.2 ROTARY ENCODERS.....                                | 21        |
| 8.3 KEY BEHAVIOR.....                                   | 21        |
| 8.4 MIDI NOTES .....                                    | 21        |
| 8.5 MODES.....  | 21        |
| 8.5.1 CHROMATIC MODE.....                               | 21        |

---

|  |           |
|--|-----------|
| 8.5.2 MUTE MODE .....  | 22        |
| <b>9. PATTERNS, KITS, SOUNDS, AND SAMPLES .....</b>          | <b>23</b> |
| <b>9.1 THE +DRIVE SOUND LIBRARY AND THE SOUND POOL .....</b> | <b>23</b> |
| 9.1.1 ADDING SOUNDS TO THE SOUND POOL.....                   | 23        |
| <b>9.2 SOUND BROWSER .....</b>                               | <b>24</b> |
| <b>9.3 SOUND MANAGER .....</b>                               | <b>24</b> |
| <b>9.4 PLAYING A SOUND .....</b>                             | <b>26</b> |
| <b>9.5 EDITING A SOUND .....</b>                             | <b>26</b> |
| <b>9.6 ASSIGNING A SAMPLE.....</b>                           | <b>26</b> |
| 9.6.1 ASSIGNING A SAMPLE USING THE QUICK ASSIGN METHOD ..... | 27        |
| <b>10. THE SEQUENCER .....</b>                               | <b>28</b> |
| <b>10.1 BASIC PATTERN OPERATIONS .....</b>                   | <b>28</b> |
| 10.1.1 SELECTING BANK AND PATTERN.....                       | 28        |
| 10.1.2 PATTERN CONTROL .....                                 | 28        |
| 10.1.3 PATTERN TEMPO .....                                   | 28        |
| <b>10.2 EDITING A PATTERN .....</b>                          | <b>28</b> |
| 10.2.1 TRIG TYPES .....                                      | 29        |
| 10.2.2 GRID RECORDING MODE.....                              | 29        |
| 10.2.3 LIVE RECORDING MODE .....                             | 29        |
| <b>10.3 MICRO TIMING MENU .....</b>                          | <b>30</b> |
| <b>10.4 RETRIG MENU .....</b>                                | <b>30</b> |
| <b>10.5 PATTERN MENU .....</b>                               | <b>31</b> |
| 10.5.1 RENAME.....   | 31        |
| 10.5.2 CLEAR .....   | 31        |
| 10.5.3 SAVE TO PROJ .....                                    | 31        |
| 10.5.4 RELOAD FROM PROJ.....                                 | 31        |
| 10.5.5 IMPORT/EXPORT.....                                    | 31        |
| <b>10.6 TRIG PARAMETERS PAGE.....</b>                        | <b>32</b> |
| <b>10.7 QUANTIZE MENU .....</b>                              | <b>32</b> |
| <b>10.8 METRONOME MENU .....</b>                             | <b>32</b> |
| <b>10.9 SCALE MENU .....</b>                                 | <b>32</b> |
| 10.9.1 LENGTH PER PATTERN MODE .....                         | 33        |
| 10.9.2 LENGTH PER TRACK MODE .....                           | 33        |
| <b>10.10 MASTER PAGE.....</b>                                | <b>34</b> |
| <b>10.11 SEQUENCER FEATURES.....</b>                         | <b>34</b> |
| 10.11.1 PARAMETER LOCKS.....                                 | 34        |
| 10.11.2 SOUND LOCKS.....                                     | 34        |
| 10.11.3 CONDITIONAL LOCKS.....                               | 34        |
| 10.11.4 FILL MODE.....                                       | 35        |
| 10.11.5 SWING .....  | 36        |
| 10.11.6 COPY, PASTE AND CLEAR OPERATIONS.....                | 36        |
| 10.11.7 TEMPORARY SAVE AND RELOAD PATTERN COMMANDS .....     | 36        |
| <b>10.12 CHAINS.....</b>                                     | <b>37</b> |
| <b>11. AUDIO TRACK PARAMETERS .....</b>                      | <b>38</b> |
| <b>11.1 EDITING THE AUDIO TRACK PARAMETERS.....</b>          | <b>38</b> |
| <b>11.2 TRIG PARAMETERS PAGE .....</b>                       | <b>38</b> |
| <b>11.3 SRC PAGE 1 .....</b>                                 | <b>38</b> |
| <b>11.4 SRC PAGE 2.....</b>                                  | <b>40</b> |
| <b>11.5 FLTR PAGE .....</b>                                  | <b>40</b> |
| <b>11.6 AMP PAGE .....</b>                                   | <b>41</b> |

---

|   |           |
|---|-----------|
| 11.7 LFO PAGE .....   | 42        |
| <b>12. MIDI TRACK PARAMETERS .....</b>                        | <b>45</b> |
| 12.1 EDITING THE MIDI TRACK PARAMETERS .....                  | 45        |
| 12.2 TRIG PARAMETERS PAGE.....                                | 45        |
| 12.3 SRC PAGE .....   | 45        |
| 12.4 FLTR PAGE (CC VALUE) .....                               | 46        |
| 12.5 AMP PAGE (CC SELECT) .....                               | 46        |
| 12.6 LFO PAGE .....   | 47        |
| <b>13. FX PARAMETERS.....</b>                                 | <b>49</b> |
| 13.1 EDITING THE FX PARAMETERS.....                           | 49        |
| 13.2 DELAY.....   | 49        |
| 13.3 REVERB .....   | 50        |
| <b>14. SAMPLING .....</b>                                     | <b>52</b> |
| 14.1 SAMPLING MENU.....                                       | 52        |
| 14.1.1 REC .....  | 52        |
| 14.1.2 ARM .....  | 52        |
| 14.1.3 THR.....   | 52        |
| 14.1.4 SRC .....  | 52        |
| 14.1.5 MON.....   | 52        |
| 14.2 SAMPLING AUDIO .....                                     | 52        |
| 14.3 DIRECT SAMPLING .....                                    | 53        |
| 14.4 ASSIGNING A SAMPLE TO A TRACK FROM THE +DRIVE .....      | 53        |
| 14.5 SAMPLE PLAYBACK .....                                    | 53        |
| <b>15. SETTINGS MENU .....</b>                                | <b>55</b> |
| 15.1 PROJECT .....  | 55        |
| 15.1.1 LOAD PROJECT .....                                     | 55        |
| 15.1.2 SAVE PROJECT AS.....                                   | 55        |
| 15.1.3 MANAGE PROJECTS .....                                  | 55        |
| 15.2 SAMPLES.....   | 55        |
| 15.2.1 LOADING A SAMPLE .....                                 | 56        |
| 15.2.2 UNLOADING A SAMPLE.....                                | 57        |
| 15.2.3 REPLACING A SAMPLE .....                               | 57        |
| 15.2.4 RENAMING A SAMPLE.....                                 | 57        |
| 15.2.5 MOVING A SAMPLE.....                                   | 57        |
| 15.2.6 TRANSFERRING SAMPLES FROM A COMPUTER TO DIGITAKT ..... | 58        |
| 15.2.7 CREATING A NEW DESTINATION DIRECTORY .....             | 58        |
| 15.3 MIDI CONFIG .....  | 59        |
| 15.3.1 SYNC .....   | 59        |
| 15.3.2 PORT CONFIG.....                                       | 59        |
| 15.3.3 CHANNELS.....  | 60        |
| 15.4 SYSEX DUMP .....   | 61        |
| 15.4.1 SYSEX SEND.....  | 61        |
| 15.4.2 SYSEX RECEIVE.....                                     | 62        |
| 15.5 SYSTEM .....   | 62        |
| 15.5.1 OS UPGRADE .....                                       | 62        |
| 15.5.2 FORMAT +DRIVE .....                                    | 63        |
| 15.5.3 STORAGE .....  | 63        |
| <b>16. STARTUP MENU .....</b>                                 | <b>64</b> |
| 16.1 TEST MODE .....  | 64        |

---

|  |           |
|--|-----------|
| 16.2 EMPTY RESET .....                                     | 64        |
| 16.3 FACTORY RESET .....                                   | 64        |
| 16.4 OS UPGRADE.....                                       | 64        |
| 16.5 EXIT .....  | 64        |
| <b>17. SETUP EXAMPLES .....</b>                            | <b>65</b> |
| 17.1 DIGITAKT WITH A MONOPHONIC BASS MACHINE .....         | 65        |
| 17.2 SAMPLING FROM A SMART PHONE .....                     | 65        |
| 17.3 CONTROLLING A SYNTHESIZER USING THE MIDI TRACKS ..... | 66        |
| <b>18. USEFUL KEY COMBINATIONS (QUICK KEYS) .....</b>      | <b>67</b> |
| <b>19. TECHNICAL INFORMATION.....</b>                      | <b>69</b> |
| <b>20. CREDITS AND CONTACT INFORMATION .....</b>           | <b>69</b> |
| <b>APPENDIX A: MIDI .....</b>                              | <b>70</b> |
| A.1 TRACK PARAMETERS.....                                  | 70        |
| A.2 TRIG PARAMETERS .....                                  | 70        |
| A.3 SOURCE PARAMETERS.....                                 | 70        |
| A.4 FILTER PARAMETERS .....                                | 70        |
| A.5 AMP PARAMETERS.....                                    | 70        |
| A.6 LFO PARAMETERS .....                                   | 71        |
| A.7 FX PARAMETERS.....                                     | 71        |
| <b>INDEX.....</b>  | <b>72</b> |

### 1. INTRODUCTION

---

Thank you for purchasing Digitakt. The Digitakt is a compact drum machine from Elektron. It contains all the necessary tools to make people move to the beat. A digital and highly flexible sound engine, sampling capability, a live-friendly sequencer, the means to control external MIDI gear, and Overbridge support. To get the most out of your machine, we recommend that you read this manual in its entirety.

#### 1.1 CONVENTIONS IN THIS MANUAL

We have used the following conventions throughout the manual:

Key names are written in upper case, bold style and within brackets. For instance, the key labeled "FUNC" on the main panel is written as **[FUNC]**.

Knobs are written in upper case, bold, italic letters. For instance, the knob "Level/Data" is called ***LEVEL/ DATA***.

Menu names are written in upper case letters. The SETTINGS menu is an example of that.

Parameter names and certain menu options where settings can be made or actions performed are written in bold, upper case letters. For example, **VOL**.

Upper case letters are used for parameter setting alternatives. For example, **OFF**.

Messages visible on the screen are written in upper case letters with quotation marks. For example, "QUANTIZE LIVE REC".

LED indicators like the Chromatic LED are written like this: <CHROMATIC>.

The following symbols are used throughout the manual:



Important information that you should pay attention to.



A tip that will make it easier for you to interact with the Digitakt.



## 2. THE DIGITAKT

---

When we started thinking about the product that was to become the Digitakt, we began by asking ourselves: what are the ideal features and tools required to quickly make a really good sounding beat? How to define the bare essentials? But not only that. Certain products possess an almost sparkling allure, and they give more than they take. You just want to use them. Why do they evoke such a feeling? And thus, with these questions in mind, the work began.

Fast forward. It's May 2017 and Digitakt will start shipping in about a week. The Elektron HQ is bristling with activity. Factory patterns are being made, tweaks to the Digitakt OS implemented, content for the Elektron website created. Seeing Digitakt in almost complete form is a sight to behold. Now, switch it on. Hopefully you will experience the same thing as we do.

### **The sound.**

Digitakt sounds very good. Audio material handled by the sample engine appears big, full and almost three-dimensional. Sample everything you can. Your studio gear, random clips from YouTube, everyday life. Process and sequence. Digitakt is a sound exploration tool.

### **The workflow.**

The streamlined approach makes beat making a focused activity. Nothing will distract you. This clarity is one of the core features of Digitakt, and gives it a unique character. Being drawn into the Digitakt universe is a very enjoyable experience.

### **The totality.**

Easy sampling, sequencing of both audio and MIDI, the flexible sample engine, and Overbridge support form a very versatile product. The provided feature set allows for depth and adaptability, and also bestows Digitakt with a certain free-spiritedness. Something, somehow, feels alive.

Digitakt is here. And we think we have found the answers to the questions we once asked ourselves.

Sincerely,

The Elektron Team

## 3. PANEL LAYOUT AND CONNECTORS

### 3.1 FRONT PANEL

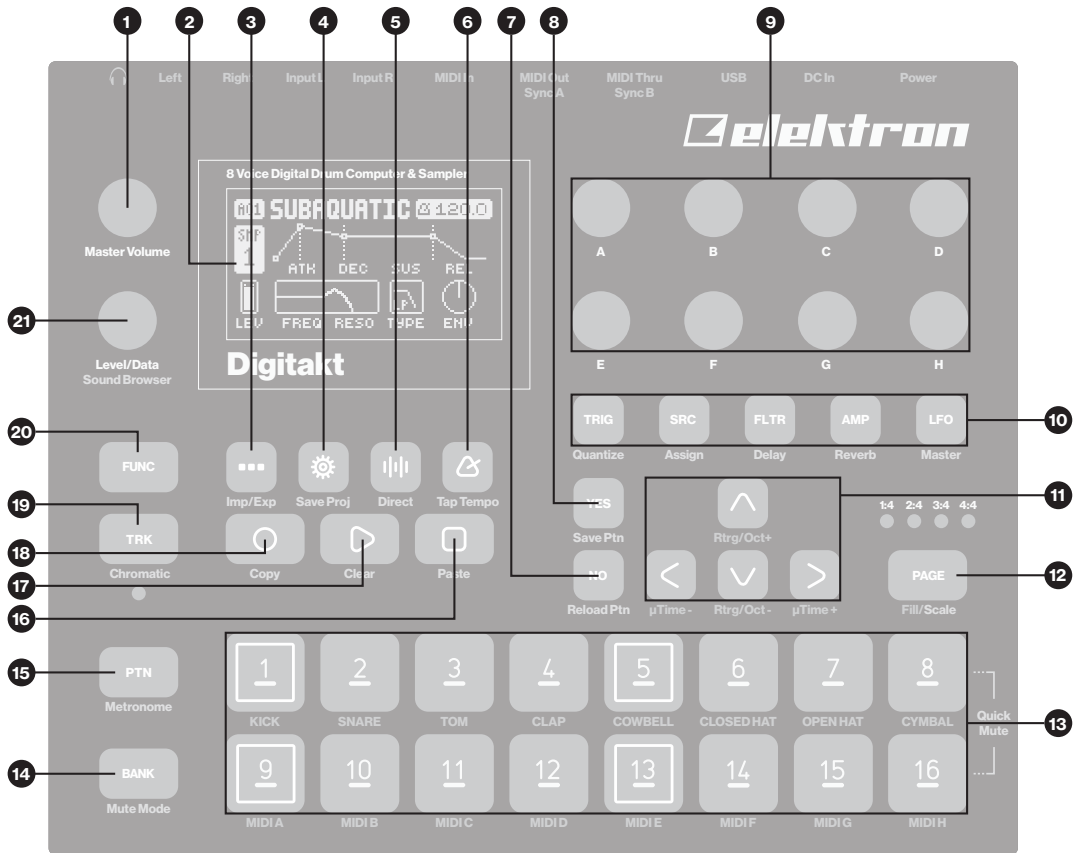

1. **MASTER VOLUME** sets the volume for the main outputs and the headphones output.
2. Screen.
3. **[PATTERN MENU]** opens the PATTERN menu, where pattern management is located. The secondary function accesses the Import/Export menu.
4. **[SETTINGS]** contains the management of projects, MIDI configuration, and the System settings. The secondary function saves the current project.
5. **[SAMPLING]** opens the SAMPLING menu, where you perform the sampling. The secondary function starts Direct Sampling.
6. **[TEMPO]** opens the TEMPO menu, where you can adjust the global/pattern tempo and also adjust the swing. The secondary function makes it possible to tap the tempo.
7. **[NO]** key. Used for exiting an active menu, backing one step and negating. The secondary function is to temporarily reload the active pattern.
8. **[YES]** key. Used for entering sub-menus, selecting and confirming. The secondary function is to temporarily save the active pattern.
9. **DATA ENTRY** knobs **A-H**. Used for setting parameter values. Press and turn the knobs to change values in larger increments.
10. **[PARAMETER]** keys access the PARAMETER pages of the active track. The color of the keys indicates if the page is active (red/orange) or inactive (off).
  - **[TRIG PARAMETERS]** accesses parameters such as **NOTE**, **VELOCITY**, and other trig related parameters. The secondary function accesses the QUANTIZE menu.
  - **[SRC]** takes you to the SOURCE page that deals with sample playback on audio tracks. For MIDI tracks this page has parameters such as **CHANNEL**, **PROGRAM**, and **AFTERTOUCH**. The secondary function accesses SAMPLE SELECT.
  - **[FLTR]** accesses the FILTER page. Here are the parameters for the multimode filter for the audio tracks. On MIDI tracks you find the CC value settings here. The secondary function accesses the DELAY page.

- **[AMP]** takes you to the AMP page, where you find parameters for the amplitude envelope and effect sends. On MIDI tracks you find the CC select settings here. The secondary function accesses the REVERB page.
  - **[LFO]** accesses the LFO parameters for the active track. The secondary function accesses the MASTER page.
11. The **[ARROW]** keys. Used for navigation and for setting some parameter values. In menus, they are called **[UP]**, **[DOWN]**, **[LEFT]**, and **[RIGHT]**.
  12. **[PAGE]** selects the active pattern page, if the pattern is made up of more than 16 steps. The <PATTERN PAGE> LEDs indicate how many pattern pages the active pattern consists of and which pattern page is currently active. The LED flashes on the pattern page currently playing. The secondary function accesses the SCALE menu. This key also activates Fill Mode (when GRID RECORDING mode is not active).
  13. **[TRIG]** keys are used for entering or removing sequencer trigs, and parameter locks, in combination with the **DATA ENTRY** knobs. They are also used to select a track, bank, and pattern, in combination with the **[TRK]**, **[PTN]**, and **[BANK]** keys. The **[TRIG]** keys are also used as a keyboard in CHROMATIC mode. The secondary function is to Quick Mute tracks.  
The **[TRIG]** keys lights indicate trigs on the sequencer by lit red keys, while flashing red keys indicates parameter locks, in GRID RECORDING mode. When a pattern is playing, or when LIVE RECORDING is enabled, a light “runs” along the 16 steps of the sequencer across all (up to four) pages at the set tempo.
  14. **[BANK]** selects bank A–H in combination with the **[TRIG 9–16]** keys. The secondary function accesses the MUTE Mode.
  15. **[PTN]** selects pattern 1–16 in combination with the **[TRIG 1–16]** keys. The secondary function opens the METRONOME menu.
  16. **[STOP]** stops playback. The secondary function is the paste operation.
  17. **[PLAY]** starts the sequencer playback. The secondary function is the clear operation.
  18. **[RECORD]** key. Activates/deactivates GRID RECORDING mode. Keep **[RECORD]** pressed, then press **[PLAY]**, to activate LIVE RECORDING mode. Activate/deactivate QUANTIZATION of LIVE RECORDING by keeping **[RECORD]** pressed, then tapping **[PLAY]** twice. The secondary function is the copy operation.
  19. **[TRK]** key. Press **[TRK]** + one of the **[TRIG]** keys to select a track for editing. The secondary function accesses the CHROMATIC mode.
  20. **[FUNC]** key. Press, hold and press another key to access the secondary function of that key. The secondary functions are written in orange on the Digitakt front panel.
  21. **LEVEL/DATA** sets the overall volume level of the active track. It is also used for setting parameters and scrolling through lists. The secondary function opens the SOUND BROWSER.

#### 3.2 REAR CONNECTORS

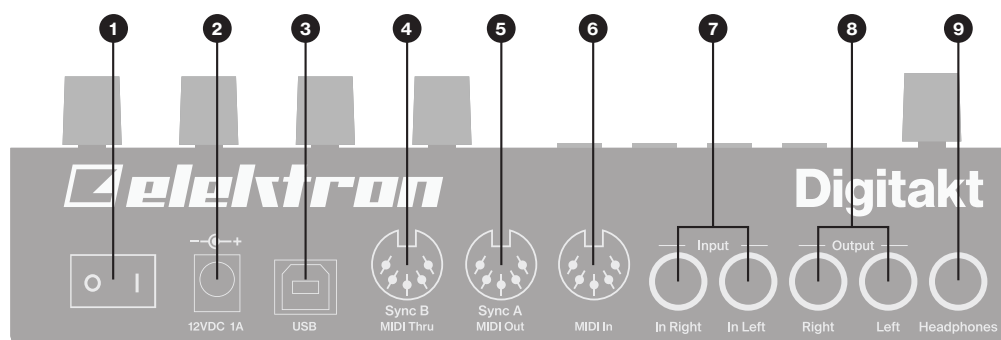

1. **POWER**, Switch for turning the unit on and off.
2. **DC In**, Input for power supply. Use the included PSU-3b power adapter, connected to a power outlet.
3. **USB**, For connecting the unit to a computer. For MIDI-control or Overbridge use. Use the included A to B USB 2.0 connector cable to connect to a computer host.
4. **MIDI THRU/SYNC B**, Forwards data from MIDI IN. Can also be configured to send DIN sync to legacy instruments. Use a standard MIDI cable to connect another MIDI device in the chain.
5. **MIDI OUT/SYNC A**, MIDI data output. Can also be configured to send DIN sync to legacy instruments. Use a standard MIDI cable to connect to MIDI In of an external MIDI device.
6. **MIDI IN**, MIDI data input. Use a standard MIDI cable to connect to MIDI Out of an external MIDI device.
7. **INPUT L/R**, Audio inputs. Use a 1/4" mono phone plug (unbalanced connection).
8. **OUTPUT L/R**, Main audio outputs. Use either 1/4" mono phone plug (unbalanced connection) or 1/4" (Tip/Ring/Sleeve) phone plug (balanced connection).
9. **HEADPHONES**, Audio output for stereo headphones. Use 1/4" (Tip/Ring/Sleeve) phone plug.

#### 3.3 SETTING UP AND STARTING THE DIGITAKT

Make sure you place the Digitakt on a stable support, such as a sturdy table, with sufficient space for the cables. Make sure to switch off all devices before you connect the Digitakt to other devices.

1. Plug the supplied DC adapter to a power outlet and connect the small plug to the 12 V DC In on the Digitakt.
2. Connect OUTPUT L/R from the Digitakt to your mixer or amplifier.
3. To control the Digitakt from a computer, connect a USB cable between the computer and the USB connector of the Digitakt.
4. If you want to use MIDI to control the Digitakt, connect the MIDI OUT port of the device you wish to send data from to the MIDI IN port of the Digitakt. The MIDI THRU port duplicates the data arriving at the MIDI IN port, so it can be used for chaining MIDI units together. Connect the MIDI OUT port of the Digitakt to the MIDI IN port of the device you want to control if you want to use Digitakt to control other devices using MIDI.
5. If you want to sample audio from external sources, connect the audio source to INPUT L/R or via USB.
6. Switch on all units. Switch on the Digitakt by pressing the Power switch located at the back of the unit.

## 4. DIGITAKT SOUND ARCHITECTURE

The illustrations below show the Digitakt sound architecture, with its eight audio voices and two send effects (delay and reverb).

### 4.1 AUDIO VOICES

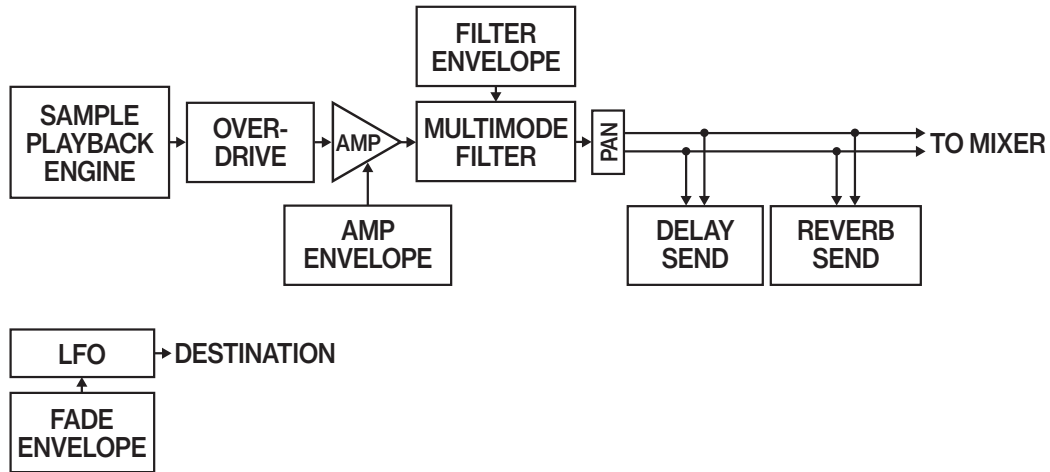

### 4.2 EFFECTS

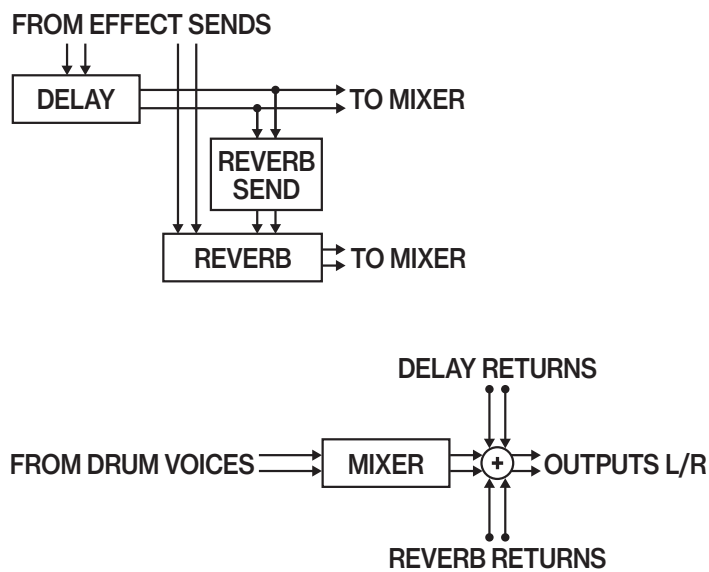

## 5. OVERVIEW OF THE DIGITAKT DATA STRUCTURE

The image below outlines the data structure of the Digitakt.

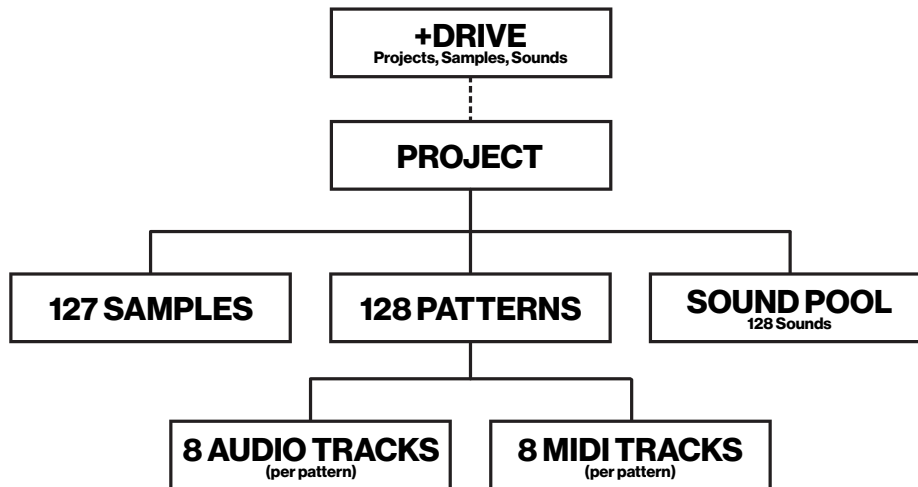

### 5.1 +DRIVE

The +Drive is a non-volatile storage. It keeps up to 128 projects stored internally, and it also holds all saved Sounds. The +Drive also contains the sample bank. All projects have access to these samples.

### 5.2 DATA STRUCTURE

#### 5.2.1 PROJECT

A project contains 128 patterns. General settings and states are also stored in the project. When a project is loaded it becomes the active working state of the Digitakt. From here it is possible to edit the patterns and Sounds of the project. Every time the Digitakt is switched on, it boots to the active working state, the active project. Projects are saved, loaded and managed in the SETTINGS menu. For more information, please see “9. PATTERNS, KITS, SOUNDS, AND SAMPLES” on page 23.

#### 5.2.2 PATTERNS

The patterns are the primary data container for the Digitakt. 16 patterns are available for each of the eight banks, which means that 128 patterns are available for each project. A pattern contains up to eight Sounds (one for each audio track), sequencer data like trigs and parameter locks. It also contains the settings on the TRIG page and BPM, length, swing and time signature settings. The pattern also contains all the parameter settings for the eight MIDI tracks. For more information, please see “10. THE SEQUENCER” on page 28.

#### 5.2.3 SOUNDS

A Sound is a sample, plus all the audio track settings in the SRC, FLTR, AMP, and LFO PARAMETER pages. Sounds are stored in the +Drive Sound library. The +Drive Sound library holds up to 2048 Sounds. You can use the SOUND MANAGER to manage Sounds. For more information, please see “9.3 SOUND MANAGER” on page 24, “9. PATTERNS, KITS, SOUNDS, AND SAMPLES” on page 23, and “11. AUDIO TRACK PARAMETERS” on page 38.



When a Sound is imported to a pattern, it becomes an independent copy of the Sound on the +Drive and is not linked to the original Sound on the +Drive. Instead, it fully becomes a part of the pattern.

#### 5.2.4 SAMPLES

You can load up to 64 MB (about 11 minutes) of samples in a project, using a maximum of 127 sample slots. Samples are stored in the +Drive Sample bank. Additional samples can be transferred to the Digitakt from a computer with the Elektron Transfer software. You also have the possibility to sample straight into the Digitakt.

For more information, please see “14. SAMPLING” on page 52.

## 5.3 ABOUT THE TRACKS

### 5.3.1 THE AUDIO TRACKS

The Digitakt has eight audio tracks. Each audio track contains one sample, and the parameter settings in the **PARAMETER** pages **TRIG**, **SRC**, **FLTR**, **AMP**, and **LFO**.

To select an audio track for editing, press and hold **[TRK]** key and then press one of the **[TRIG 1–8]** keys.

### 5.3.2 THE MIDI TRACKS

The Digitakt has eight dedicated MIDI tracks. They are used to control external, MIDI equipped, gear. Each MIDI track can trigger a chord of up to four notes with adjustable parameters such as velocity and length, control pitch bend and aftertouch, as well as eight freely assignable MIDI control change parameters (MIDI CCs). For more information, please see “12. MIDI TRACK PARAMETERS” on page 45. Any MIDI channel can be assigned to a MIDI track and several tracks can share the same channel. If several tracks are assigned to the same MIDI channel the track with the lowest number has priority regarding parameter conflicts.

The MIDI tracks function almost the same way as the audio tracks. Parameter locks, LFO modulation, copy and paste commands are available. Each MIDI track also features micro timing, individual track length and time signature settings. The main difference is that the MIDI tracks do not generate any sound and the sequencer data is instead transmitted through the MIDI OUT or USB ports.

To select a MIDI track for editing, press and hold **[TRK]** key and then press one of the **[TRIG 9–16]** keys.

### 5.3.3 EDITING THE TRACKS

The five **[PARAMETER]** keys open parameter pages that are used for editing the tracks.

- The **TRIG** page contains different parameters such as **NOTE**, **VELOCITY**, and other trig related parameters.
- The **SRC** page hosts the parameters that deal with sample selection and editing of samples on audio tracks. For MIDI tracks this page has parameters such as **CHANNEL**, **PROGRAM**, and **AFTERTOUCH**.
- On the **FLTR** page, you find parameters for the multimode filter and its filter envelope for the audio tracks. On MIDI tracks you find the CC value settings here.
- The **AMP** page for audio tracks hosts parameters for the amplitude envelope and effect sends. On MIDI tracks you find the CC select settings here.
- Finally, the **LFO** page hosts LFO parameters for the active track.

Use the **DATA ENTRY** knobs A-H to edit the corresponding parameters. Press and turn a knob to adjust its parameter in larger increments. Press and hold a **[PARAMETER]** key to see the values for all parameters on that page. For more information, please see “11. AUDIO TRACK PARAMETERS” on page 38, and “12. MIDI TRACK PARAMETERS” on page 45.

## 6. THE USER INTERFACE

The screen shows all the information needed for real-time interaction and editing on the Digitakt. The eight **DATA ENTRY** knob parameters shown will vary depending on the given situation. Below is the main interface screen of the SRC page.

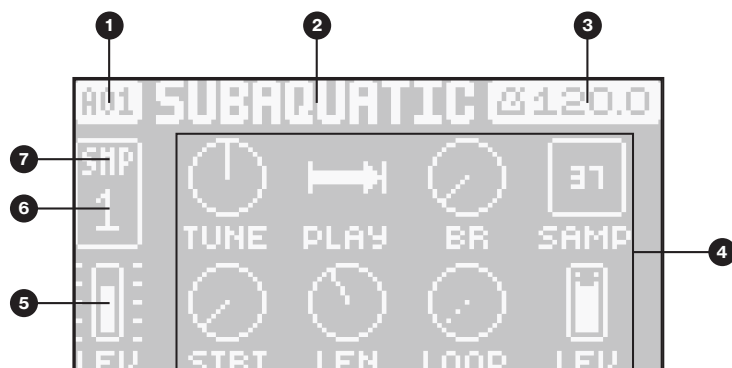

1. The current bank and pattern.
2. The current pattern name.
3. The current tempo.
4. Eight track parameters. They show what the **DATA ENTRY** knobs control and their current parameter values.
5. The main volume setting of the active track. Use the **LEVEL/DATA** knob to change the volume setting.
6. The current active track.
7. Track type. Audio (SMP) track or MIDI (MID) track.

### 6.1 SCREEN NAVIGATION

Use the [ARROW] keys [UP], [DOWN], [LEFT] or [RIGHT] to navigate menus or sub-menus. The **LEVEL/DATA** knob can be used to scroll through menus and lists quickly.

[YES] is used to affirm, select, enter sub-menus and tick/untick boxes.

[NO] is used to negate, deselect or go back one or more steps.



When in a menu or sub-menu, the [NO] key can be used to go back, one step at a time, all the way to the main screen.

### 6.2 PARAMETER EDITING

The **DATA ENTRY** knobs are used to change the values of the track parameters. The positions of the parameters on the screen correspond to the physical locations of the knobs on the front panel. Some of the parameters on the screen tell you what **DATA ENTRY** knob controls that particular parameter. For example "(E)".

- The parameters are adjusted in larger increments if you press down the **DATA ENTRY** knob while turning it. This makes it quicker to sweep through the whole parameter range.
- Press **DATA ENTRY** knob + [NO] to reset the parameter to the default value.
- Press [PARAMETER] key + [PLAY] to reset all the parameters in the selected parameter page to default values.
- Press and hold a [PARAMETER] key to see the values for all parameters on that page.

#### 6.2.1 PARAMETER VALUE JUMP

Pressing [FUNC] while editing certain parameters will make the parameter values jump to appropriate positions. The time of the Delay, for example, will jump between 16, 32, 64 and 128 and the sample tuning will jump whole octaves.

#### 6.2.2 CONTROL ALL

If you press and hold [TRK] and change a parameter setting, this change will affect this parameter in all the audio tracks in the pattern.



### 6.2.3 [FUNC] KEY PRESS COMBINATIONS

The standard way to use the [FUNC] key in combination with other keys, is to press and hold [FUNC] and then make a short press on the second key in the combination. For some key combinations, it is also possible to access a sub-menu by pressing and holding [FUNC] + second key for a second.

## 6.3 QUICK SCROLLING

Scroll through menus using the *LEVEL/DATA* knob. Quick scrolling is possible on many menus. Press [FUNC] + the [UP] or [DOWN] keys to move the cursor one menu page.

## 6.4 COPY, CLEAR, AND PASTE

Copy, clear and paste commands are available in a lot of contexts. Pressing [FUNC] + [RECORD] to copy. Press [FUNC] + [STOP] to paste. Press [FUNC] + [PLAY] to clear. Paste and clear operations is undone by repeating the key press combination. Please see the different sections in the manual for more information on when these commands are available.



The copy clipboard can only hold one item at a time. When you perform a copy command, the item copied replaces any earlier copied items. For example, you can not have both a trig and a pattern copied at the same time.

## 6.5 THE NAMING SCREEN

The naming method is identical for the various naming situations that appear when you save samples, Sounds, projects et cetera.



The [LEFT] and [RIGHT] arrow keys are used to navigate between the characters. Turning the *LEVEL/DATA* knob or pressing the [UP] or [DOWN] arrow keys selects the characters. [FUNC] + [NO] erases characters. [FUNC] + [YES] inserts space. Press and hold [FUNC] to access the Pop-up Naming menu.

### 6.5.1 POP-UP NAMING

A convenient way of naming is to open a pop-up menu that shows all available letters, symbols, and digits. Press and hold the [FUNC] key when you are on the NAMING screen to access the Pop-up Naming screen.



Keep [FUNC] pressed and use the [ARROW] keys to highlight the character you want to insert. Once there, release [FUNC] to add the character.



Copy, paste, and clear commands are available on the NAMING screen.

### 6.6 OVERBRIDGE

The Overbridge software suite enables a tight integration between the Digitakt and a computer DAW.

When using Overbridge, the user interface for the Digitakt will present itself as a clearly laid out plug-in window in your DAW. Access, edit, or automate parameters for sound shaping on screen. Always find your device preset parameters in the same state as you left them when you return to your DAW project, with the convenient total recall functionality.

To use Overbridge, you need a Digitakt, a USB cable, a computer running Overbridge, and a DAW.

**N.B. You must have Digitakt OS 1.10 or later, and Overbridge 1.20 or later to run Overbridge with Digitakt.**

Read more about Overbridge for Digitakt on the Elektron website.

Please read the Overbridge User Manual (available on the Elektron website in the Support section) to learn more about its setup, uses, and capabilities.

## 7. QUICK START

This quick start will guide you through some of the basic operations to start using the Digitakt right away. First, connect it as described in section “3.3 SETTING UP AND STARTING THE DIGITAKT” on page 12.

### 7.1 PLAYING THE FACTORY PRESETS

You can find a number of preset patterns, Sounds, and samples in the Digitakt. Follow the instructions below to get started exploring your new instrument.

1. Press **[BANK]** and then press **[TRIG 9]** key to select bank A. The screen reads “BANK A : SELECT PTN”.
2. Press **[TRIG 1]** key to select the first pattern of bank A.
3. Press **[PLAY]** to listen to pattern A01.
4. Press **[PTN]** and then press **[TRIG 2]** key to select pattern A02. It will start once pattern A01 has reached its end. Select pattern A03 by pressing **[PTN]** and then press **[TRIG 3]** key, and so on.
5. Press **[STOP]** to stop playback.

#### 7.1.1 USING CHROMATIC MODE

You can use the **[TRIG]** keys to play any audio track sample chromatically.

1. Select the audio track to play chromatically by pressing **[TRK]** + one of the **[TRIG 1–8]** keys.
2. Press **[FUNC]** + **[TRK]** to enter CHROMATIC mode. The **[TRIG]** keys will light up in a pattern that resembles an octave of a piano keyboard. Only lit keys are playable.
3. Play the **[TRIG]** keys. The active track Sound will be pitched differently for each of the playable keys. Press the **[ARROW]** keys **[UP]** or **[DOWN]** to transpose the virtual keyboard up or down one octave.

For more information, please see “8.5.1 CHROMATIC MODE” on page 21.



**CHROMATIC mode is an effective way to add musical variety to your beats. The timbre, tonality and impact of playing a Sound chromatically depend on the character of the source Sound.**

#### 7.1.2 USING MUTE MODE

You can mute any of the sequencer tracks in this mode. Unlike the CHROMATIC mode, it makes no difference which track is active when this mode is activated. You can access all tracks simultaneously.

1. Make sure a pattern is playing.
2. Press the **[FUNC]** + **[BANK]** key to enter MUTE mode.
3. Press any of the **[TRIG]** keys to mute the corresponding track. Press again to unmute. The light of the **[TRIG]** keys indicates the mute status. Unlit keys are muted tracks. Lit keys are active tracks.

For more information, please see “8.5.2 MUTE MODE” on page 22.

#### 7.1.3 TEMPO

To change the BPM setting, open the TEMPO menu by pressing the **[TEMPO]** key. Use the **LEVEL/DATA** knob to change tempo. Pressing the knob while turning it changes the tempo eight BPM at a time. The **[ARROW]** keys **[UP]** or **[DOWN]** change the tempo in fractional steps. Note that you can choose between a global tempo or using a separate tempo for every pattern. Press **[FUNC]** + **[YES]** to switch between GLOBAL and PATTERN tempo mode. On the main interface screen, you can also press and hold **[ARROW]** keys **[LEFT]** or **[RIGHT]** to nudge the tempo 10% up or down temporarily. Release the key to revert to the original tempo.

To tap a tempo setting, hold the **[FUNCTION]** key and tap the **[TEMPO]** key in a steady rhythm. After four consecutive taps the average tempo of the taps will be calculated. By continuing tapping, the average tempo will keep on updating.



Nudging the tempo is very handy when manually syncing Digitakt to a turntable or an external sound source. Note that you do not need to be in the TEMPO menu to perform tempo nudging.

#### 7.1.4 EDITING PARAMETERS

Each track has five PARAMETER pages. Press [PARAMETER] keys TRIG, SRC, FLTR, AMP, and LFO to access the different PARAMETER pages. These parameters affect the sound and signal in various ways.

1. Make sure a pattern is playing.
2. Press [TRK] + [TRIG] keys 1-8 to select one of the eight audio tracks.
3. To change, for example, the cutoff of the filter, press the [FLTR] key to open the FILTER page. The parameter labeled **FREQ** changes the cutoff of the filter. Turn **DATA ENTRY** knob **E** to change the parameter value, and hear how the sound is affected.

Try out the rest of the PARAMETER page parameters to explore a variety of sound shaping possibilities.

## 7.2 SAMPLING FROM THE EXTERNAL INPUTS

Digitakt can also sample audio. It can sample audio from external sources, via the external inputs, and it can also sample audio internally from the Digitakt itself.

1. Connect your audio source to the **INPUT L/R** inputs of the Digitakt.
2. Press [SAMPLING] to access the SAMPLING menu and then use **DATA ENTRY** knob **G** to set **SOURCE** to EXT L+R.
3. Keep an eye on the audio input meter and play the audio source and make sure that the volume of the audio source is as strong as possible, but without clipping or distorting. Set **MON** to YES to monitor the incoming audio through the Digitakt.
4. Again, with an eye on the audio input meter and use **DATA ENTRY** knob **F** to set **THRESHOLD** just above the indicated background noise of the audio source (when it is not playing).
5. Press [YES] to arm the sampler and then play the sound source. When the input audio exceeds the set **THRESHOLD** level, sampling will start.
6. Press [YES] when you want to finish the sampling.
7. Use the **DATA ENTRY** knobs **A** and **C** to set the parameters **TRIM START** and **TRIM END** to trim the sample to the desired length. You can use the **DATA ENTRY** knobs **B** and **D** to zoom in and out to make it easier to see where to trim the sample. Press [FUNC] + [YES] to preview the sample.
8. Press [YES] to save the sample.
9. Name the sample and press [YES] again to confirm the save.
10. Press [TRACK 1-8] to select the track to where you want to assign the sample.

For more information, please see “14. SAMPLING” on page 52.

---

## 8. DIGITAKT CONTROLS

---

### 8.1 TRIG KEYS

The **[TRIG]** keys have several uses, including for example, triggering an audio track Sound (track 1–8) from the active pattern. (When sequencer recording is deactivated). They are also used for placing trigs in GRID RECORDING mode. When pressed in combination with the **[PTN]** and **[BANK]** keys, they select patterns and banks. The **[TRIG]** keys light up to indicate the position of placed trigs and to indicate the selected bank and track.

### 8.2 ROTARY ENCODERS

The **MASTER VOLUME** is an absolute encoder, spanning roughly 320 degrees from its left extreme to its right extreme. The **LEVEL/DATA** and **DATA ENTRY** knobs (with which you set various parameter values), are relative encoders which may be spun any number of turns. Pressing and turning these encoders will change their associated values at a greater speed.

### 8.3 KEY BEHAVIOR

As a group, the track selection keys (**[TRIG]** keys) have radio button functionality, i.e. when a new track is set to be active, the previous one is simultaneously deactivated. Only one track can be selected at a time. Likewise, the group consisting of the five **[PARAMETER]** keys have radio button functionality.

The **[FUNC]**, **[TRK]**, **[PTN]**, and **[BANK]** keys must always be used in combination with other keys.

### 8.4 MIDI NOTES

Some functions can be triggered by sending MIDI note values from an external MIDI device (a MIDI keyboard or a computer, for example) connected to the Digitakt via a standard MIDI cable or a USB 2.0 A to B connector cable.

Of the 128 notes in the standard MIDI range, Note numbers 0–8 correspond to notes C0 through to G0, the leftmost octave (which is sometimes called C-2–G-2 in certain applications). These notes will trigger the Sound of track 1 through track 8, respectively (provided they are set to their default channels 1-8). These notes values map to each of the eight tracks, regardless of which track is active.

MIDI note numbers 12–59 (corresponding to notes C1–B4, the second through to fifth octaves in the MIDI range) will trigger the Sound of the active track in any of its 49 chromatic variations (as if played by the **[TRIG]** keys in CHROMATIC mode, see section below), from lowest to highest pitch.

MIDI program change messages 0–127 will select pattern 1–128 (A01–H16) on the Digitakt. Additionally, MIDI CC and NRPN messages can be sent to control various aspects of the Digitakt. For more information, please see “APPENDIX A: MIDI” on page 70.

### 8.5 MODES

There are two special modes of operation on the Digitakt: CHROMATIC mode and MUTE mode.

#### 8.5.1 CHROMATIC MODE

Press **[FUNC]** + **[TRK]** to enter CHROMATIC mode. In this mode, you can play the Sound of the active audio track (or send MIDI notes if you have an active MIDI track) chromatically. The **[TRIG]** keys will light up in a pattern that resembles an octave of a piano keyboard layout. Only lit keys are playable. Press **[TRK]** + **[TRIG 1–16]** keys to select the track you want to play chromatically.

Press the trig keys to change the chromatic note pitch of the Sound. The range from **[TRIG 9]** key to **[TRIG 16]** key is one octave. The whole range for audio tracks spans four octaves: middle, 1 up and 2 down. The whole range for MIDI tracks spans eleven octaves. Press the **[ARROW]** keys **[UP]** or **[DOWN]**, to transpose the virtual keyboard up or down one octave.

Notes triggered chromatically can be recorded on the sequencer in LIVE RECORDING mode. Find out how this is done in section “10.2.3 LIVE RECORDING MODE” on page 29.

The active state of CHROMATIC mode (the portion of the chromatic keyboard currently visible on the **[TRIG]** keys) is not stored per pattern but stays in the state as it was last set.

Press **[FUNC]** + **[TRK]** to exit CHROMATIC mode.



You can also use an external keyboard to play the active tracks Sound chromatically. Connect the keyboard to the Digitakt and configure the external keyboard and the Digitakt MIDI Auto Channel (**SETTINGS > MIDI CONFIG > CHANNELS**) to the same MIDI channel. Then play the keys on the external keyboard to play the active tracks Sound chromatically. You can play the active track's Sound chromatically even if the Digitakt is not in CHROMATIC mode.

### 8.5.2 MUTE MODE

You can use MUTE mode to mute any number of the 16 sequencer tracks. Unlike CHROMATIC mode, it makes no difference which track is active when you enter MUTE mode. All tracks are accessed simultaneously. Press any of the **[TRIG]** keys to mute the corresponding track. Press again to unmute. The color of the **[TRIG]** keys indicates its tracks mute status. Unlit keys signify muted tracks. Lit keys signify unmuted tracks.

There are two different versions of MUTE mode on the Digitakt:

- **GLOBAL MUTE MODE** In GLOBAL MUTE mode, the muted tracks are muted in all patterns, and the trig **[TRIG]** keys are lit green. Press **[FUNC] + [BANK]** to enter GLOBAL MUTE mode. If tracks are muted in GLOBAL MUTE mode, the tracks will flash green when the pattern plays. Press **[FUNC] + [BANK]** to exit GLOBAL MUTE mode.
- **PATTERN MUTE MODE** In PATTERN MUTE mode, the muted tracks are muted only in the active pattern, and the trig **[TRIG]** keys are lit purple. Press **[FUNC] + double-tap [BANK]** to enter PATTERN MUTE mode. If tracks are muted in PATTERN MUTE mode, the tracks will flash purple when the pattern plays. Press **[FUNC] + [BANK]** to exit PATTERN MUTE mode.

The GLOBAL MUTE mode settings are saved together with the project. The PATTERN MUTE mode settings are saved together with the pattern.



You can also use **QUICK MUTE** to easily mute and unmute sequencer tracks. Press and hold **[FUNC]** and then press **[TRIG]** keys to mute or unmute tracks.

Digitakt remembers the last used version of MUTE mode and will access this one first when you press **[FUNC] + [BANK]**.

## 9. PATTERNS, KITS, SOUNDS, AND SAMPLES

The patterns are the primary data container for the Digitakt. Sixteen patterns are available for each of the eight banks, which means that 128 patterns are available for each project. A pattern contains up to eight Sounds (one for each audio track), sequencer data like trigs and parameter locks. It also contains the default settings on the TRIG page and BPM, length, swing and time signature settings. A pattern also contains all the parameter settings for the eight MIDI tracks.

A kit is a collection of eight Sounds. A Sound is a sample, plus all the settings in the PARAMETER pages (SRC, FLTR, AMP, and LFO). A Sound can be assigned to one of the eight audio tracks.

Each of the audio tracks can contain one Sound. A Sound that has been imported from the +Drive to a pattern becomes part of the active pattern. Any changes made to a Sound will therefore not affect the stored Sound or kit. It will only affect the Sound in the active pattern. You can export (and in that way save) a Sound from the active pattern to the +Drive. For more information, please see “9.3 SOUND MANAGER” on page 24.

A sample that is used in a Sound or a pattern can be renamed or moved and still work as intended. This is due to a hash function that adds a file specific value to every file, and this value is independent of the file name or the file's location in the data structure. However, if you delete a sample, it will not be included in any Sounds or patterns anymore.



- When a Sound is imported to a pattern, it becomes a copy of the Sound on the +Drive and is not linked to the original Sound stored on the +Drive. Instead, it fully becomes a part of the pattern.
- If you delete a sample from the +Drive, it will not be included in any Sounds or patterns anymore.

### A Pattern contains:

- A kit.
- All parameter settings for the eight MIDI tracks.
- Sequencer data like trigs and parameter locks.
- The settings on the TRIG PARAMETERS page, BPM, length, swing and time signature settings.

### A Kit contains:

- Eight audio track Sounds.
- LEVEL settings for the audio tracks.

### A Sound contains:

- A sample (linked from the +Drive), plus the SRC, FLTR, AMP, and LFO PARAMETER pages settings for the audio track.

### A Sample contains:

- A 16 bit, 48 kHz, mono audio file.

## 9.1 THE +DRIVE SOUND LIBRARY AND THE SOUND POOL

The total size of the +Drive is 1 GB. The +Drive Sound library can hold up to 2048 Sounds (256 Sounds in each bank A-H) that are available to all projects. The +Drive Sound library also contains the samples. You can load up to 64 MB (about 11 minutes) of samples to a project. A sample must be imported to a project, for it to be Sample locked. For more information, please see “11.3.4 SAMP” on page 39.

Sounds can be loaded to a pattern from either the +Drive Sound library or the Sound pool of the active project. The difference between the two is that the +Drive Sound library has the capacity of 4096 Sounds, available to all projects, while a Sound pool is a part of a project and limited to 128 Sounds. The primary benefit of Sounds loaded to the Sound pool is the possibility for them to be Sound locked. This feature is not available for the Sounds in the +Drive Sound library. For more information, please see “10.1.2 SOUND LOCKS” on page 34.

### 9.1.1 ADDING SOUNDS TO THE SOUND POOL

You must first add Sounds to the Sound pool to be able to perform Sound locks.

1. Press **[FUNC] + [PATTERN MENU]** to open the IMPORT/EXPORT menu.
2. Select **MANAGE SOUNDS**, and then press **[YES]** to open the SOUND MANAGER.
3. Select the Sounds you want to add to the Sound pool by highlighting them and pressing **[YES]**.

4. Press [RIGHT] to open the SOUND OPERATIONS menu.
5. Select COPY TO ... and then press [YES].
6. Select SOUND POOL, and then press [YES].

## 9.2 SOUND BROWSER



Press [FUNC] + LEVEL/DATA to open the SOUND BROWSER. The SOUND BROWSER is used to preview and load Sounds. This menu will show a list of all Sounds in the +Drive Sound library. Scroll the list by turning the LEVEL/DATA knob or by pressing [UP]/[DOWN]. Press [FUNC] + [YES] to preview the Sound before you load it to the track. Press [YES] to load the Sound to the track.

Press [LEFT] to access the SORTING menu. Press [YES] to execute the commands. Press [NO] or the [RIGHT] arrow key to exit the menu.



**VIEW POOL** lists Sounds available in the Sound pool of the active project. The command is only available when you browse the +Drive Sound library.

**VIEW +DRIVE** lists Sounds available on the +Drive Sound library. The command is only available when you browse the Sound pool of the active project.

**SORT ABC** sorts the Sounds in alphabetical order. The command is only available when Sounds are being sorted by slot number.

**SORT 123** sorts the Sounds by slot number. The command is only available when Sounds are being sorted alphabetically.

**FILTER** opens a list where Sounds can be arranged according to tags. Select and deselect tags by pressing [YES]. Multiple tags can be selected. Exit the tag list by pressing [NO].

**SEARCH** will perform a text search and list all Sounds with names matching or including the text input. For more information, please see “6.5 THE NAMING SCREEN” on page 17 on how to enter text.

## 9.3 SOUND MANAGER

Press [FUNC] + [PATTERN MENU] to open the IMPORT/EXPORT menu. The SOUND MANAGER is used to manage Sounds, for example import, export, rename, and tag Sounds. Select **MANAGE SOUNDS** and press [YES] to open the SOUND MANAGER. Sounds can be saved, loaded, renamed, tagged et cetera. Opening this menu will show a list of all Sounds found in the +Drive Sound library. Turn the LEVEL/DATA knob or press [UP]/[DOWN] to scroll through the list. Press [FUNC] + [YES] to preview the Sound before you load it to the track.





Press [LEFT] to access the SORTING menu. Press [YES] to execute the commands. Press [NO] or the [RIGHT] arrow key to exit the menu.

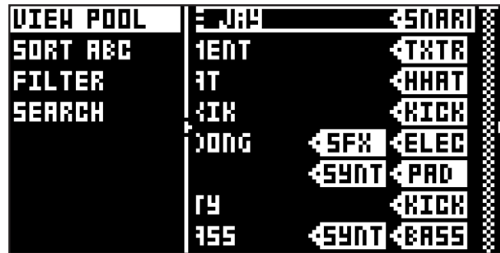

**VIEW POOL** lists Sounds available in the Sound pool of the active project. The command is only available when you browse the +Drive Sound library.

**VIEW +DRIVE** lists Sounds available on the +Drive Sound library. The command is only available when you browse the Sound pool of the active project.

**SORT ABC** sorts the Sounds in alphabetical order. The command is only available when Sounds are being sorted by slot number.

**SORT 123** sorts the Sounds by slot number. The command is only available when Sounds are being sorted alphabetically.

**FILTER** opens a list where Sounds can be arranged according to tags. Select and deselect tags by pressing [YES]. You can select multiple tags. Exit the tag list by pressing [NO].

**SEARCH** will perform a text search and list all Sounds with names matching or including the text input. For more information, please see "6.5 THE NAMING SCREEN" on page 17 on how to enter text.

Press [RIGHT] to access the SOUND OPERATIONS menu. The available operations will affect the highlighted Sound. Press [YES] to apply the commands to the selected Sound. Press [NO] or the [LEFT] arrow key to exit the menu.



**IMPORT TO TRACK** loads the selected Sound to the active track and makes it a part of the active pattern.

**COPY TO...** Copies the selected Sounds to one of the following:

- SOUND POOL copies the selected Sounds to the first free slots of the Sound pool.
- +DRIVE copies the selected Sounds to the first free slots of the +Drive Sound library.
- +BANK (A-H) copies the selected Sounds to the first free slots of a specific bank inside the +Drive.

**EXPORT TO HERE** exports the active track Sound and saves it to the selected slot.

**RENAME** Opens a screen where you can rename the selected Sound.

**EDIT TAGS** opens a menu where Sounds can be tagged. Sounds can have any number of tags, but only the first two will show on the Sound list. Press [YES] to apply or remove tags. Highlight <SAVE> and press [YES] to save

**DELETE** deletes the Sound.

**SELECT ALL** selects all Sounds in the list.

**DESELECT ALL** deselects all Sounds in the list.

**TOGGLE** enables or disables write protection for the selected Sounds. When a Sound is write protected it cannot be overwritten, renamed, tagged or deleted. A write protected Sound has a padlock symbol next to its name

**SEND SYSEX** sends the selected Sounds as SysEx data.



- Sounds in the +Drive Sound library are organized into eight banks, ranging from A to H. Each bank can contain 256 Sounds. Use the [TRIG A–H] keys to view only Sounds located in a specific bank.
- You can preview the currently selected Sound by pressing the [TRIG 1–8] key of the active track. All Sounds available for the active track can be previewed. Please note that if the previewed Sound is sent to the effects, the current effects settings will affect it.
- Several Sounds can be simultaneously affected by the commands available in the SOUND OPERATIONS menu. Select/deselect individual Sounds by highlighting them and pressing [YES].
- Press [FUNC] + [UP]/[DOWN] for faster scrolling in the Sound list.

### 9.4 PLAYING A SOUND

Press the [TRIG 1–8] keys to play the Sounds of the eight tracks of the active pattern. The [TRIG] keys will briefly light up when pressed.

#### PLAYING A SOUND WITH AN EXTERNAL MIDI UNIT

The Sounds can also be played using an external MIDI device connected to Digitakt. The MIDI channels for each of the audio tracks can be assigned in the MIDI CHANNELS menu, covered in the section “15.3.3 CHANNELS” on page 60. You can also use an external MIDI unit to play a Sound chromatically when you are in CHROMATIC mode. For more information, please see “8.5.1 CHROMATIC MODE” on page 21.

### 9.5 EDITING A SOUND

Activate one of the audio tracks for editing by pressing [TRK] + one of the [TRIG] keys 1–8. When editing the settings of the track, any changes made will be stored as part of the active pattern.

Adjust the overall volume level of the active audio track with the **LEVEL/DATA** knob.

Edit a Sound by adjusting the parameters found on the PARAMETER pages. Access these pages by pressing a [PARAMETER] page key. Use the **DATA ENTRY** knobs **A–H** to change the parameters. For more information, please see “11. AUDIO TRACK PARAMETERS” on page 38.

**SRC** controls sample selection and playback of samples.

**FLTR** controls the filter mode, cutoff frequency, and envelope.

**AMP** controls the amplitude parameters, effect sends, and levels.

**LFO** controls parameters for the LFO of the Sound.

If you want to export (save) a particular Sound with all its current parameter settings, use the SOUND MANAGER. For more information, please see “9.3 SOUND MANAGER” on page 24.

The complete Sound, with all its parameter settings and sample, may be copied to another track. Press [TRK] + [RECORD], and then press [TRK] + one of the [TRIG] keys to select the track you want to copy the Sound to, and finally press [TRK] + [STOP] to paste the Sound to the selected track.

### 9.6 ASSIGNING A SAMPLE

Any of the 127 samples loaded to a project may be assigned to a Sound on any of the audio tracks. The user samples can be replaced, relocated and otherwise managed in the SAMPLES menu. For more information, please see “15.2 SAMPLES” on page 55.

1. Press [TRK] + [TRIG 1–8]. To select an audio track to assign the sample to.
2. Press [SRC] to open the SOURCE parameter page.



3. Turn *DATA ENTRY* knob *D* to bring up a list of samples.

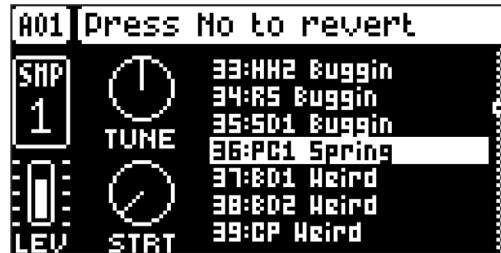

4. Turn the knob counter-clockwise to scroll up the list, clockwise to scroll down the list. Press the **[TRIG]** key of the active track while browsing to listen to the sample currently outlined.
5. Press **[YES]** to select a sample. Press *DATA ENTRY* knob *D* or **[NO]** to exit the list without selecting a sample.

#### 9.6.1 ASSIGNING A SAMPLE USING THE QUICK ASSIGN METHOD

You can also use the Quick assign method to load a sample to a track and the project's Sound pool.

1. Press **[SRC]** to open the SOURCE page, and then turn the knob for the **SAMP** parameter.
2. While the Sample list is open, press **[FUNC] + [YES]** to open the SAMPLES menu. For more information, please see "15.2 SAMPLES" on page 55.
3. Navigate to the sample you want to load. Any sample can be previewed (played back by the voice of the active track), just highlight it and then press **[FUNC] + [YES]**. Approximately, ten seconds of the sample can be previewed.
4. Highlight the sample, and then press **[YES]** to load it directly to the track and the project's Sound pool.

## 10. THE SEQUENCER

The sequencer of the Digitakt stores information in patterns. A pattern controls the playback of the audio tracks, the MIDI tracks and various pattern-specific aspects of the tracks. Each of the eight banks, A to H, contains 16 patterns, which means 128 patterns are available for each project. For more information, please see “10.5 PATTERN MENU” on page 31.

**A pattern contains:**

- General trig settings on the TRIG page (default note pitch, velocity et cetera).
- The parameter settings on the SCR, FLTR, AMP, and LFO pages.
- The settings on the DELAY, REVERB, and MASTER pages.
- Quantization settings.
- Note trigs for all tracks.
- Lock trigs for all tracks.
- Parameter locks.
- Sample locks
- Sound locks.
- Length and time signature for the tracks.

### 10.1 BASIC PATTERN OPERATIONS

Digitakt can seamlessly switch between patterns. This, together with the ability to chain patterns, is a handy feature when improvising live. For more information, please see “10.12 CHAINS” on page 37.

#### 10.1.1 SELECTING BANK AND PATTERN

Press **[BANK]** and then press **[TRIG 9–16]** to select a bank. Then press **[TRIG 1–16]** to select a pattern. Press **[PTN]** and then press **[TRIG 1–16]** to select a new pattern in the current bank. When you press **[BANK]** or **[PTN]** you must choose a bank or pattern within four seconds for the change to take effect. A message on the screen indicates the four second timeout. Press **[TRK]** to exit pattern or bank select.

White **[TRIG]** keys indicate pattern positions that contain data. A red **[TRIG]** key indicates the current active pattern. Empty patterns are unlit.

When a pattern is playing, and a new pattern is selected, the new pattern position will be shown flashing in the upper left corner of the screen. Once the last step of the pattern has played, the new pattern will start, and the pattern position will cease to flash.



- Patterns can be changed while the sequencer is running.
- Patterns can be changed and queued by sending program change messages.
- It is possible to copy, clear and paste one or several patterns at the same time without leaving the active pattern. To copy, press and hold **[PTN]** + **[TRIG]** key to select the pattern you wish to copy. Then press **[RECORD]**. Let go of the **[TRIG]** key and then press and hold the **[TRIG]** key(s) to where you want to paste the pattern. Finally, press and hold **[STOP]** to paste the pattern(s). To clear, press and hold **[PTN]** + **[TRIG]** key(s) to select the pattern(s) you wish to clear. Then press and hold **[PLAY]** to clear the pattern(s).

#### 10.1.2 PATTERN CONTROL

Press **[PLAY]** to start the playback of a pattern. Press **[STOP]** to stop the playback of all tracks. The sound will be cut off, but effects like Delay will continue to be audible until the delay repeats have faded out. When the sequencer has stopped, quickly press **[STOP]** + **[STOP]** to stop playback of all tracks and get just a short fade out the send effects.

When a pattern is playing and **[PLAY]** is pressed, playback will pause. Press **[PLAY]** again to resume the playback.

If a pattern contains more than 16 sequencer steps, the <PATTERN PAGE> LEDs will indicate this. When a pattern is playing, the currently active pattern page is shown with a flashing, <PATTERN PAGE> LED.

#### 10.1.3 PATTERN TEMPO

The tempo is set in the TEMPO menu. Press **[TEMPO]** to open this menu. For more information, please see “7.1.3 TEMPO” on page 19.

### 10.2 EDITING A PATTERN

Digitakt offers two main modes of input when editing or creating a pattern, GRID RECORDING mode and LIVE RECORDING mode. In these modes, two types of trigs can be entered: note trigs and lock trigs.

### 10.2.1 TRIG TYPES

A trig is a sequencer event that you can place when you want the sequencer to perform an action on the Digitakt. There are two types of trigs that you can use, note trigs and lock trigs.

- Note trigs trigger Sounds or MIDI notes.
- Lock trigs trigger parameter locks, but without triggering notes.

Note trigs are indicated by red **[TRIG]** keys and lock trigs are indicated by yellow **[TRIG]** keys. Unlit **[TRIG]** keys indicate steps that does not contain any trigs. Read more about parameter locks in section “10.11.1 PARAMETER LOCKS” on page 34. The two types of trigs are added differently in the sequencer, depending on whether GRID RECORDING or LIVE RECORDING mode is active.

### 10.2.2 GRID RECORDING MODE

GRID RECORDING is a method of composing where you use the **[TRIG]** keys to add trigs.

1. Enter GRID RECORDING mode by pressing the **[RECORD]** key. The **[RECORD]** key lights up red to indicate that GRID RECORDING mode is active.
2. Select the track to which you want to add trigs by pressing and holding **[TRACK]** and then one of the **[TRIG]** keys. A red **[TRIG]** key indicates the active track.
3. Place note trigs on the sequencer using the sixteen **[TRIG]** keys. To add a lock trig, press **[FUNCTION]** and **[TRIG]**. Lock trigs may be entered on any step of the sequencer, including ones that contains note trigs. Quickly pressing the **[TRIG]** key of any of the trigs entered will remove the trig. Pressing a **[TRIG]** key of a trig and holding it slightly longer will prepare the trig for editing, rather than removing it.
4. Select another track, and add note trigs and lock trigs. Repeat the procedure for all the tracks you want to use.
5. Press **[PLAY]** to listen to the sequence.

Add micro timing to a note trig by pressing and holding the **[TRIG]** key while pressing **[ARROW]** keys **[LEFT]** or **[RIGHT]**. For more information, please see “10.3 MICRO TIMING MENU” on page 30.

Set the retrigger speed by pressing and holding the **[TRIG]** key while pressing **[ARROW]** keys **[UP]** or **[DOWN]**. Similarly, a pop-up menu will appear on the screen, where various retrigger settings are made. For more information, please see “10.4 RETRIG MENU” on page 30.

If the pattern contains more than 16 steps, select the pattern page you want to edit by pressing the **[PAGE]** key. A fully lit <PATTERN PAGE> LED shows the active pattern page.

Press **[RECORD]** to exit the GRID RECORDING mode.



- You can use an external MIDI controller such as a keyboard to input NOTE and TRIG VELOCITY data when you are in GRID RECORDING mode. Just press and hold a **[TRIG]** key, and then play a note on the external keyboard. On MIDI tracks, you can add up to a four note chord to every trig. The first note sets the TRIG VELOCITY value for all notes on the trig.
- If you use an external MIDI controller to record to the Digitakt MIDI tracks, the sequencer receives data on the Auto MIDI channel and records on the active track. For more information, please see “15.3.3 CHANNELS” on page 60.
- All trigs of a track can be shifted forwards or backward on the sequencer. While in GRID RECORDING mode, hold down **[FUNC]** while pressing the **[LEFT]** or **[RIGHT]** arrow keys to perform the trig shift.

### 10.2.3 LIVE RECORDING MODE

LIVE RECORDING mode is the second method of adding trigs to the tracks. In this recording mode, the **[TRIG]** keys are played in real time to input trigs to the tracks. You can also use CHROMATIC mode to add note trigs chromatically. It is also possible to enter parameter locks in real time. Trigs input in LIVE RECORDING mode can be automatically quantized or not. Non-quantized trigs can be quantized after they are recorded, by using the QUANTIZE menu that is accessed by pressing **[FUNC]** + **[TRIG]**. For more information, please see “10.7 QUANTIZE MENU” on page 32.

1. Press and hold **[RECORD]**, then press **[PLAY]** to enter LIVE RECORDING mode. Quickly pressing **[PLAY]** twice while keeping the **[RECORD]** key pressed will activate/deactivate automatic quantization of LIVE RECORDING. The sequencer starts to play, and the **[RECORD]** key starts to flash red.

2. Enter trigs in real time by tapping the [TRIG] keys. If CHROMATIC mode is active, the pitch value of the note trig will be recorded according to which [TRIG] key is pressed. Any changes to PARAMETER page settings, using the *DATA ENTRY* knobs, will be recorded as parameter locks and add lock trigs where needed.
3. Press [PLAY] to exit LIVE RECORDING mode while keeping the sequencer playing. If LIVE RECORDING mode is active and [RECORD] is pressed, GRID RECORDING mode will be activated.
4. Press [STOP] to stop both recording and playback of the sequencer.

To exit LIVE RECORDING mode while keeping the sequencer playing, press [PLAY].



- You can use an external MIDI controller such as a keyboard to input NOTE, TRIG VELOCITY, and TRIG LENGTH data in LIVE RECORDING mode. Just play the notes on the external keyboard and they will be recorded by the sequencer. On MIDI tracks, you can add up to a four note chord to every trig. The first note sets the TRIG VELOCITY value for all notes on the trig. The last note that is released sets the TRIG LENGTH for all notes on the trig.

### 10.3 MICRO TIMING MENU

Here you can add micro timing to a note trig, moving it ahead or behind the beat. Micro timing can be customized on any of the sequencer steps on both audio and MIDI tracks. In GRID RECORDING mode, press and hold one or several [TRIG] keys and then press [LEFT]/[RIGHT] to access the pop-up Micro timing menu that shows the time offset for the chosen sequencer step(s) on the active track. To exit the micro timing menu, release the [TRIG] key(s). The micro timing settings are stored in the active pattern



**MICRO TIMING** Press [LEFT]/[RIGHT] keys to adjust the time offset.

### 10.4 RETRIG MENU

Retrigs can be customized on any of the sequencer steps on the audio tracks (the retrigger function is not available on the MIDI tracks). In GRID RECORDING mode, press and hold one or several [TRIG] keys and then press [UP]/[DOWN] to access the pop-up Retrig menu that shows the retrigger actions for the chosen sequencer step(s) on the active track. They are recorded as separate trigs. If the retrigger speed is greater than the duration of a sequencer step, trigs are created with additional internal steps (i.e. steps with retrigger enabled). To exit the Retrig menu, release the [TRIG] key(s). The retrigger settings are stored in the active pattern.



**RETRIG** Turns the retrigger lock ON/OFF. Use *DATA ENTRY* knob A to turn retrigger on/off.

**RATE** Sets the retrigger rate (1/1, 1/2, 1/3, 1/4, 1/5, 1/6, 1/8, 1/10, 1/12, 1/16, 1/20, 1/24, 1/32, 1/40, 1/48, 1/64 or 1/80). 1/16 is the nominal retrigger rate, one trig per step. 1/32 corresponds to two trigs per step and so on. To trig triplets, for example, set the retrigger rate to 1/12 (or 1/24). You can also press the [UP]/[DOWN] keys when you are in the retrigger menu to adjust the rate.

**LEN** Sets the duration of the retrigger velocity curve in fractions of, or rational or integer multiples of, a step (0,125–INF). 1/16 is the nominal length of one step. This setting affects the behavior of the velocity curve by defining the boundaries of its envelope.

**VEL** Sets the velocity curve fade out/fade in of the retrigger (-128–127). -128 corresponds to a complete fade out during the set length, -64 fades out to half the velocity during the set length, 0 equals a flat velocity curve with no fade, 64 fades into half velocity during the set length and 127 fades in completely to full velocity during the set length.

## 10.5 PATTERN MENU

Use the PATTERN menu to perform pattern management. Press [PATTERN MENU] to open the menu. Use the [UP] and [DOWN] arrow keys to move between the options. Press [YES] to confirm your selection. Exit the menu by pressing [NO].



### 10.5.1 RENAME

Opens a NAMING screen where you can rename the active pattern.

### 10.5.2 CLEAR

- **WHOLE PATTERN** Clears the active pattern's sequencer data and kit. A prompt appears when you select this option. Press [YES] to clear, or [NO] to cancel the operation. Note that no pattern information will be permanently lost until the pattern is saved to the same pattern slot that it was loaded from.
- **KIT DATA** Clears the active pattern's kit. All sequencer data will remain unchanged. A prompt appears when you select this option. Press [YES] to clear, or [NO] to cancel the operation. Note that no kit information will be permanently lost until the pattern is saved to the same pattern slot that it was loaded from.
- **SEQUENCE DATA** Clears the active pattern's sequence data. All Sounds will remain unchanged. A prompt appears when you select this option. Press [YES] to clear, or [NO] to cancel the operation. Note that no sequencer information are permanently lost until the pattern is saved to the same pattern slot it was loaded from.

### 10.5.3 SAVE TO PROJ

You must have saved the project at least once before you can save pattern information.

- **WHOLE PATTERN** Saves the active pattern's sequence data and kit to the +Drive. A prompt appears when you select this option. Press [YES] to save, or [NO] to cancel the operation.
- **KIT DATA** Saves the active pattern's kit to the +Drive. A prompt appears when you select this option. Press [YES] to save, or [NO] to cancel the operation.
- **SEQUENCE DATA** Saves the active pattern's sequence data to the +Drive. A prompt appears when you select this option. Press [YES] to save, or [NO] to cancel the operation.

### 10.5.4 RELOAD FROM PROJ

You must have saved the pattern at least once before you can reload pattern information.

- **WHOLE PATTERN** Reloads the active pattern's sequence data and kit from the +Drive. A prompt will appear when you select this option. Press [YES] to reload, or [NO] to cancel the operation.
- **KIT DATA** Reloads the active pattern's kit from the +Drive. A prompt appears when you select this option. Press [YES] to reload, or [NO] to cancel the operation.
- **SEQUENCE DATA** Reloads the active pattern's all sequence data from the +Drive. A prompt appears when you select this option. Press [YES] to reload, or [NO] to cancel the operation.

### 10.5.5 IMPORT/EXPORT

Here you can manage the Sounds on the Digitakt.

- **IMPORT SOUND** Imports (copies) a Sound from the +Drive to the active pattern. Turn the **LEVEL/DATA** knob or press [UP]/[DOWN] to scroll through the list. Press [YES] to select a Sound and then press [TRACK 1–8] to select the track to where you want to assign the Sound.



- **EXPORT SOUND** Exports (saves) the active track's Sound to the +Drive. Turn the *LEVEL/DATA* knob or press [UP]/[DOWN] to choose a destination memory slot. Press [YES] to export the Sound. Name the Sound and press [YES] again to confirm the export.
- **MANAGE SOUNDS** Opens the SOUND MANAGER. For more information, please see "9.3 SOUND MANAGER" on page 24.

## 10.6 TRIG PARAMETERS PAGE

Set the actions for when a note is triggered in the TRIG PARAMETERS page. Press the [TRIG PARAMETERS] key to access the menu. Change settings using the *DATA ENTRY* knobs. These general settings affect note trigs placed on the sequencer. On any step of the pattern, trigs can be locked to other settings by first pressing and holding a [TRIG] key, then changing the settings. For more information, please see "11.2 TRIG PARAMETERS PAGE" on page 38.

## 10.7 QUANTIZE MENU

Press [FUNC] + [TRIG PARAMETERS] to access this menu. Change settings with *DATA ENTRY* knob *E* and *F*.



**TRK.** affects all micro-timed trigs of the active track in real time. The higher the quantize value, the more all micro-timed trigs will be quantized. Press [TRACK 1-4] key to select track to quantize. (0-127)

**GLOBAL** affects all micro-timed trigs of all tracks in real time. The higher the quantize value, the more all micro-timed trigs will be quantized. (0-127)

Press [FUNC] + [YES] to apply quantization to the pattern. Press [NO] to exit the menu.

## 10.8 METRONOME MENU

The METRONOME menu controls the internal metronome of the Digitakt. Press [FUNCTION] + [PTN] to open the METRONOME menu. Use the *DATA ENTRY* knobs to change the settings.



**ACTIVE** activates/deactivates the metronome. You can also press [FUNC] + [PTN] and hold for a second to toggle the metronome on and off when you are not in the METRONOME menu.

**TIME SIG.** controls the note and beat measure of the metronome time signature.

**PREROLL BARS** controls for how many bars the metronome will sound before the sequencer starts playing. This setting is only relevant when you are in LIVE RECORDING mode.

**VOL.** controls the volume of the click.

## 10.9 SCALE MENU

The length and timing of the pattern and tracks is set in this menu. The SCALE menu has two modes. In LENGTH PER PATTERN mode all tracks share the same length. In LENGTH PER TRACK mode each track can have different lengths. Access the SCALE menu by pressing [FUNC] + [PAGE]. Press [FUNC] + [YES] to toggle between the two SCALE modes. Use the *DATA ENTRY* knobs to adjust the different settings.



### 10.9.1 LENGTH PER PATTERN MODE

This is the default mode. In this mode, all tracks of the pattern share the same length and time signature.



**LENGTH** controls the step length of the pattern. The leftmost number displays the number of steps in the pattern. The maximum number of steps available in the pattern is determined by the total length, set by the second number. This can be either 16, 32, 48 or 64 steps. If 17 steps or more are used in a pattern, the **[PAGE]** key is, while in GRID RECORDING mode, used to toggle between the different pattern pages.

**SCALE** controls the time signature of the pattern. It offers seven possible settings, 1/8X, 1/4X, 1/2X, 3/4X, 1X, 3/2X and 2X. A setting of 1/8X will play back the pattern at one-eighth of the set tempo. 3/4X plays the pattern back at three-quarters of the tempo; 3/2X will play back the pattern twice as fast as the 3/4X setting. 2X will make the pattern play at twice the BPM.

Trigs are automatically copied when extending the length of a pattern. If a pattern consists of for example two pages and the pattern length is increased to four pages, the two additional pattern pages will be copies of the first two pattern pages.

Press the **[PAGE]** key to change the total length of the pattern quickly. Press the **[TRIG]** keys to change the number of steps of the pattern quickly.

A 2X time signature setting is useful for increasing the base resolution of the step sequencer to 32nd notes. A 3/4X setting is useful when Digitakt is playing alongside other instruments set to the same BPM, and you want Digitakt to play triplets.

### 10.9.2 LENGTH PER TRACK MODE

In this mode, the tracks of the pattern can be assigned individual lengths. Press **[FUNC] + [YES]** to switch between the two scale modes. In LENGTH PER TRACK mode, two columns exist, TRACK and PATTERN.



The TRACK column sets the step length of the track. It works just like setting the pattern length in LENGTH PER PATTERN mode. The settings will only affect the active track. Press the **[TRK]** keys to select the track whose scale settings will be edited.

The PATTERN column sets the master length, the master change length and the general time signature of the pattern.

**M.LEN** controls the number of steps the pattern will play before all tracks restart. An INF setting will make the tracks of the pattern loop infinitely, without ever being restarted. Note that this setting also affects for how long the active pattern will play before a chained pattern starts playing. The **CH.LEN** parameter can override this.

**CH.LEN** controls for how long the active pattern will play before a cued or chained pattern will begin to play. This setting is important when, for example, **M.LEN** is set to INF. If no **CH.LEN** setting is made, the pattern will play infinitely, and the next pattern will thus not be cued. But if **CH.LEN**, for instance, is set to 64, the pattern will behave like a pattern consisting of 64 steps in terms of cueing and chaining.

**SCALE** sets the general time signature of the pattern.



Press [FUNC] + [UP]/[DOWN] to set the TRACK LENGTH in increments of 16.

## 10.10 MASTER PAGE

Press [FUNC] + [LFO] to access this menu. Here you can conveniently access the TRACK LEVEL parameter of all the eight audio tracks. (0–127)



## 10.11 SEQUENCER FEATURES

### 10.11.1 PARAMETER LOCKS

Parameter locks makes it possible to set every trig to have its own unique parameter values. The note trigs of an audio track can, for example, have different pitch, amp or filter settings. It is possible to parameter lock the parameters found on the PARAMETER pages, and you can apply parameter locks to all types of tracks. For a complete overview of all parameters on the PARAMETER pages, please see “11. AUDIO TRACK PARAMETERS” on page 38, and “12. MIDI TRACK PARAMETERS” on page 45.

To apply parameter locks in GRID RECORDING mode, press and hold the [TRIG] key of a trig (note trig or a lock trig). Use the **DATA ENTRY** knobs to adjust the parameters you want to lock. The graphics become inverted for the locked parameter, and the locked parameter values are displayed. The [TRIG] key of the locked trig blinks red (for note trigs) or yellow (for lock trigs) to indicate the trig now contains a parameter lock.

Remove a single parameter lock by holding [TRIG] + pressing the **DATA ENTRY** knob of the locked parameter. You can erase all parameter locks from a trig if you remove the note trig and then enter it again.

In LIVE RECORDING mode, turning a **DATA ENTRY** knob, or playing the [TRIG] keys in CHROMATIC mode, will input parameter locks to the active track. Note trigs will be locked accordingly, and lock trigs containing the locks will be placed on the sequencer steps not containing note trigs.

Press [NO] + one (or several) of the [TRIG] keys to erase a sequence of recorded trigs on a specific track (or on several tracks) in time with the sequencer, i.e. all steps reached on the pattern playing will be erased until the keys are released.

You can also remove specific parameter locks on a track in real time. In LIVE RECORDING mode, press and hold [NO] and then press and hold the **DATA ENTRY** knob corresponding to the parameter that you want to remove.



Up to 72 different parameters can be locked in a pattern. A parameter counts as one (1) locked parameter no matter how many trigs that lock it. If for example the cutoff parameter of the filter is locked on every sequencer step, there are still 71 other parameters that can be locked.

### 10.11.2 SOUND LOCKS

You can change a tracks Sound to another Sound from the Sound pool on any individual sequencer step. These Sound locks are an immensely useful feature for adding variations to a track. Press and hold a note trig and turn the **TRACK LEVEL** knob to open the Sound pool list. Use the **TRACK LEVEL** knob to scroll through the list. Select the Sound you want to assign to the note trig and then release the [TRIG] key. The [TRIG] key starts to flash to indicate that it contains a Sound lock. Press and hold the [TRIG] key of the note trig to show the assigned Sound. For more information, please see “9.1.1 ADDING SOUNDS TO THE SOUND POOL” on page 23.

### 10.11.3 CONDITIONAL LOCKS

On the TRIG page, there is a parameter called **COND** (Trig Condition) with which a set of conditional rules can be applied to any trig, using a parameter lock. Each setting is a logical condition that will determine whether a trig set in the sequencer will be triggered or not. If the condition is true then the trig will

become active and affect the sequence. You must first place a trig on the sequencer step to where you want to apply a conditional lock.

The sequencer needs to be in FILL mode to activate the conditional lock called FILL. For more information, please see “10.11.4 FILL MODE” on page 35.

You can use the **COND** parameter to set the following trig conditions:

**FILL** is true (activates the trig) when FILL mode is active.

$\overline{\text{FILL}}$  is true when FILL is false. A trig with this trig condition is active when you are not in FILL mode.

**PRE** is true if the most recently evaluated trig condition on the same track was true. ( $\text{PRE}$  and  $\overline{\text{PRE}}$  conditions are ignored and not evaluated.)

$\overline{\text{PRE}}$  is true when PRE is false. A trig with this trig condition is active if the most recently evaluated trig condition on the same track was not true. ( $\text{PRE}$  and  $\overline{\text{PRE}}$  conditions are ignored and not evaluated.)

Example 1: Trig 1, 50% = True > Trig 2,  $\overline{\text{PRE}}$  = False > Trig 3,  $\overline{\text{PRE}}$  = False > Trig 4, PRE = True

Example 2: Trig 1, 50% = False > Trig 2,  $\overline{\text{PRE}}$  = True > Trig 3,  $\overline{\text{PRE}}$  = True > Trig 4, PRE = False

**NEI** is true if the most recently evaluated trig condition on the neighbor track was true. ( $\text{PRE}$  and  $\overline{\text{PRE}}$  conditions on the neighbor track are ignored and not evaluated.) The neighbor track is the track before the active track. For example, track 3 is the neighbor track of track 4. NEI and  $\overline{\text{NEI}}$  conditional trigs on track 4 evaluate the conditional trigs placed on track 3. The NEI condition is false if no conditional trigs exist on the neighbor track.

$\overline{\text{NEI}}$  is true when NEI is false. A trig with this trig condition is active if the most recently evaluated trig condition on the neighbor track was not true. ( $\text{PRE}$  and  $\overline{\text{PRE}}$  conditions on the neighbor track are ignored and not evaluated.)

**1ST** is true the first time the pattern plays (when looped).

$\overline{\text{1ST}}$  is true when 1ST is false. A trig with this trig condition is always active apart from the first time the pattern plays (when looped).

**X%** is a probability condition. There is an x% chance that the trig will be active.

**A:B** A sets how many times the pattern plays before the trig condition is true. B sets how many times the pattern plays before the count is reset and starts over again. This cycle then repeats indefinitely.

For example:

With the setting 1:2, the trig condition is true the first time the pattern plays and then the third, the fifth, and so on.

With the setting 2:2, the trig condition is true the second time the pattern plays and then the fourth, the sixth, and so on.

With the setting 2:4, the trig condition is true the second time the pattern plays and then the sixth, the tenth, and so on.

With the setting 4:7 the trig condition is true the fourth time the pattern plays and then the eleventh, the eighteenth, and so on.



- Conditional parameter locks are a great way to add variety to a pattern. To set up a grid of mutually exclusive or conclusive note trigs across any of the synth tracks, and throwing some probability locks in there as well (perhaps, in turn, also sporting an array of logically conditioned trigs), is a neat way to make the most minimal of compositions come alive with randomness.
- Note that random or arbitrary variety, while fun and interesting, is not the only way of using conditional trigs. They may also be used, for example, to have two different melodic or percussive sequences on the same track, one of which is activated only when FILL mode is active.

#### 10.11.4 FILL MODE

FILL mode can be used to create a temporary variation, such as a drum fill, in your pattern.

Press **[YES]** + **[PAGE]** to activate FILL mode for one pattern cycle. It will become active when the pattern loops, and remain active until it loops again. You can also activate FILL mode at any time, and for any duration, by pressing and holding the **[PAGE]** key when the pattern is playing (GRID RECORDING mode cannot be active). The FILL mode is active for as long as the key is held.

Press and hold **[PAGE]** + **[YES]**, and then release **[PAGE]** before you release **[YES]** to latch FILL mode. Press **[PAGE]** again to unlatch FILL mode.

### 10.11.5 SWING

Adjust the swing setting of the pattern, to employ a propulsive, rhythmic groove. Press [TEMPO] to access this menu.



Turn **DATA ENTRY** knob **E** to set the SWING ratio to 51-80%. The default setting is equal spacing, 50%.

### 10.11.6 COPY, PASTE AND CLEAR OPERATIONS

Patterns, tracks, track pages, and trigs can be copied, pasted and cleared.

The active pattern can be copied to another location in the same bank or in another bank. To perform a pattern copy operation, GRID RECORDING mode must be deactivated. Copy the pattern by pressing [FUNC] + [RECORD]. Select another pattern, and then press [FUNC] + [STOP] to paste the copied pattern to this location. Please note that you can only paste to the currently active pattern. Clear a pattern by pressing [FUNC] + [PLAY].

Individual sequencer tracks can be copied, pasted and cleared in the same way as patterns. To do so, GRID RECORDING mode must be active.

A single track page may also be copied, pasted and cleared. It is similar to copying/pasting/clearing a track, but will only affect the active track page. Select the track page of choice by pressing the [PAGE] key. Copy by pressing [PAGE] + [RECORD]. Select a new track page and press [PAGE] + [STOP] to paste. Press [PAGE] + [PLAY] to clear the active track page.

Trigs, complete with all parameter lock settings, can be copied, pasted and cleared as well. GRID RECORDING mode needs to be active to access this functionality. Press and hold a trig and press [RECORD] to perform the copy operation. Paste by holding another [TRIG] key and pressing [STOP]. It is also possible to copy more than one trig. Hold several trigs and press [RECORD]. The trig first pressed will act as the starting point. When pasting, the other copied trigs will be placed in relation to this trig. Paste the copied sequence of trigs by holding another [TRIG] key and pressing [STOP]. Clear trig locks by holding one or more trigs and press [PLAY].

You can undo any copy, paste, and clear operation by repeating the key presses.



- It is possible to copy, clear and paste one or several patterns without leaving the active pattern. To copy, press and hold [PTN] + [TRIG] key to select the pattern you wish to copy. Then press [RECORD]. Let go of the [TRIG] key and then press and hold the [TRIG] key(s) to where you want to paste the pattern. Finally, press and hold [STOP] to paste the pattern(s). To clear, press and hold [PTN] + [TRIG] key(s) to select the pattern(s) you wish to clear. Then press and hold [PLAY] to clear the pattern(s).

### 10.11.7 TEMPORARY SAVE AND RELOAD PATTERN COMMANDS

Patterns can instantly be saved to a temporary memory space and then reloaded again from this space.

- To perform a temporary save of the active pattern, press [FUNC] + [YES]. This is useful in order to create a restore point when you are live tweaking, but without permanently save your changes.
- To perform a temporary reload of the active pattern, press [FUNC] + [NO]. It will reload the pattern from when you last used the temporary save command. If you have not done any temporary save, then the pattern will reload from the permanently saved state.



The **TEMPORARY SAVE PATTERN** and **TEMPORARY RELOAD PATTERN** commands are great when improvising live. Any changes made to the active pattern, like adding bass line notes or using **CONTROL ALL**, can immediately be undone. And at the same time, the saves and reloads will not affect the pattern in a permanent way.



The **TEMPORARY SAVE PATTERN** command will not save the pattern permanently and any changes will be lost if you load another project. If you wish to save your changes permanently, you should use **SAVE TO PROJ** in the **PATTERN MENU**. For more information, please see "10.5 PATTERN MENU" on page 31.

## 10.12 CHAINS

Chains are sequences that consist of more than one pattern. You can use chains to preselect and automate in what order you want your patterns to play.



You can create one chain in the currently active bank. You can use the 16 patterns within that bank to create the chain. The chain can consist of up to 64 pattern entries.

1. Press **[BANK]** + **[TRIG 9–16]** key to select bank.
2. Press and hold **[PTN]** and then press a **[TRIG 1–16]** key to select the first pattern in the chain.
3. Release the **[PTN]** key and then press **[TRIG 1–16]** keys in the same order as you want the chained patterns to play. Keep the previous **[TRIG]** key pressed while you press the next one, the one after that and so on, so that the sequencer can recognize that you're building a chain and not just switching patterns. You can press the same **[TRIG]** key again if you wish to add the pattern multiple times in a row.
4. Press **[PLAY]** to start the sequencer and play the chain. The chain will be looped once the final pattern of the chain has played.



Please note that the chain will be lost when you create a new chain or when you select a new bank/pattern. Also, chains cannot be saved and will be lost when you switch the Digitakt off.



- Chains can be created while the sequencer is running.
- You can also use MIDI program change messages from an external device to change patterns on the Digitakt. For more information, please see “15.3.1 SYNC” on page 59.

## 11. AUDIO TRACK PARAMETERS

Here follows a description of all of the parameters that are available on the audio tracks PARAMETER pages. The parameters on the TRIG page are not saved together with the Sound, but are instead saved with the pattern. The audio track parameters may be locked to other settings on any step of the pattern by first pressing and holding a [TRIG] key, then changing the parameters' settings with the *DATA ENTRY* knobs. For more information, please see "10.11.1 PARAMETER LOCKS" on page 34.

### 11.1 EDITING THE AUDIO TRACK PARAMETERS

There are five PARAMETER pages for the audio tracks. Press the [PARAMETER] keys to access the audio tracks PARAMETER pages. The SRC parameter group has two pages. To access page one, press the [SRC] key once. To access page two, press the [SRC] key twice. Use the *DATA ENTRY* knobs *A-H* to change the parameters. Press and hold a [PARAMETER] key to see the values for all parameters on that page.

### 11.2 TRIG PARAMETERS PAGE

Set the actions for when a note is triggered. Change settings using the *DATA ENTRY* knobs. These general settings affect note trigs placed in the sequencer.

Press [TRIG PARAMETERS] to access this parameter page.



#### 11.2.1 NOTE

Trig Note sets the pitch of the note when triggered. When in LIVE RECORDING mode and playing in CHROMATIC mode, the pitch of the [TRIG] keys played will override this setting. (-24–+24)

#### 11.2.2 VEL

Trig Velocity sets the velocity of the sequencer's note trigs. (0–127)

#### 11.2.3 LEN

Trig Length sets the length of the note trig. In LIVE RECORDING mode, the duration of pressing the [TRIG] keys overrides this general setting. (0–127, INF)

#### 11.2.4 COND

Trig Condition lets you set a number of conditional rules that can be applied to any trig, using a parameter lock. Each setting is a logical condition, which will determine whether or not the sequencer note will be triggered. For more information, please see "10.11.3 CONDITIONAL LOCKS" on page 34.

#### 11.2.5 FLT.T

Filter Trig controls if the filter envelope will be triggered or not. (ON, OFF)

#### 11.2.6 LFO.T

LFO Trig controls if the LFO will be triggered or not. (ON, OFF)

### 11.3 SRC PAGE 1

The parameters on the SOURCE page control the playback of the user samples. Within each pattern, the samples may be dynamically allocated, modulated and customized. There are 127 sample slots available for every project.

Press [SRC] once to access this parameter page.



### 11.3.1 TUN

Tune sets the pitch of the sample. The knob works in a bipolar fashion, and a value of 0 leaves the pitch unchanged. (-24.00–+24.00, equivalent to four octaves.)

### 11.3.2 PLAY

Play Mode sets the play mode of the sample. It controls how the sample will be played back when it is triggered.

The different modes are:

- **REVERSE** The sample will be played back in reverse once every time it is triggered.
- **REVERSE LOOP** The sample will loop continuously in reverse between Loop Position and Length. How long it will loop for is set with the LEN parameter on the TRIG page. This time is also constrained by the AMP page envelope parameters **HLD** and **DEC**.
- **FORWARD LOOP** The sample starts at the **STRT** position and will loop continuously between Loop Position and Length. How long it will loop for is set with the LEN parameter on the TRIG page. This time is also constrained by the AMP page envelope parameters **HLD** and **DEC**.
- **FORWARD** The sample will be played back once every time it is triggered.

### 11.3.3 BR

Bit Reduction. Increasing the value of this parameter decreases the resolution of the sample, making it more lo-fi. (0–127)

### 11.3.4 SAMP

Sample Select. Here you can browse the list of the up to 127 samples that are loaded to the project, and assign them to the audio tracks. Turn the knob clockwise to scroll down the list, counter-clockwise to scroll up. The first position, OFF, plays no sample. Press [**FUNC**] + [**SRC**] to quickly access this parameter. You must load a sample from the +Drive to the project before you can assign it to a track. For more information, please see “14.4 ASSIGNING A SAMPLE TO A TRACK FROM THE +DRIVE” on page 53. You can apply parameter locks to the SAMP parameter and change the sample on any step of the sequencer, so called Sample locks. For more information, please see “10.11.1 PARAMETER LOCKS” on page 34. (OFF, 1–127).

### 11.3.5 STRT

Start sets the start position for playback of the sample. (0.00–120.00)

### 11.3.6 LEN

Length sets the length of the playback of the sample. Start + Length effectively define the end point of the portion of the sample that is played. (0.00–120.00)

### 11.3.7 LOOP

Loop Pos sets the position in the sample to where playback will return to after reaching the Length Position (defined by **STRT** + **LEN**) of the sample if **PLAY MODE** is set to FORWARD LOOP or REVERSE LOOP. The sample is then looped between the end of **LEN** and **LOOP**. (0.00–120.00)

### 11.3.8 LEV

Sample Level sets the level of the sample. (0.00–127.00)

## 11. AUDIO TRACK PARAMETERS

The STA, LEN, and LOP parameters.

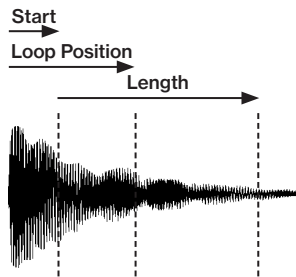

FORWARD LOOP play mode.

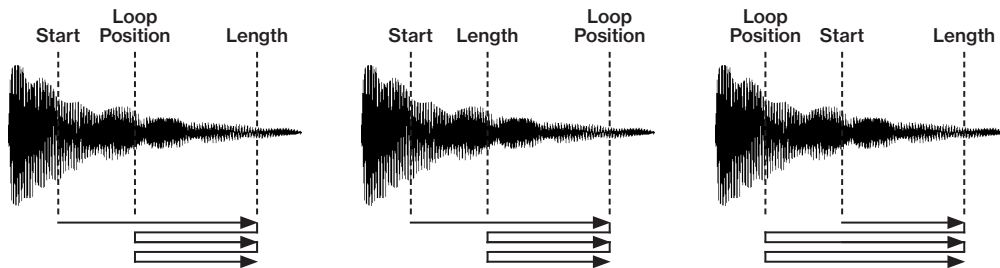

### 11.4 SRC PAGE 2

Same parameters as on SRC page 1 but with a graphical representation of the parameters.

Press [SRC] twice to access this parameter page.



### 11.5 FLTR PAGE

On the FILTER page, you will find all parameters that control the multimode filter and its associated envelope.

Press [FLTR] to access this parameter page.

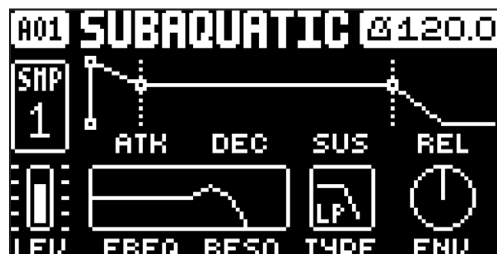

#### 11.5.1 ATK

Attack Time sets the length of the attack phase of the filter envelope. (0-127)

#### 11.5.2 DEC

Decay Time sets the length of the decay phase of the filter envelope. (0-127)

#### 11.5.3 SUS

Sustain Level sets the sustain level of the filter envelope. (0-127)



**11.5.4 REL**

Release Time sets the length of the release phase of the filter envelope. (0–126, INF)

**11.5.5 FREQ**

Frequency sets the cutoff frequency of the multimode filter. (0.00–127.00)

**11.5.6 RESO**

Resonance sets the resonance behavior of the filter. Resonance introduces a peak in the spectrum at the cutoff frequency. (0.00–127.00)

**11.5.7 TYPE**

Filter Type selects the type of filter. (OFF, 2-pole Lowpass, 2-pole Highpass)

**11.5.8 ENV**

Env. Depth sets the amount of cutoff frequency modulation from the filter envelope. The knob is bipolar, both negative and positive modulation depths are available. Range (-64.00–63.00)

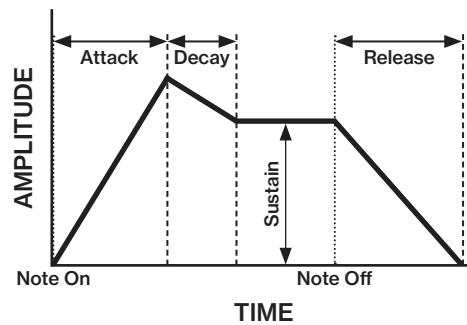
**11.6 AMP PAGE**

The AMP page controls parameters for the amplitude envelope, overdrive, effects sends, panning and volume.

Press [AMP] to access this parameter page.

**11.6.1 ATK**

Attack Time sets the length of the attack phase of the amp envelope. (0–127)

**11.6.2 HOLD**

Hold Time sets the length of the hold phase of the amp envelope. Fixed Hold time values (0–126) specify the length of the hold phase, and the envelope ignores Note Off events such as Trig Length (See “10.6 TRIG PARAMETERS PAGE” on page 32), releasing a [TRIG] key or a key on an external controller. Setting **HOLD** to NOTE means the hold phase will be determined by Note On and Note Off events. (0–126, NOTE)



If you set **HOLD** to NOTE and use an external keyboard to trigger the envelope, then the sound will be sustained for as long as you press a key on the keyboard (or until the sample ends).

**11.6.3 DEC**

Decay Time sets the length of the decay phase of the amp envelope. (0–126, INF)

**11.6.4 OVER**

Overdrive sets the amount of overdrive and clipping distortion of the signal entering the filter. (0.00–127.00)

**11.6.5 DEL**

Delay Send sets the amount of the sound that is sent through to the Delay effect. For more information, please see “13. FX PARAMETERS” on page 49. (OFF, 0.01–127.00)

**11.6.6 REV**

Reverb Send sets the amount of the sound that is sent through to the Reverb effect. For more information, please see “13. FX PARAMETERS” on page 49). (OFF, 0.01–127.00)

**11.6.7 PAN**

Pan positions the sound in the stereo field. The knob function is bipolar with 0 being the balanced mid-point, L64 sends all sound to the left channel and R63 sends all sound to the right. (L64–R63)

**11.6.8 VOL**

Volume sets the amount volume of the sound. This parameter is independent of the overall track level. (0.00–127.00)

Amplitude envelope with a fixed HOLD time.

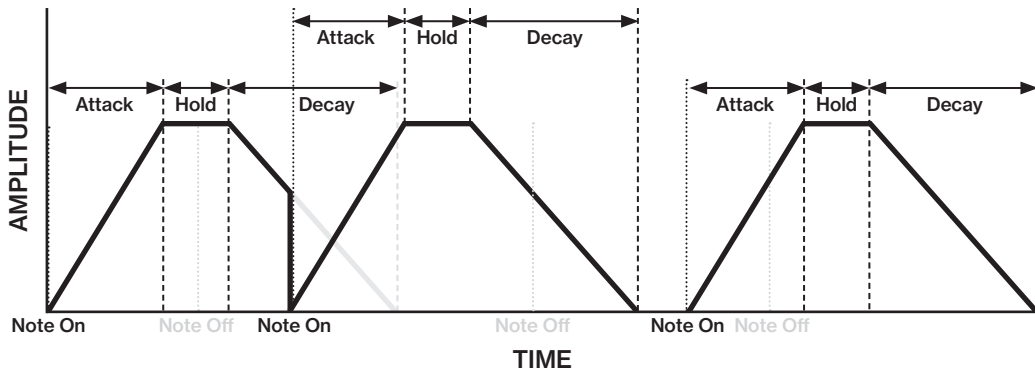

Amplitude envelope with HOLD set to NOTE.

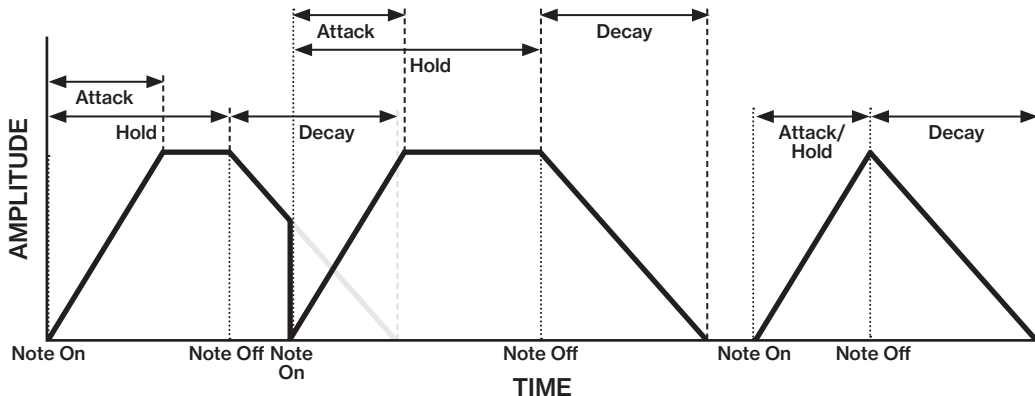

**11.7 LFO PAGE**

The Low-Frequency Oscillator can be used to modulate the parameters found on the audio tracks SRC, FILTER and AMP pages. Customize the low-frequency oscillator behavior, orientation, and depth on this page.

Press [LFO] to access this parameter page.

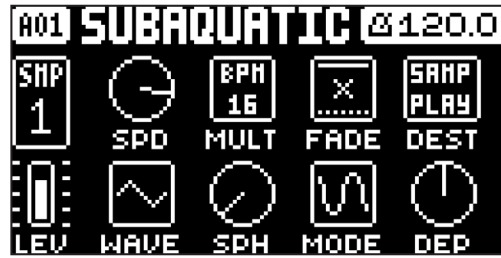

### 11.7.1 SPD

Speed sets the speed of the LFO. Try settings of 8, 16 or 32 to sync the LFO to straight beats. The knob is bipolar. The LFO cycle can be played backward by using negative values. (-64.00–63.00)

### 11.7.2 MULT

Multiplier multiplies the SPD parameter by the set factor either by multiplying the current tempo (BPM settings), or by multiplying a fixed tempo of 120 BPM.

### 11.7.3 FADE

Fade In/Out makes it possible to fade in/fade out the LFO modulation. The knob is bipolar. Positive values give a fade-out, negative values give a fade in. 0 gives no fade in/fade out. (-64–63)

### 11.7.4 DEST

Destination selects the modulation destination for the LFO. Preview how the LFO modulation will affect the sound by highlighting a destination. Press [YES] to confirm the selection.

### 11.7.5 WAVE

Waveform sets the LFO waveform. There are seven waveforms: Triangle, Sine, Square, Sawtooth, Exponential, Ramp, and Random.

### 11.7.6 SPH

Start Phase sets the point within the wave cycle where the LFO will start when it is triggered. 0 makes the LFO start at the beginning of a complete wave cycle, 64 makes it start at the center. (0–127)

### 11.7.7 MODE

Trig Mode sets how the LFO will act when a note is triggered.

- **FRE** is the default free-running mode. It makes the LFO run continuously, never restarting or stopping even if notes are triggered.
- **TRG** makes the LFO restart when a note is triggered.
- **HLD** makes the LFO run free in the background, but when a note is triggered the LFO output level is latched and held still until the next note is triggered.
- **ONE** will make the LFO start from the beginning when a note is triggered, run for one cycle and then stop. This makes its function similar to an envelope.
- **HLF** will make the LFO start from the beginning when a note is triggered, run for half a cycle and then stop.

### 11.7.8 DEP

Depth sets the depth and polarity of the LFO modulation. Both negative (inverted) and positive modulation depth is possible. A center setting, 0.00, equals no modulation depth. (-64.00–63.00)

LFO waveforms and trig modes.

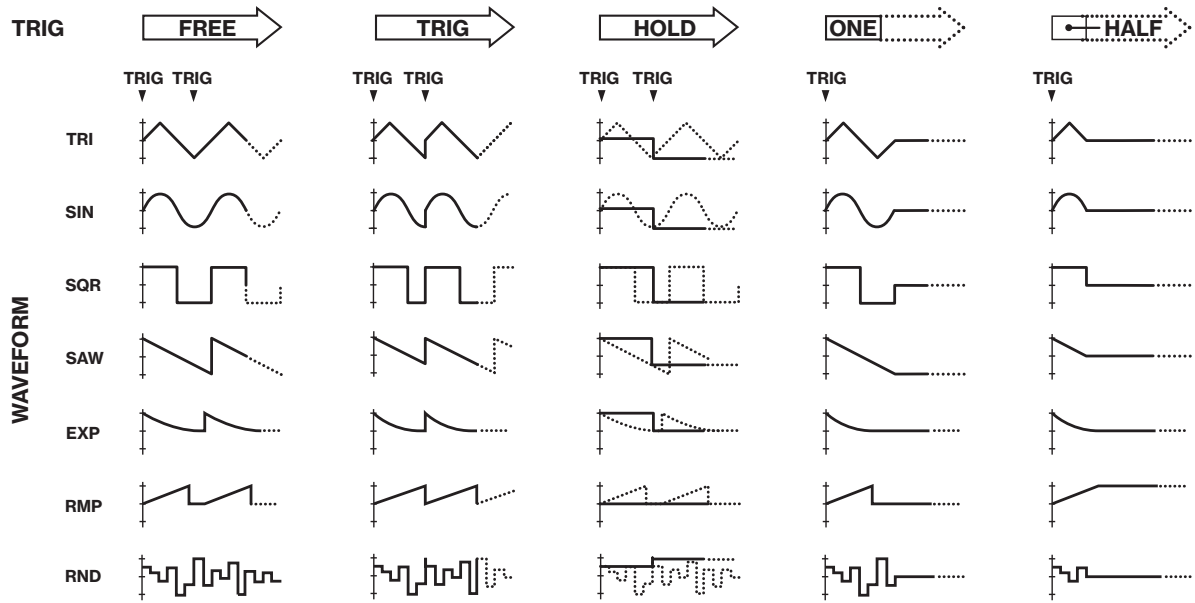

LFO speed (measured in whole note values) generated by combinations of the SPD and MULT settings.

|     |    | MULT |    |     |     |      |      |      |      |       |       |       |        |
|-----|----|------|----|-----|-----|------|------|------|------|-------|-------|-------|--------|
|     |    | 1    | 2  | 4   | 8   | 16   | 32   | 64   | 128  | 256   | 512   | 1K    | 2K     |
| SPD | 1  | 128  | 64 | 32  | 16  | 8    | 4    | 2    | 1    | 1/2   | 1/4   | 1/8   | 1/16   |
|     | 2  | 64   | 32 | 16  | 8   | 4    | 2    | 1    | 1/2  | 1/4   | 1/8   | 1/16  | 1/32   |
|     | 4  | 32   | 16 | 8   | 4   | 2    | 1    | 1/2  | 1/4  | 1/8   | 1/16  | 1/32  | 1/64   |
|     | 8  | 16   | 8  | 4   | 2   | 1    | 1/2  | 1/4  | 1/8  | 1/16  | 1/32  | 1/64  | 1/128  |
|     | 16 | 8    | 4  | 2   | 1   | 1/4  | 1/4  | 1/8  | 1/16 | 1/32  | 1/64  | 1/128 | 1/256  |
|     | 32 | 4    | 2  | 1   | 1/4 | 1/8  | 1/8  | 1/16 | 1/32 | 1/64  | 1/128 | 1/256 | 1/512  |
|     | 64 | 2    | 1  | 1/4 | 1/8 | 1/16 | 1/16 | 1/32 | 1/64 | 1/128 | 1/256 | 1/512 | 1/1024 |

## 12. MIDI TRACK PARAMETERS

Here follows a description of the parameters that are on the MIDI tracks PARAMETER pages. The MIDI tracks parameters are saved together with the pattern. The parameters may be locked to other settings on any step of the pattern by first pressing and holding a [TRIG] key, then changing the parameters settings with the *DATA ENTRY* knobs. For more information, please see “10.11.1 PARAMETER LOCKS” on page 34.

### 12.1 EDITING THE MIDI TRACK PARAMETERS

There are five PARAMETER pages for the MIDI tracks. Press the [PARAMETER] keys to access the MIDI tracks PARAMETER pages. Use the *DATA ENTRY* knobs *A-H* to change the parameters. Press and hold a [PARAMETER] key to see the values for all parameters on that page.

### 12.2 TRIG PARAMETERS PAGE

Set the actions for when a note is triggered. Change settings using the *DATA ENTRY* knobs. These general settings affect note trigs placed in the sequencer.

Press [TRIG PARAMETERS] to access this parameter page.



#### 12.2.1 NOT1

Note 1 sets the root note that should be sent by the MIDI track. (C0–G10)

#### 12.2.2 NOT2–NOT4

Note 2–4 will add more notes, offset from the root note by the selected values, to a note trig. This makes it possible for a MIDI track to send out chords that consists of up to 4 notes. If the root note is changed the offset notes will transpose accordingly. A value of 0 will remove the offset note. (-64–+63)

#### 12.2.3 VEL

Trig Velocity controls the velocity of the notes the MIDI track sends out. A setting of 0 equals a NOTE OFF command. (1–127)

#### 12.2.4 LEN

Trig Length sets the duration of the notes. When a note has finished playing a NOTE OFF command will be sent. The INF setting equals infinite note length. (0.125–128, INF)

#### 12.2.5 COND

Trig Condition is a set of conditional rules that can be applied to any trig, using a parameter lock. Each setting is a logical condition, which will determine whether or not the sequencer note will be triggered. For more information, please see “10.11.3 CONDITIONAL LOCKS” on page 34.

#### 12.2.6 LFO.T

LFO Trig controls if the LFO will be triggered or not. (ON, OFF)

### 12.3 SRC PAGE

Here you can set the MIDI channel that the MIDI track should use to send data. Bank and program change values are also set here, together with a few standard CC parameters. The default value of the parameters on this page is OFF, meaning they are disabled and will not send out any data. Press and hold [FUNC] and then press the *DATA ENTRY* knobs to enable them. You can then use the *DATA ENTRY* knobs to set the parameter values as usual. Disable the parameters again by repeating the activation procedure.

Press [SRC] once to access this parameter page.



**12.3.1 CHAN**

Channel sets the MIDI channel the track will send MIDI data to. If this parameter is set to OFF, it basically turns the MIDI track off. Please note that this parameter cannot be parameter locked. (OFF, 1-16)

**12.3.2 BANK**

Bank is used for sending out a bank change message. Bank 1 to 128 can be sent. (OFF, 1-128)

**12.3.3 PROG**

Program change is used for sending out a program change message. Program 1 to 128 can be sent. (OFF, 0-128)

**12.3.4 PB**

Pitch Bend controls the pitch bend data sent on the MIDI track. (OFF, -128.00-128.00)

**12.3.5 AT**

Aftertouch controls the aftertouch data sent on the MIDI track. (OFF, 0-127)

**12.3.6 MW**

Mod Wheel controls the modulation wheel data sent on the MIDI track. (OFF, 0-127)

**12.3.7 BC**

Breath controller controls the breath control data sent on the MIDI track. (OFF, 0-127)

**12.4 FLTR PAGE (CC VALUE)**

Here you can set the values of up to eight assignable CC commands. The default value of the parameters on this page is OFF, meaning they are disabled and will not send out any data. Press and hold [FUNC] and then press the *DATA ENTRY* knobs to enable them. You can then use the *DATA ENTRY* knobs to set the parameter values as usual. Disable the parameters again by repeating the enabling procedure.

Press [FLTR] to access this parameter page.

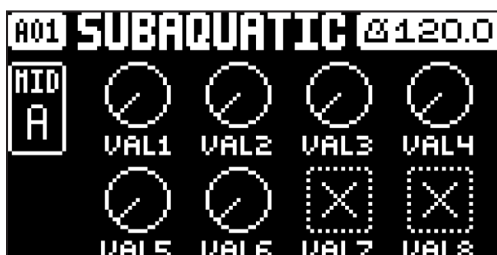

**12.4.1 VAL1-VAL8**

CC 1-8 Value controls the values that are sent for the CC commands, which are specified on the AMP (CC SELECT) page. These parameters default value is OFF. Press [TRIG] + *DATA ENTRY* knobs to activate the parameters and then set a value. (OFF, 0-127)

**12.5 AMP PAGE (CC SELECT)**

Here you select the eight CC commands whose values are controlled by the parameters on the FLTR PAGE (CC VALUE) page. Press the corresponding knob or [ENTER/YES] to activate the parameter change.

Press [AMP] to access this parameter page.



### 12.5.1 SEL1-SEL8

CC 1–8 Select specifies the CC commands that are controlled by the parameters on the AMP PAGE 1 (CC VALUE) page. The selectable values are the standard MIDI Control Change Messages. (0–119)

## 12.6 LFO PAGE

The Low-Frequency Oscillator can be used to interact with the parameters found on the MIDI tracks' SRC, and FLTR pages. Customize the low-frequency oscillator behavior, orientation, and depth on this page.

Press [LFO] to access this parameter page.



### 12.6.1 SPD

Speed sets the speed of the LFO. Try settings of 8, 16 or 32 to sync the LFO to straight beats. The knob is bi-polar. The LFO cycle can be played backward by using negative values. (-64.00–63.00)

### 12.6.2 MULT

Multiplier multiplies the SPD parameter by the set factor either by multiplying the current tempo (BPM settings), or by multiplying a fixed tempo of 120 BPM.

### 12.6.3 FADE

Fade In/Out makes it possible to fade in/fade out the LFO modulation. The knob is bipolar. Positive values give a fade out, negative values give a fade in. 0 gives no fade in/fade out. (-64–63)

### 12.6.4 DEST

Destination selects the modulation destination for the LFO. Preview how the LFO modulation will affect the sound by highlighting a destination. Press [YES] to confirm the selection.

### 12.6.5 WAVE

Waveform sets the LFO waveform. There are seven waveforms: Triangle, Sine, Square, Sawtooth, Exponential, Ramp and Random.

### 12.6.6 SPH

Start Phase sets the point within the wave cycle where the LFO will start when it is triggered. 0 makes the LFO start at the beginning of a complete wave cycle, 64 makes it start at the center. (0–127)

### 12.6.7 MODE

Trig Mode sets how the LFO will act when a note is triggered.

- **FRE** is the default free-running mode. It makes the LFO run continuously, never restarting or stopping even if notes are triggered.
- **TRG** makes the LFO restart when a note is triggered.
- **HLD** makes the LFO run free in the background, but when a note is triggered the LFO output level is latched and held still until the next note is triggered.

- **ONE** will make the LFO start from the beginning when a note is triggered, run for one cycle and then stop. This makes its function similar to an envelope.
- **HLF** will make the LFO start from the beginning when a note is triggered, run for half a cycle and then stop.

For more information about the Trig Modes, please see the illustration at the end of section “11.7 LFO PAGE” on page 42.

### **12.6.8 DEP**

Depth sets the depth and polarity of the LFO modulation. Both negative (inverted) and positive modulation depth is possible. A center setting, 0.00, equals no modulation depth. (-64.00–63.00)



## 13. FX PARAMETERS

The Digitakt effect parameters are explained in this chapter.

### 13.1 EDITING THE FX PARAMETERS

The Digitakt's Delay and Reverb are send effects and are set on a pattern level. It means that all the Sounds in a pattern shares the same effect settings but have individual send levels to the effects. The Delay and Reverb parameters are set on their respective PARAMETER page, but their incoming signals are set by the DEL and REV send parameters on the AMP page of each audio track. Press [FUNC] + [FLTR] to edit the Delay. Press [FUNC] + [AMP] to edit the Reverb. Use the **DATA ENTRY** knobs **A-H** to change the parameters.

**DELAY** controls the character, reverb send and volume of the delay send effect.

**REVERB** controls the character and volume of the reverb send effect.



- The FX parameter settings are stored as part of the pattern. Don't forget to save the pattern and give it a unique name once you have achieved the results you want.

### 13.2 DELAY

The Delay send effect takes the input signal, delays it in time and then rejoins it with the original signal.

Press [FUNC] + [FLTR] to access this parameter page.



#### 13.2.1 TIME

Delay Time sets the delay time. It is relative to the current BPM and is measured in 128th notes. (1.00–128.00)

| TIME setting | Divide ratio |
|--------------|--------------|
| 1            | 1/128        |
| 2            | 1/64         |
| 2.67         | 1/48 (1/32T) |
| 3            | 1/64.        |
| 4            | 1/32         |
| 5.33         | 1/24 (1/16T) |
| 6            | 1/32.        |
| 8            | 1/16         |
| 10.67        | 1/12 (1/8T)  |
| 12           | 1/16.        |
| 16           | 1/8          |
| 21.33        | 1/6 (1/4T)   |
| 24           | 1/8.         |
| 32           | 1/4          |
| 42.67        | 1/3 (1/2T)   |
| 48           | 1/4.         |
| 64           | 1/2          |
| 96           | 1/2.         |
| 128          | 1            |

### 13.2.2 X

Ping-pong sets the delay signal to alternate across the stereo field. There are two settings:

- **OFF** lets you manually set the position of the delay signal in the stereo field. Use the WID parameter to change the stereo field position.
- **ON** makes the delay signal alternate between left and right pan positions. The WID parameter controls the amount of panning.

### 13.2.3 WID

Stereo Width sets the delay signal pan width across the stereo field. The knob is bipolar. (-64.00–63.00)

### 13.2.4 FDBK

Feedback Gain sets the amount of delay output signal to feed back into the input of the delay. With higher parameter settings, infinite and/or swelling delays are possible. Please be aware that high feedback can lead to a very loud signal. (0–198)

### 13.2.5 HPF

Feedback HPF sets the cutoff frequency of the delay highpass filter. (0.00–127.00)

### 13.2.6 LPF

Feedback LPF sets the cutoff frequency of the delay lowpass filter. (0.00–127.00)

### 13.2.7 REV

Reverb Send sets the amount of Delay output signal to be sent to the Reverb. (0.00–127.00)

### 13.2.8 VOL

Mix Volume adjusts the volume of the Delay output signal. (0.00–127.00)

## 13.3 REVERB

The Reverb send effect controls the persistence, and ambient characteristics, of the sound reverberations. It can simulate many different sonic locations, from huge spaces to small rooms.

Press **[FUNC]** + **[AMP]** to access this parameter page.

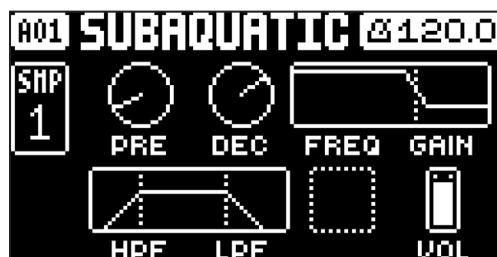

### 13.3.1 PRE

Pre-delay sets the pre-delay time of the Reverb. (0.00–127.00)

### 13.3.2 DEC

Decay Time sets the length of the decay phase of the reverberated signal, essentially setting the size of the acoustic space. (1–127, INF)

### 13.3.3 FREQ

FB Shelving Freq sets the shelving filter frequency. Together with the GAIN parameter, it can be used to dampen the reverberated signal above a chosen frequency, making the reverberation sound more prominent or more muffled. (0.00–127.00)

### 13.3.4 GAIN

FB Shelving Gain affects the damping of the reverberated signal above the shelving frequency set by the FRQ parameter. At max value the treble is included in the reverberations; lowering the value gradually dampens it. (0.00–127.00)

### 13.3.5 HPF

Input HPF sets the cutoff frequency of the reverb high-pass filter. (0.00–127.00)

**13.3.6 LPF**

Input LPF sets the cutoff frequency of the reverb low-pass filter. (0.00–127.00)

**13.3.7 VOL**

Mix Volume sets the volume of the Reverb output signal. (0.00–127.00)

## 14. SAMPLING

Digitakt is a very competent and accessible sampler. It can sample audio from external sources via the external inputs, and it can also sample audio internally from the Digitakt itself. The maximum sampling time is 33 seconds and this is always available even if a project's 64 MB of RAM memory is all used up.

### 14.1 SAMPLING MENU

The SAMPLING menu offers settings that control the different aspects of sampling.

Press [SAMPLING] to access this menu. Use the *DATA ENTRY* knobs to change the parameters.



#### 14.1.1 REC

Press [FUNC] + [YES] to start sampling. Press [YES] to stop sampling.

#### 14.1.2 ARM

Press [YES] to arm the sampler. The sampler is now in arm mode and it will start sampling when the incoming audio exceeds the threshold level. See below. (Press [SAMPLING] + [NO] to cancel.)

#### 14.1.3 THR

If you have selected to arm the sampler, the sampling begins when the incoming audio signal exceeds the threshold setting. Set the threshold high enough so that it is not triggered by background noise, but low enough that you capture all of the signal. (0-127)

#### 14.1.4 SRC

Source selects between different incoming audio sources to sample from.

- EXT L sets the input source to INPUT L.
- EXT R sets the input source to INPUT R.
- EXT L+R sets the input source to INPUT L+R. The audio is summed together to mono.
- INT L sets the input source to the Digitakt internal audio left channel.
- INT R sets the input source to the Digitakt internal audio right channel.
- INT L+R sets the input source to the Digitakt internal audio L+R channels. The audio is summed together to mono.

#### 14.1.5 MON

Selects the option to monitor the incoming audio through the Digitakt or not. (NO, YES)

### 14.2 SAMPLING AUDIO

1. If you use an external audio source, connect it to the Digitakt.
2. Press [SAMPLING] to access the SAMPLING menu and then use *DATA ENTRY* knob **G** to set **SOURCE** to your preferred audio input source.
3. Keep an eye on the audio input meter and play the audio source and make sure that the volume of the audio source is as strong as possible, but without clipping or distorting. Set **MON** to YES to monitor the incoming audio through the Digitakt.
4. Again, with an eye on the audio input meter, use *DATA ENTRY* knob **F** to set **THR** just above the indicated background noise of the audio source (when it is not playing).
5. Press [YES] to arm the sampler and then play the sound source. When the incoming audio signal exceeds the set threshold level, sampling will start.
6. Press [YES] when you want to stop sampling. The Digitakt then automatically normalizes the sample.

- Use the **DATA ENTRY** knobs **A** and **C** to set the parameters **TRIM START** and **TRIM END** to trim the sample to the desired length. You can use the **DATA ENTRY** knobs **B** and **D** to zoom in and out to make it easier to see where to trim the sample. Press **[FUNC] + [YES]** to preview the sample. Press **[YES]** to trim the sample. After you have trimmed the sample, you can press **[NO]** to untrim the sample if you are not happy with the result.



- Press **[YES]** to save the sample.
- Name the sample and press **[YES]** again to confirm the save.
- Press **[TRACK 1–8]** if you want to select a track to where you want to assign the sample. Press **[NO]** if you don't want to assign the sample to a track.

### 14.3 DIRECT SAMPLING

You can also perform sampling without using the SAMPLING menu. This is achieved by a set of key press combinations. The sampler will use the **SRC** and **THR** settings that were last used.

- Press **[SAMPLING] + [YES]** to arm the sampler. The **[SAMPLING]** key turns yellow. You can also start direct sampling without arming the sampler first. Press **[FUNC] + [SAMPLING]** to manually start sampling.
- When the incoming audio signal exceeds the set threshold level (or you manually start direct sampling), the sampling starts, and the **[SAMPLING]** key turns red.
- Press **[FUNC] + [SAMPLING]** again to stop sampling. The **[SAMPLING]** key first turns dark red while normalizing the sample, then green when it is done.

Press **[SAMPLING] + [NO]** to cancel at any stage of the Direct Sampling process.

### 14.4 ASSIGNING A SAMPLE TO A TRACK FROM THE +DRIVE

You can also assign samples from the +Drive storage in the Digitakt to the tracks.

- Press **[SETTINGS]** to access the SETTINGS menu, and then select SAMPLES and press **[YES]**.
- Use the **[ARROW]** keys to navigate to the sample you want to assign, and then press **[YES]** to select the sample.
- Press **[RIGHT]**, and then select LOAD TO PROJ and press **[YES]** to copy and load the sample to the project.
- Press **[YES]** to confirm.
- Press **[FUNC] + [SETTINGS]** to exit SETTINGS menu.
- Press **[TRACK] + [TRIG 1–8]** to select the track to where you want to assign the sample.
- Press **[SRC]** access the SOURCE menu, and then use **DATA ENTRY** knob **D** to select the sample you want to load.
- Press **[YES]** to load the sample to the track.

For more information, please see “15.2 SAMPLES” on page 55.

### 14.5 SAMPLE PLAYBACK

Once the sample is assigned to a track, it can be triggered either by the sequencer or manually by pressing a **[TRIG]** key. You also have the ability to set the samples play mode and edit what portion of the sample is played.

- Press **[SRC]** to access the SOURCE page.
- Use **DATA ENTRY** knob **B** to set the **PLAY MODE** behavior of the sample.
  - REVERSE** The sample will be played back in reverse once every time it is triggered.

- **REVERSE LOOP** The sample will loop continuously in reverse between Loop Position and Length. How long it will loop for is set with the LEN parameter on the TRIG page. The loop time is also constrained by the AMP page envelope parameter settings **HLD** and **DEC**.
  - **FORWARD LOOP** The sample will loop continuously between Loop Position and Length. How long it will loop for is set with the LEN parameter on the TRIG page. The loop time is also constrained by the AMP page envelope parameters **HLD** and **DEC**.
  - **FORWARD** The sample will be played back once every time it is triggered.
3. Use **DATA ENTRY** knobs **E**, **F**, and **G** to set the **STRT**, **LEN**, and **LOOP** parameters which define what portion of the sample is played. Press [**SRC**] twice to access SRC page 2, in order to more easily see these settings using the sample waveform. For more information, please see “11.4 SRC PAGE 2” on page 40.



4. • **STRT** Start sets the start position for the playback of the sample.
- **LEN** Length sets the length of the playback of the sample. Start + Length effectively defines the end point of the portion of the sample that is played.
  - **LOP** Loop Position sets the position in the sample to where playback will return after reaching the Length Position (defined by **STRT** + **LEN**) if **PLAY MODE** is set to **FORWARD LOOP** or **REVERSE LOOP**. The sample then loops between the end of **LEN**, and **LOOP**.

For more information, please see “11.3 SRC PAGE 1” on page 38.

## 15. SETTINGS MENU

The SETTINGS menu offers settings that affect Digitakt and can also be used to manage Projects.

Press **[SETTINGS]** to access the SETTINGS menu. Scroll the list by using **[UP]/[DOWN]** or the *LEVEL/DATA* knob. Open a highlighted menu by pressing **[YES]**.



### 15.1 PROJECT



#### 15.1.1 LOAD PROJECT

Load Project opens a project selection screen where you can choose a project to load. Note that the active project will not be saved before loading the new project so remember to save the active project first. If you wish to create a new project, select CREATE NEW at the very bottom of the list. The new project will be a blank slate.



If you load a new project it will overwrite the active project. Be sure to save your active project before you load another project.

#### 15.1.2 SAVE PROJECT AS

Save Project opens a project selection screen where you choose a slot to save the active project to. You can also press **[FUNC] + [SETTINGS]** to access this screen.

#### 15.1.3 MANAGE PROJECTS

Manage Projects launches the PROJECT MANAGER menu. Selecting a project in this menu and pressing the **[RIGHT]** arrow key will bring up a list of commands.

- **CLEAR** Resets the project slot to a clean state.
- **DELETE** Removes the project from the slot.
- **RENAME** Opens a NAMING screen where you can rename the project file.
- **LOAD FROM** Loads the selected project. This will overwrite the active project!
- **SAVE TO** Saves the active project to the selected slot.
- **TOGGLE** Toggles write protection on or off. Write protected projects cannot be overwritten, renamed or erased. A lock symbols in front of the project name shows that the project is write protected.
- **INIT NEW** Initializes an empty file slot with a clean project. This option is only available for empty project slots.

### 15.2 SAMPLES

Here you can manage your samples. Initially, here are three directories FACTORY, INCOMING, and RECORDED. A wide array of preset samples are available in the write protected FACTORY directory. The INCOMING directory is the default destination for samples sent to the Digitakt +Drive storage via the C6 software. RECORDED will contain the samples you create when you sample with the Digitakt.



Use the [ARROW] keys to highlight a directory, and then press [YES] to open it. To exit a directory and back one step up in the directory hierarchy, select the item labeled “..” at the very top of the screen and press [YES]. Do this repeatedly to return to the top of the directory hierarchy. You can also press [FUNC] + [RIGHT] to open a directory and [FUNC] + [LEFT] to exit a directory. To distinguish directories from samples, all directories, including the directory exit row, “..”, are labeled with a (D) at the very end of the row. When browsing a directory in the +Drive, a sample assigned to one of the 127 sample slots of the active project will have its slot number shown as seen below.

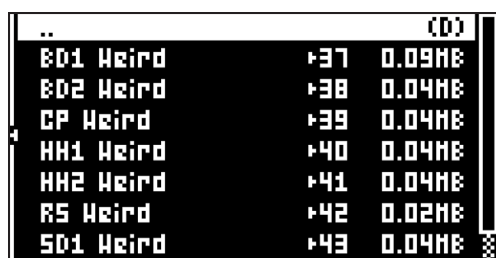

### 15.2.1 LOADING A SAMPLE

You can load one or several samples to the RAM memory of the active project.

1. Press [SETTINGS], and then open the SAMPLES menu.
2. Open the FACTORY directory, and then navigate to the samples you want to load.
3. Highlight the samples, and then press [YES] to select them. Any sample can be previewed (played back by the voice of the active track), just highlight it and then press [FUNC] + [YES]. Approximately, ten seconds of the sample can be previewed.
4. Press the [RIGHT] arrow key. A menu will appear on the right side of the screen.



5. Select LOAD TO PROJ and press [YES].

The samples you selected (ticked) will now appear in the first available empty slots out of the 127 sample slots of the active project. To view the samples currently in the RAM memory of the active project, press the [LEFT] arrow key twice. This will bring up the left side menu.

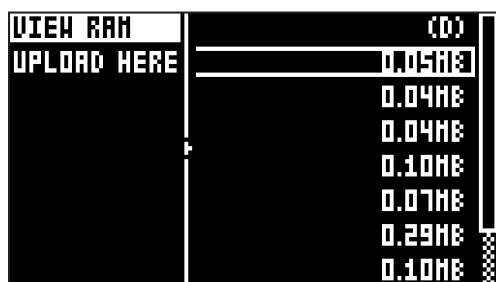



Select VIEW RAM and press [YES]. A list appears that shows all 127 sample slots.

|               |        |
|---------------|--------|
| 004:09 Digit  | 0.19MB |
| 005:0H Digit  | 0.05MB |
| 006:HT Digit  | 0.05MB |
| 007:0H Digit  | 0.06MB |
| 008:50 Digit  | 0.04MB |
| 009:001 Fella | 0.10MB |
| 010:HH2 Fella | 0.13MB |
| 011:0H Fella  | 0.09MB |

On this screen, the 127 samples may be unloaded individually or collectively to empty the slots.

### 15.2.2 UNLOADING A SAMPLE

You can unload one or several samples from the RAM memory of the active project.

1. Scroll the list using the [ARROW] keys [UP]/[DOWN] or the *LEVEL* knob.
2. Press [YES] to tick individual samples, or bring up the right-hand menu by pressing [RIGHT] and choose SELECT ALL.
3. On the right-hand menu, select UNLOAD to empty the slots of the ticked samples.

|               |              |
|---------------|--------------|
| 002:08 Digit  | SELECT ALL   |
| ✓003:0H Digit | DESELECT ALL |
| 004:09 Digit  | UNLOAD       |
| ✓005:0H Digit |              |
| ✓006:HT Digit |              |
| ✓007:0H Digit |              |
| ✓008:50 Digit |              |
| 009:001 Fella |              |

### 15.2.3 REPLACING A SAMPLE

You can replace one or several samples in the RAM memory of the active project.

1. Highlight the slot containing the sample you wish to replace, and then press [RIGHT] to open the right-hand menu and select REPLACE.
2. Browse the directories of the +Drive, locate the desired sample and press [YES] to place it in the previously highlighted sample slot.

If you wish to go back to browsing the +Drive storage directories, press [LEFT] twice and select VIEW +DRIVE.

You can also replace a sample in the RAM memory by replacing it directly in its audio track.

1. Press [TRK] + [TRIG 1-8] to select the audio track that contains the sample you wish to replace.
2. Press [FUNC] + [SRC] to open the RAM memory sample slot list. The sample assigned to the track is highlighted.
3. Press [FUNC] + [YES]. to open the +Drive library
4. Navigate to the sample you want to use, and then press [YES].

You can preview a sample in the +Drive library by highlighting it and pressing [FUNC] + [YES].

### 15.2.4 RENAMING A SAMPLE

You can also rename a sample.

1. Navigate to the directory that contains samples you want to rename.
2. Highlight the sample you want to rename, and then press [YES] to select it.
3. Press the [RIGHT] arrow key. A menu will appear on the right side of the screen.
4. Select RENAME and press [YES].
5. Use the NAMING screen to rename the sample and then press [YES].

### 15.2.5 MOVING A SAMPLE

You can move one or several samples from one directory to another.

1. Navigate to the directory that contains samples you want to move.
2. Highlight the samples you want to move, and then press [YES] to select them.
3. Press the [RIGHT] arrow key. A menu will appear on the right side of the screen.



4. Select SEL FOR MOVE and press [YES].
5. Press [YES], and then navigate to the directory to where you want to move the samples.
6. Press the [LEFT] arrow key, and then highlight MOVE HERE.
7. Press [YES] to move the samples.

### 15.2.6 TRANSFERRING SAMPLES FROM A COMPUTER TO DIGITAKT

1. Connect Digitakt to the computer via USB.
2. Open the Elektron Transfer utility software on your computer.
3. Select the USB MIDI port(s) for your Digitakt on the Transfer start screen.
4. Drag and drop the samples to the Elektron Transfer main window. The samples will automatically be transferred to a default directory (if no other is set) "transfers-yymmdd" that is created in the +Drive storage of the Digitakt. Elektron Transfer automatically converts all audio files to 16 bit, 48 kHz, mono audio files, the Digitakt native audio format.

The time of the transfer depends on the size of the samples. During the transfer, a progress bar on the screen will show how much of the sample has been received, provided that you have the destination directory open on the Digitakt.

To use the samples, they need to be loaded to the active project. For more information, please see "15.2.1 LOADING A SAMPLE" on page 56.

The Digitakt still supports receiving of samples via MIDI Sample Dump Standard (SDS) and Extended SDS. The Elektron C6 software supports this transfer protocol. You need to enable SDS Handshake in order to secure the transmission over fast interfaces like USB MIDI. You also have to enable the transmission of the Extended SDS header if you want the sample name to be sent to the Digitakt (if not, the samples will simply be named 1, 2, 3 ... and so on in the destination directory of the Digitakt).

### 15.2.7 CREATING A NEW DESTINATION DIRECTORY

This procedure is only for when you use the Elektron C6 software transfer tool. If you use Elektron Transfer you can create a new destination directory in the Digitakt directly from Elektron Transfer.

On the main screen, press [ARROW] key [RIGHT] to access the right side menu. Select CREATE DIR to create a new directory by pressing [YES]. A naming screen will appear. Give your new destination directory an appropriate name. Press [YES] to open the new directory. In the initially empty directory, press [ARROW] key [LEFT] to open the left side menu. Highlight UPLOAD HERE and press [YES].

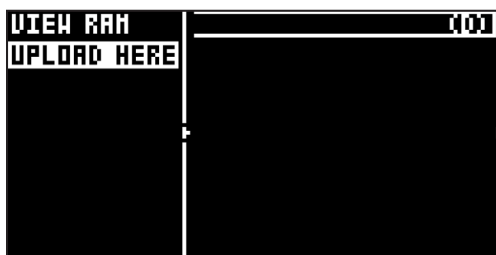

Samples sent from a computer will be written into the new destination directory. Note that any new or existing directory can be set to be the destination directory in a similar manner, accessing the left side menu, except for the FACTORY directory which is write-protected. A directory can be deleted or re-named by highlighting it, accessing the right-hand menu and selecting DELETE DIR or RENAME.



- Make sure you have the latest version of the Elektron Transfer software installed on your computer to efficiently and reliably transfer samples to the Digitakt +Drive storage. The free Elektron Transfer software can be downloaded from the Elektron website.
- Please note that the Digitakt will not appear as an icon on your computer desktop. Use Elektron Transfer or the Elektron C6 for all transfers.
- If MIDI+USB is selected in the INPUT FROM and/or OUTPUT TO settings on the MIDI PORT CONFIG menu (see below), MIDI data transfers will limit the USB speed. When sending or receiving large chunks of data, make sure you use the USB setting.
- Sequencer playback stops when you transfer files to the Digitakt.

### 15.3 MIDI CONFIG

In this menu, various sub-menus dealing with the MIDI functionality of Digitakt are found.



#### 15.3.1 SYNC

Controls how Digitakt receives and sends MIDI clock and transport commands. Change settings by using the [LEFT]/[RIGHT] arrow keys or the [YES] key.

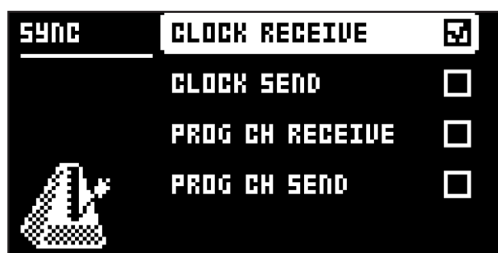

**CLOCK RECEIVE** will, when active, make Digitakt respond to MIDI clock sent from external devices.

**CLOCK SEND** will, when active, make Digitakt transmit MIDI clock.

**PRG CH RECEIVE** will, when active, make Digitakt respond to incoming program change messages, which is useful when wanting to select patterns externally. The MIDI channel that will listen to incoming program change messages is set in the MIDI CHANNELS menu. For more information, please see “15.3.3 CHANNELS” on page 60.

**PRG CH SEND** will, when active, send program change messages when patterns are changed. The MIDI channel that will send program change messages is set in the MIDI CHANNELS menu. For more information, please see “15.3.3 CHANNELS” on page 60.

#### 15.3.2 PORT CONFIG

Here you find the MIDI port related settings. Change settings by using the [LEFT]/[RIGHT] arrow keys.

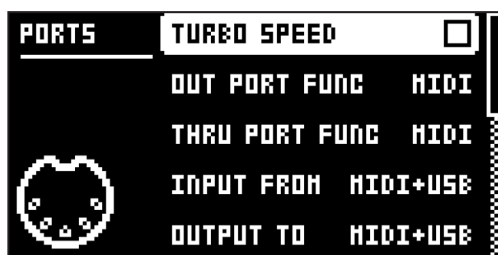

**TURBO SPEED** press [YES] to start the turbo speed negotiation. Speed is chosen automatically. Please note that you must use a MIDI interface that supports the Turbo-MIDI protocol.

**OUT PORT FUNCTIONALITY** selects what type of signal the MIDI OUT port will send.

- **MIDI** makes it possible for the port to send out MIDI data.
- **DIN 24** will make the port send DIN 24 sync pulses. No MIDI data is transferred over the port when this option is selected.
- **DIN 48** will make the port send DIN 48 sync pulses. No MIDI data is transferred over the port when this option is selected.

**THRU PORT FUNCTIONALITY** selects what type of signal the MIDI THRU port will send. The settings are the same as for OUT PORT FUNCTIONALITY.

**INPUT FROM** selects the source Digitakt will receive MIDI data from.

- **DISABLED** will make Digitakt disregard any incoming MIDI data.
- **MIDI** will make Digitakt listen only to MIDI data sent to the MIDI IN port.
- **USB** will make Digitakt listen only to MIDI data sent to the USB port.
- **MIDI+USB** will make Digitakt listen to MIDI data sent to both the MIDI IN and USB ports.

**OUTPUT TO** selects the destination to which Digitakt will send MIDI data.

- **DISABLED** will stop Digitakt from sending out any MIDI data.
- **MIDI** will make Digitakt send MIDI data to the MIDI OUT port only.
- **USB** will make Digitakt send MIDI data to the USB port only.
- **MIDI+USB** will make Digitakt send MIDI data to both the MIDI OUT and USB ports.



If **MIDI+USB** is selected in the **INPUT FROM** and/or **OUTPUT TO** settings, MIDI data will limit the USB speed. When sending or receiving large chunks of data, make sure you only use the USB setting.

**OUTPUT CH** selects whether the knobs will send data on the auto channel or the track channel.

**PARAM OUTPUT** selects what type of MIDI messages the **DATA ENTRY** knobs will send. For information about which CC/NRPN parameters that will be sent, please see “APPENDIX A: MIDI” on page 70.

- **NRPN** will make the knobs send out NRPN MIDI messages.
- **CC** will make the knobs send out CC MIDI messages.

**ENCODER DEST** controls whether the **DATA ENTRY** and **LEVEL/DATA** knobs sends MIDI data or not. When set to INT, the knobs only affects the Digitakt and no MIDI data is sent. When set to INT + EXT, the knobs affects the Digitakt and also sends MIDI data to external devices.

**TRIG KEY DEST** controls whether the **[TRIG]** keys sends MIDI data or not. When set to INT, the **[TRIG]** keys only affects the Digitakt and no MIDI data is sent. When set to INT + EXT, the **[TRIG]** keys affects the Digitakt, and also sends MIDI data to external devices. When set to EXT, the **[TRIG]** keys do not affect the Digitakt but MIDI data is sent externally.

**MUTE DEST** controls whether activating/deactivating mutes will send MIDI data or not. When set to INT, mute only affects the Digitakt and no MIDI data is sent. When set to INT + EXT, mute affects the Digitakt and also send MIDI data to external devices. When set to EXT, mute sends MIDI data externally, but do not affect the Digitakt.

**RECEIVE NOTES** will, when active, make it possible to play Digitakt using an external MIDI keyboard.

**RECEIVE CC/NRPN** will, when active make it possible to control Digitakt parameters from an external MIDI device sending CC/NRPN data.

### 15.3.3 CHANNELS

This menu handles the MIDI channel configuration.



**TRACK 1–8** selects the dedicated MIDI channel that is used to receive or send (by turning the knobs)

parameter data to or from a specific audio track. If configured as OFF, parameter data are neither received nor sent via MIDI.

**TRACK A-H** selects the dedicated MIDI channel that is used to receive or send (by turning the knobs) parameter data to or from a specific MIDI track. If configured as OFF, parameter data are neither received nor sent via MIDI.



- The sequencer data is always sent on the MIDI channel specified by the **CHAN** parameter on the **SRC PARAMETER** page.
- On **TRACK A-H** you can only control the parameters on the **TRIG (NOT1, VEL, LEN, LFO.T)** and **LFO (all) PARAMETER** pages.

**FX CONTROL CH** selects the dedicated MIDI channel that is associated with the parameters on the **DELAY** and **REVERB** parameter pages, both for input and output. If configured as OFF, parameter data are neither sent nor received via MIDI.

**AUTO CHANNEL** selects the MIDI channel that will give access to the currently active track. If an external MIDI keyboard connected to Digitakt sends MIDI data on this channel, the keyboard will control the active track. This is useful when for example quickly changing between the active audio tracks to play different Sounds. The Digitakt also uses the **AUTO** channel to record to the MIDI tracks from external MIDI controllers.

**PROGRAM CHG IN CH** selects the MIDI channel that will listen for incoming program change messages. An **AUTO** setting will use the **AUTO** channel. Enable Digitakt to respond to program change messages in the **MIDI SYNC** menu. For more information, please see “15.3.1 SYNC” on page 59.

**PROGRAM CHG OUT CH** selects the MIDI channel that will send program change messages when changing patterns. An **AUTO** setting will use the **AUTO** channel. Enable Digitakt to send program change messages in the **MIDI SYNC**. For more information, please see “15.3.1 SYNC” on page 59.

## 15.4 SYSEX DUMP

In the **SYSEX DUMP** menu, project, pattern, and Sound data can be sent and received. Select a menu option using **[UP]/[DOWN]** or the **TRACK LEVEL** knob. Press **[YES]** to open the highlighted menu selection.



When receiving or sending SysEx data, the MIDI ports or the USB port of the Digitakt should be connected to the external sending/receiving device.

If the Digitakt is sending or receiving SysEx data through the MIDI ports, use the Elektron TM-1 USB MIDI interface for up to 10x transfer speeds.

If the external device is a computer, we recommend using our free SysEx utility C6, which can be downloaded from the Elektron website.



Please note that Sysex dump only sends and receives project, pattern and Sound data. It does NOT send or receive the Sounds samples.

### 15.4.1 SYSEX SEND

Here projects, patterns, and Sounds can be sent to an external device via the MIDI OUT port or the USB port of the Digitakt.



The column to the left selects what will be backed up. Select the column using the [LEFT] arrow key. Use the [UP]/[DOWN] keys or the **TRACK LEVEL** knob to navigate in the column. The SysEx data send alternatives located in the column to the right will change depending on the selection made in the left column. Press the [RIGHT] arrow key to access this column. Use the [UP]/[DOWN] keys or the **TRACK LEVEL** knob to select what will be sent. Press [YES] to initiate the SysEx send procedure.

**PROJECT** will send the active project (settings, patterns, Sounds in the Sound Pool).

**PATTERN** will send the selected pattern.



- Backing up your data regularly is important!
- Before initiating a SysEx send, first, make sure the receiving device is listening for data to be sent.

### 15.4.2 SYSEX RECEIVE

Here projects, patterns, and Sounds can be received from an external device via the MIDI IN port or the USB port of the Digitakt.



The column to the left selects what will be received. Select the column using the [LEFT] arrow key. Use the [UP]/[DOWN] keys or the **TRACK LEVEL** knob to navigate in the column. The SysEx data receive alternatives located in the column to the right will change depending on the selection made in the left column. Press the [RIGHT] arrow key to access this column. Use the [UP]/[DOWN] keys or the **TRACK LEVEL** knob to select what will be received. Press [YES] to initiate the SysEx receive procedure. The Digitakt starts listening to incoming data. Press [NO] to stop listening.

**PATTERN** will store a received pattern to the selected pattern slot.

**SOUNDS** will store a received Sound to the selected slot of the +Drive Sound library. The option ANYWHERE will place the Sound in the first free slot available. To the right of the bank indication, the amount of free slots can be seen.

## 15.5 SYSTEM

The System menu contains OS UPGRADE, FORMAT +DRIVE, and STORAGE options for the Digitakt.



### 15.5.1 OS UPGRADE

This menu option is used when you want to upgrade the Digitakt OS. To send the OS syx file, use our free Elektron Transfer software. The OS syx file and Elektron Transfer can be downloaded from the Elektron website.

For the transfer to be possible, the device sending the OS syx file must be connected to either the MIDI IN or USB port of Digitakt.

Please note that the Digitakt will not appear as an icon on your computer desktop.

1. Press [YES] to make Digitakt start listening for incoming OS SysEx data. If you wish to cancel the waiting state, press [NO].



2. Open Elektron Transfer and select Elektron Digitakt for MIDI Input device as well as MIDI Output device.
3. Drag and drop the syx file to the Elektron Transfer main window to send it to the Digitakt.

A progress bar is visible on the Digitakt screen when receiving the OS. When the process is successfully completed, the OS is updated and the unit reboots.



If the Digitakt is receiving the OS upgrade through the MIDI ports, use the Elektron TM-1 USB MIDI interface for up to 10x transfer speeds.

### 15.5.2 FORMAT +DRIVE

You have the possibility to erase all content of the +Drive. Once you have made your choices using the [LEFT] or [RIGHT] arrow keys and confirmed by pressing [YES], a prompt will appear asking if you want to execute the formatting procedure. Press [YES] to proceed with the formatting.



**PROJECTS+SOUNDS** Erases all projects and Sounds. Tick/untick this box by pressing the [LEFT] or [RIGHT] arrow keys.

**SAMPLES** Erases all samples. Tick/untick this box by pressing the [LEFT] or [RIGHT] arrow keys.

### 15.5.3 STORAGE

Here you get an overview of what is stored in the RAM and the +Drive and how much memory that is available. Other than the number of Projects, Sounds, and Samples, and you also see the amount of sample time used and remaining. On the right, you see the memory usage of the RAM and the +Drive.



### 16. STARTUP MENU

---

To access this menu, hold down the **[FUNC]** key while powering up the Digitakt. From here you can perform a variety of tasks. To choose the different alternatives, press the corresponding **[TRIG]** key.

#### 16.1 TEST MODE

To enter this mode, press the **[TRIG 1]** key.



For testing purposes, a short sound is heard through all outputs of the unit.

If you have any trouble with your Digitakt and suspect it may be due to a hardware problem, perform this self-test. The **[UP]** and **[DOWN]** keys can be used to scroll through the test log. A fully functional device should not report any errors. If it does report an error, please contact Elektron support or the retailer that you bought your Digitakt from.

#### 16.2 EMPTY RESET

To perform this operation, press the **[TRIG 2]** key. All patterns and Sounds will be erased. The data on the +Drive remains intact.

#### 16.3 FACTORY RESET

When performing a factory reset on the Digitakt, it will overwrite and re-initialize the active RAM project (including all pattern and global data). The +Drive project slot 1 will be overwritten and re-initialized with factory preset patterns, Sounds and settings. Sound bank A will be overwritten with the factory Sounds.

If you wish to keep the active project, remember to save it to a +Drive project slot higher than 1 before you perform a factory reset. To perform a factory reset, press the **[TRIG 3]** key.

#### 16.4 OS UPGRADE

Initiate the OS upgrade by pressing the **[TRIG 4]** key. Digitakt will enter a waiting stage, listening for incoming OS data, and "READY TO RECEIVE" will be shown on the screen. For the transfer to be possible, the device sending the OS syx file must be connected to the MIDI IN port of Digitakt. To send the OS syx file, use our free SysEx utility software C6. The OS syx file and the C6 software can be downloaded from the Elektron website.



- You cannot use the Elektron Transfer software to transfer OS syx files when you are in the STARTUP menu.
- USB MIDI transfer is not possible when you want to upgrade the OS from the STARTUP menu.

On your computer, download the OS syx file, open the C6 software. Click CONFIGURE and select Digitakt for MIDI In as well as MIDI Out. Drag the syx file to the C6 main window, then highlight it by clicking on it with the mouse pointer. Click the "send" button in the top left corner of the C6 window.

As the Digitakt receives the OS, a progress bar will show how much of the OS has been received. When the transfer is finished the message "UPGRADING... DO NOT TURN OFF" appears. Please note that the upgrade takes a little while. The device will restart when the upgrade process is finished.



- When you send the OS syx file, use our free Elektron C6 software. You can download it from the Elektron website.
- If the Digitakt receives the OS upgrade through the MIDI ports, you can use the Elektron TM-1 USB MIDI interface for up to 10x transfer speeds.

#### 16.5 EXIT

Press the **[TRIG 5]** key to exit the STARTUP menu.



## 17. SETUP EXAMPLES

The Digitakt likes to play with other machines. Whether it uses its ability to sync and play with legacy machines, samples from your smart phone or controls other synthesizers: Digitakt gets along with other gear.

### 17.1 DIGITAKT WITH A MONOPHONIC BASS MACHINE

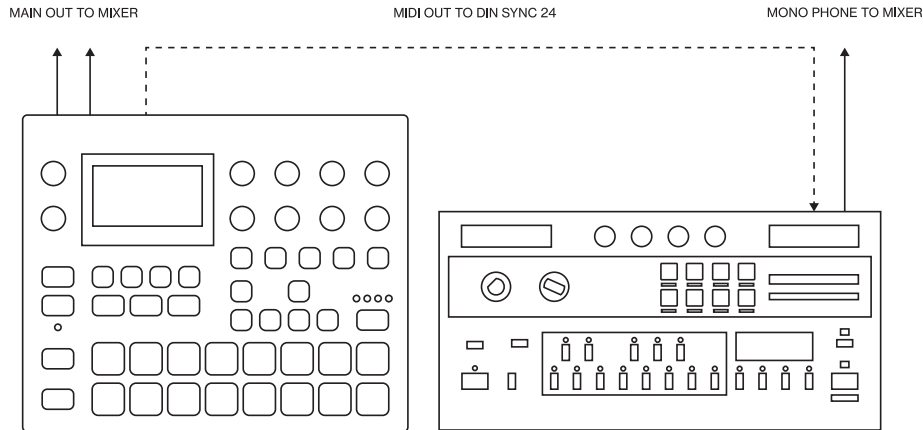

The DIN sync capabilities of the Digitakt allows you to use gear from yesteryear.

In this example, a legacy monophonic bass machine is used alongside the Digitakt. The Digitakt can stop, start and control the tempo of the bass machine.

1. Prepare a bassline pattern on the bass machine.
2. Connect the output of the bass machine to the mixer using a Mono jack 6.3 mm male cable.
3. Connect the Digitakt audio outputs to the mixer using 2 x Mono or Stereo jack 6.3 mm male cables.
4. Use a DIN connector cable to connect the MIDI OUT of the Digitakt to the SYNC IN of the bass machine.
5. On the Digitakt, press **[SETTINGS]**, and then navigate to MIDI CONFIG > PORT CONFIG and set **OUT PORT CONFIG** to DIN24.



6. Press **[PLAY]** on the Digitakt.

### 17.2 SAMPLING FROM A SMART PHONE

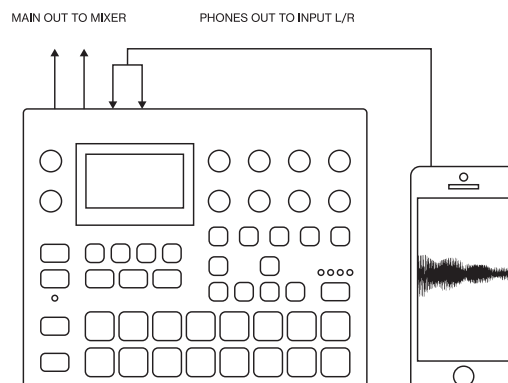

Digitakt can sample sounds from many different sound sources. In this example, we want to sample sound from a smart phone.

1. Use a 2 x Mono jack 6.3 mm male > Mini jack 3.5 mm stereo male cable to connect your smart phone to the Digitakt's INPUT L+R jacks.
2. Press **[SAMPLING]** to access the SAMPLING menu and then use **DATA ENTRY** knob **G** to set **SOURCE** to EXT L+R. The stereo signal is summed to mono in the Digitakt.



3. You are now ready to start sampling audio from your smart phone. For more information about the sampling process, please see "14. SAMPLING" on page 52.

### 17.3 CONTROLLING A SYNTHESIZER USING THE MIDI TRACKS

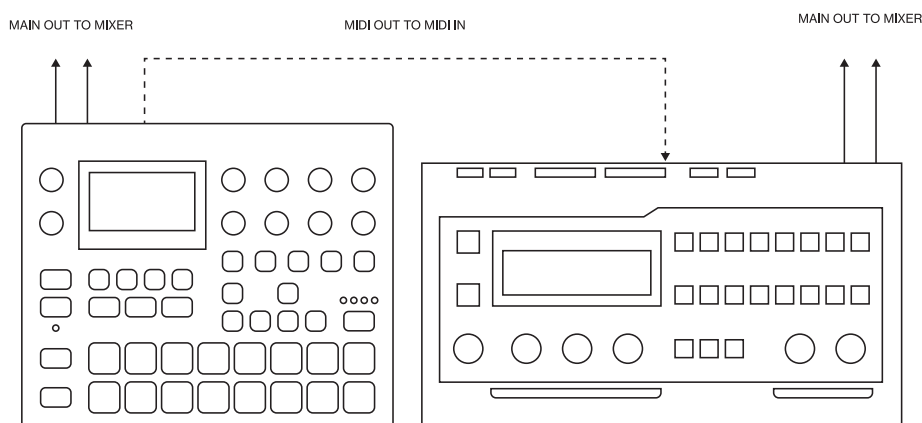

Digitakt has extensive capabilities to use its sequencer's MIDI tracks to control other MIDI-equipped synthesizers.

1. Use a standard MIDI cable to connect the Digitakt MIDI OUT jack with the synthesizer's MIDI IN jack.
2. On the Digitakt, press **[SETTINGS]**, and then navigate to MIDI CONFIG > PORT CONFIG and set **OUT PORT FUNC** to MIDI.
3. In the same menu set **OUTPUT** to MIDI.



4. On the main screen, press **[TRK]** + **[TRIG 9-16]** to select a MIDI track.
5. Press **[SRC]** and use the **CHAN** parameter to select a MIDI channel that the track will output its data to.
6. Make sure to set your synthesizer to receive MIDI input in a way that corresponds to the settings you made in the Digitakt.

You are now ready to use the Digitakt sequencer to control your synthesizer. For more information about using the Digitakt sequencer, please see "10. THE SEQUENCER" on page 28.

---

## 18. USEFUL KEY COMBINATIONS (QUICK KEYS)

---

Use the key combinations below to quickly perform certain tasks.

### GENERAL

[FUNC] + [REC] performs a copy command. Action depends on the currently active page or mode.

[FUNC] + [PLAY] performs a clear command. Action depends on the currently active page or mode.

[FUNC] + [STOP] performs a paste command. Action depends on the content that was copied.

### TRACK/PATTERN/BANK SELECT

[TRK] + [TRIG 1-8] keys to select an audio track.

[TRK] + [TRIG 9-16] keys to select a MIDI track.

[PTN] + [TRIG 1-16] keys to select a pattern.

[BANK] + [TRIG 9-16] keys to select a bank.

### NAMING

[FUNC] + [ARROW] (on the NAMING screen) to choose a letter.

[FUNC] + [NO] (on the NAMING screen) to erase a letter.

### SAVING AND RELOADING

[FUNC] + [SETTINGS] saves the active Project.

[FUNC] + [YES] temporary saves the active Pattern.

[FUNC] + [NO] temporary reloads the active Pattern.

### NAVIGATING

[FUNC] + [RIGHT] (In the SAMPLES menu) opens a directory.

[FUNC] + [LEFT] (In the SAMPLES menu) exits a directory and backs one step up in the directory hierarchy.

### MENU ACCESS

[FUNC] + [PATTERN MENU] opens the IMPORT/EXPORT menu.

[FUNC] + [TRIG SETTINGS] opens the QUANTIZE menu.

[FUNC] + [FLTR] opens the DELAY menu.

[FUNC] + [AMP] opens the REVERB menu.

[FUNC] + [LFO] opens the MASTER menu.

[FUNC] + [PTN] opens the METRONOME menu.

[FUNC] + [PAGE] opens the pattern/track SCALE menu.

### SEQUENCER SETTINGS

[FUNC] + [TEMPO] to tap tempo.

[FUNC] + [LEFT/RIGHT] to nudge tempo (when sequencer is playing).

[FUNC] + [LEFT/RIGHT] moves all trigs a whole step, left or right (when in GRID RECORDING mode).

[TRIG] key (hold) + [UP/DOWN], opens the RETRIG menu and turns retrigger on and sets the retrigger RATE for the trig (when in GRID RECORDING mode).

[TRIG] key (hold) + [LEFT/RIGHT], opens the MICRO TIMING menu and sets the micro timing for the trig (when in GRID RECORDING mode).

### SEQUENCER RECORDING

[RECORD] + [PLAY] starts LIVE RECORDING.

[RECORD] + double-tap [PLAY] activates/deactivates QUANTIZE LIVE RECORDING.

[NO] + [TRIG] key during LIVE RECORDING clears the trigs from a sequencer track.

[FUNC] + [PTN] (long press) toggles the metronome on/off.

---

### MUTES

[FUNC] + [TRIG] keys mutes/unmutes one or several tracks.

### MODES

[FUNC] + [BANK] enters GLOBAL MUTE mode.

[FUNC] + double-press [BANK] enters PATTERN MUTE mode.

[FUNC] + [TRK] enters CHROMATIC mode.

[YES] + [PAGE] activates FILL mode for one pattern cycle.

Press and hold [PAGE] to activate FILL Mode for as long as [PAGE] is held.

Press and hold [PAGE] + [YES], and then release [PAGE] before you release [YES] to latch FILL mode.

Press [PAGE] again to unlatch FILL mode.

### CLEAR TRACK/CLEAR PATTERN

[FUNC] + [PLAY] (while in GRID RECORDING mode) clears active track.

[FUNC] + [PLAY] (while in no mode or LIVE RECORDING mode) clears pattern.

### RESET PARAMETERS

Press *DATA ENTRY* knob + [NO] to reset the parameter to the default value.

[PARAMETER] key + [PLAY] to reset all the parameters in the selected parameter page to default values.

### SAMPLE SELECT

[FUNC] + [SRC] accesses the SAMPLE SELECT parameter.

### DIRECT SAMPLING

[SAMPLING] + [YES] arms the sampler.

[FUNC] + [SAMPLING] starts sampling.

[FUNC] + [SAMPLING] stop sampling (after it has been started).

[SAMPLING] + [NO] cancels at any stage in the Direct Sampling process.

## 19. TECHNICAL INFORMATION

### ELECTRICAL SPECIFICATIONS

#### Impedance balanced audio outputs

Main outputs level: +22 dBu peak  
Output impedance: 440  $\Omega$  unbalanced  
Digital S/N ratio: 108 dB (20–20.000 Hz)

#### Headphones output

Headphones out level: +22 dBu peak  
Output impedance: 55  $\Omega$

#### Audio inputs

Input level: +19 dBu peak  
Audio input impedance: 11 k $\Omega$   
Digital S/N ratio: 110 dB (20–20.000 Hz)

Unit power consumption: 7 W typical  
Compatible Elektron power supply: PSU-3b

### HARDWARE

128 × 64 pixel OLED screen  
MIDI In/Out/Thru with DIN Sync out  
2 × 1/4" impedance balanced audio out jacks  
2 × 1/4" audio in jacks  
1 × 1/4" stereo headphone jack  
48 kHz, 24-bit D/A and A/D converters  
Electrically isolated hi-speed USB 2.0 port  
Power inlet: Center positive 5.5 × 2.5 mm barrel jack,  
12 V DC, 1 A

### PHYSICAL SPECIFICATIONS

Sturdy steel casing  
Dimensions: W 215 × D 176 × H 63 mm  
(8.5" × 6.9" × 2.5") (including knobs and feet)  
Weight: approximately 1.45 kg (3.2 lbs)  
100 × 100 mm VESA mounting holes. Use M4 screws  
with a max length of 7 mm.  
Maximum recommended ambient operating  
temperature: +40 °C (+104 °F)

## 20. CREDITS AND CONTACT INFORMATION

### CREDITS

#### PRODUCT DESIGN AND DEVELOPMENT

Oscar Albinsson  
Ali Alper Çakır  
Oscar Dragén  
Magnus Forsell  
Anders Gärder  
Fabian Hundertmark  
Christer Lindström  
Jimmy Myhrman  
Jon Mårtensson  
David Revelj  
Mattias Rickardsson  
Martin Sigby

#### ADDITIONAL DESIGN

Johan Damerou  
Ufuk Demir  
Thomas Ekelund  
Simon Mattisson  
Olle Petersson  
Cenk Sayinli

#### DOCUMENTATION

Erik Ångman

### CONTACT INFORMATION

#### ELEKTRON WEBSITE

<http://www.elektron.se>

#### OFFICE ADDRESS

Elektron Music Machines MAV AB  
Sockerbruket 9  
SE-414 51 Gothenburg  
Sweden

#### TELEPHONE

+46 (0)31 743 744 0

## APPENDIX A: MIDI

This appendix lists the CC and NRPN specification for the Digitakt.

### A.1 TRACK PARAMETERS

| TRACK       |        |        |          |          |
|-------------|--------|--------|----------|----------|
| Parameter   | CC MSB | CC LSB | NRPN MSB | NRPN LSB |
| Mute        | 94     |        | 1        | 101      |
| Track level | 95     |        | 1        | 100      |

### A.2 TRIG PARAMETERS

| TRIG PARAMETERS |        |        |          |          |
|-----------------|--------|--------|----------|----------|
| Parameter       | CC MSB | CC LSB | NRPN MSB | NRPN LSB |
| Note            | 3      |        | 3        | 0        |
| Velocity        | 4      |        | 3        | 1        |
| Length          | 5      |        | 3        | 2        |
| Filter Trig     | 13     |        |          |          |
| LFO Trig        | 14     |        |          |          |

### A.3 SOURCE PARAMETERS

| SOURCE        |        |        |          |          |
|---------------|--------|--------|----------|----------|
| Parameter     | CC MSB | CC LSB | NRPN MSB | NRPN LSB |
| Tune          | 16     |        | 1        | 0        |
| Play mode     | 17     |        | 1        | 1        |
| Bit reduction | 18     |        | 1        | 2        |
| Sample slot   | 19     |        | 1        | 3        |
| Start         | 20     |        | 1        | 4        |
| Length        | 21     |        | 1        | 5        |
| Loop position | 22     |        | 1        | 6        |
| Sample level  | 23     |        | 1        | 7        |

### A.4 FILTER PARAMETERS

| FILTER           |        |        |          |          |
|------------------|--------|--------|----------|----------|
| Parameter        | CC MSB | CC LSB | NRPN MSB | NRPN LSB |
| Filter Frequency | 74     |        | 1        | 20       |
| Resonance        | 75     |        | 1        | 21       |
| Filter Type      | 76     |        | 1        | 22       |
| Attack Time      | 70     |        | 1        | 16       |
| Decay Time       | 71     |        | 1        | 17       |
| Sustain Level    | 72     |        | 1        | 18       |
| Release Time     | 73     |        | 1        | 19       |
| Env. Depth       | 77     |        | 1        | 23       |

### A.5 AMP PARAMETERS

| AMP         |        |        |          |          |
|-------------|--------|--------|----------|----------|
| Parameter   | CC MSB | CC LSB | NRPN MSB | NRPN LSB |
| Attack Time | 78     |        | 1        | 24       |
| Hold Time   | 79     |        | 1        | 25       |

| AMP         |        |        |          |          |
|-------------|--------|--------|----------|----------|
| Parameter   | CC MSB | CC LSB | NRPN MSB | NRPN LSB |
| Decay Time  | 80     |        | 1        | 26       |
| Overdrive   | 81     |        | 1        | 27       |
| Delay Send  | 82     |        | 1        | 28       |
| Reverb Send | 83     |        | 1        | 29       |
| Pan         | 10     |        | 1        | 30       |
| Volume      | 7      |        | 1        | 31       |

## A.6 LFO PARAMETERS

Note that the LFO depth is a high-resolution parameter, with CC LSB value.

| LFO         |        |        |          |          |
|-------------|--------|--------|----------|----------|
| Parameter   | CC MSB | CC LSB | NRPN MSB | NRPN LSB |
| Speed       | 102    |        | 1        | 32       |
| Multiplier  | 103    |        | 1        | 33       |
| Fade In/Out | 104    |        | 1        | 34       |
| Destination | 105    |        | 1        | 35       |
| Waveform    | 106    |        | 1        | 36       |
| Start Phase | 107    |        | 1        | 37       |
| Trig Mode   | 108    |        | 1        | 38       |
| Depth       | 109    | 118    | 1        | 39       |

## A.7 FX PARAMETERS

| DELAY           |        |        |          |          |
|-----------------|--------|--------|----------|----------|
| Parameter       | CC MSB | CC LSB | NRPN MSB | NRPN LSB |
| Delay Time      | 85     |        | 2        | 0        |
| Pingpong        | 86     |        | 2        | 1        |
| Stereo Width    | 87     |        | 2        | 2        |
| Feedback        | 88     |        | 2        | 3        |
| Highpass Filter | 89     |        | 2        | 4        |
| Lowpass Filter  | 90     |        | 2        | 5        |
| Reverb Send     | 91     |        | 2        | 6        |
| Mix Volume      | 92     |        | 2        | 7        |

| REVERB          |        |        |          |          |
|-----------------|--------|--------|----------|----------|
| Parameter       | CC MSB | CC LSB | NRPN MSB | NRPN LSB |
| Predelay        | 24     |        | 2        | 8        |
| Decay Time      | 25     |        | 2        | 9        |
| Shelving Freq   | 26     |        | 2        | 10       |
| Shelving Gain   | 27     |        | 2        | 11       |
| Highpass Filter | 28     |        | 2        | 12       |
| Lowpass Filter  | 29     |        | 2        | 13       |
| Mix Volume      | 31     |        | 2        | 15       |

---

**INDEX**

---

**+DRIVE 14, 23****A****AUDIO TRACK PARAMETERS 38**

- Amp 41
- Filter 40
- LFO 42
- Source 38
- Trig 38

**B****BIT REDUCTION 39****C****CHAINS 37****CHROMATIC MODE 21****CONDITIONAL LOCKS 34, 35****CONNECTORS 12****COPY, PASTE AND CLEAR 36****CREDITS AND CONTACT INFORMATION 69****D****DATA STRUCTURE 14**

- Patterns 14
- Project 14
- Samples 14
- Sounds 14

**DELAY 49****DIRECT SAMPLING 53****E****EARLY STARTUP MENU 64****F****FACTORY RESET 64****FILL MODE 35****FILTER 40****FX PARAMETERS 49**

- Delay 49
- Reverb 50

**K****KEY COMBINATIONS 67****KITS 23****L****LFO 42, 47****M****MICRO TIMING 30****MIDI CC & NRPN 70****MIDI CONFIG 59****MIDI TRACK PARAMETERS 45**

- Amp (CC select) 46
- Filter (CC value) 46

LFO 47

Source 45

Trig 45

**MUTE MODE 22****N****NAMING SCREEN 17****O****OS UPGRADE 62****OVERBRIDGE 18****OVERDRIVE 42****P****PANEL LAYOUT 10****PARAMETER LOCKS 34****PATTERNS**

- Grid recording mode 29
- Live recording mode 29
- Parameter locks 34
- Pattern control 28
- Selecting a pattern 28
- Tempo 28
- Trig Types 29

**PATTERNS, KITS, SOUNDS, AND SAMPLES 23**

- Assigning a sample 26
- Editing a sound 26
- Playing a sound 26
- Sound Browser 24
- Sound Manager 24

**PROJECT MANAGER 55****PROJECTS 55**

- Load 55
- Project Manager 55
- Save 55
- Write protection 55

**Q****QUANTIZATION 32****QUICK SCROLLING 17****QUICK START 19****R****RECORDING MODES**

- Grid recording mode 29
- Live recording mode 29

**RETRIG MENU 30****REVERB 50****S****SAFETY AND MAINTENANCE 3****SAMPLES 55**

- Create a new destination directory 58
- Loading 56
- Moving 57



---

- Renaming 57
- Replacing 57
- Transferring from computer 58
- Unloading 57

**SAMPLING 52**

- Assigning a sample from +Drive 53
- Direct sampling 53
- Sample playback 53
- Sampling audio 20, 52, 53

**SCALE SETUP**

- Length per pattern mode 33
- Length per track mode 33

**SEQUENCER 28**

- Conditional locks 34, 35
- Editing a pattern 28
- Metronome 32
- Micro timing 30
- Parameter locks 34
- Pattern control 28
- Retrig Menu 30
- Scale Menu 32
- Selecting a pattern 28
- Swing 36
- Trig parameters page 32

**SETTINGS 55**

- MIDI config 59
- Project 55
- Sample management 55
- System 62

**SETUP EXAMPLES 65**

- Controlling a synthesizer using the MIDI tracks 66
- Digitakt with a monophonic bass machine 65
- Sampling from a smart phone 65

**SOUND ARCHITECTURE 13****SOUND BROWSER 24****SOUND LOCKS 34****SOUND MANAGER 24****SOUNDS**

- Audio track parameters 38
- Editing a Sound 26
- Playing a Sound 26

**SWING 36****SYSEX DUMP 61****T****TECHNICAL INFORMATION 69****TEMPORARY SAVE AND RELOAD 36****TRIG PARAMETERS PAGE 32****TRIGS 29**

- Lock trigs 29
- Note trigs 29
- Parameter locks 34
- Sound lock 34

**U****USER INTERFACE 16**

 **elektron**