



# Table Of Contents

<b>Foreword</b> .....	<b>3</b>	<b>Parts and Multis</b> .....	<b>78</b>
<b>Control Features &amp; Connections</b> .....	<b>6</b>	<b>System Configuration</b> .....	<b>85</b>
Front Panel.....	6	<b>Kyra Sound Programming</b> .....	<b>95</b>
Rear Panel Connections.....	7	<b>Troubleshooting</b> .....	<b>125</b>
<b>Specifications</b> .....	<b>8</b>	<b>Kyra USB Interface</b> .....	<b>130</b>
<b>Introduction</b> .....	<b>10</b>	<b>Kyra Firmware Update</b> .....	<b>130</b>
<b>Setup and Connections</b> .....	<b>13</b>	<b>Technical Data</b> .....	<b>135</b>
<b>System Overview</b> .....	<b>18</b>	<b>Glossary</b> .....	<b>136</b>
<b>Basic Controls</b> .....	<b>20</b>	<b>Product Support</b> .....	<b>154</b>
<b>The Control Panel Sections</b> .....	<b>29</b>	<b>MIDI Implementation Chart</b> .....	<b>155</b>
Oscillator Groups.....	33		
Sub Oscillator 1 & 2 Controls.....	39		
Filter Controls.....	45		
Envelope Generator Controls.....	49		
Amplifier Controls.....	53		
LFO Controls.....	54		
Mod Matrix Controls.....	57		
Effects Controls.....	61		
Arpeggiator Controls.....	61		

## Foreword

Thank you for purchasing the Waldorf Kyra. You are the owner of one of the most powerful music synthesizers ever built. We designed Kyra as a tool to craft with, it is highly capable instrument ready and waiting for you to experiment and create new sounds. Kyra comes with over a thousand factory sounds that are ready to use in your productions and performances as well as to provide a great template for your own sound creations. The factory sounds are just the starting point that merely scratch the surface of what the instrument is capable of. Dive in and experiment, your efforts will be rewarded with new and exciting sounds, many of which would be very difficult to create on other instruments. Kyra can cover a very wide range of sounds from acoustic and electric pianos, lush pads and strings as well as a wide range of synthetic sounds.

Kyra is perfect for both performance and studio work. For live performance, Kyra's superior capabilities, reliability, interactivity and fast response make it eminently preferable to software synthesizers. For studio musicians, Kyra offers 8 fully functional and independent multitimbral Parts with the horsepower to back it up relieving your DAW of fickle CPU-intensive plugins. With a generous and transparent voice allocation algorithm it is realistic to

compose for all 8 Parts making Kyra a true composer's workstation. Ultra-fast MIDI processing ensures timing remains tight even with dense multi-part compositions.

Kyra is a true hardware synthesizer. It is not a software application running on generic DSP (digital signal processor) devices but a complete custom-designed FPGA hardware engine built specifically for sound synthesis.

### What to read?

The biggest problem with any manual is to find a way to address the needs of absolute beginners and experts alike. Some people read a manual cover to cover while others don't even touch it. Opting for the latter is a poor choice, especially when the manual describes a Waldorf instrument!

Anyone reading the following manual is in for a lot of fun while learning about and working with the Waldorf Kyra.

Your Waldorf Team.

## Notice

Waldorf Music is not liable for any erroneous information contained in this manual. The contents of this manual may be updated at any time without prior notice and firmware updates may add, remove or change features. We made every effort to ensure the information herein is accurate and that the manual contains no contradictory information. Waldorf Music extends no liabilities regarding this manual other than those required by local law.

This manual or any portion of it may not be reproduced in any form without the manufacturer's written consent.

Please note that all elements of Kyra, its software, user interface design, synthesis, filtering and effects algorithms are proprietary © 2019 Waldorf Music GmbH.

Waldorf Music GmbH, Lilienthalstraße 7, 53424 Remagen, Germany.



## Kyra Development Team

Software + FPGA:	Manuel Caballero
Hardware/Housing:	Manuel Caballero, Frank Schneider
Design:	Axel Hartmann
Manual:	Manuel Caballero, Holger Steinbrink
Sounddesign:	Manuel Caballero, Jürgen Driessen, Sigggi Müller, Luke Terry
Revision:	1.0, August 2019

## We would like to thank

Thomas Brenner, Karsten Dubsch, Willie Eckl, Joachim Flor, Roger Keller, Jonathan Miller, Pierre Nozet, Miroslav Pindus, Oliver Rockstedt, Vladimir Salnikov, Winfried Schuld, Lukas Schütte, Michael von Garnier, Kurt 'Lu' Wangard, Rolf Wöhrmann, Haibin Wu and anyone we have forgotten.

Kyra's wavetables comprise almost the entire set of wavetables from the AKWF Waveforms set, kindly placed into the public domain by Kristoffer Ekstrand / Adventure Kid. The entire AKWF sample set can be downloaded from <https://www.adventurekid.se>

# Control Features & Connections

## Front Panel

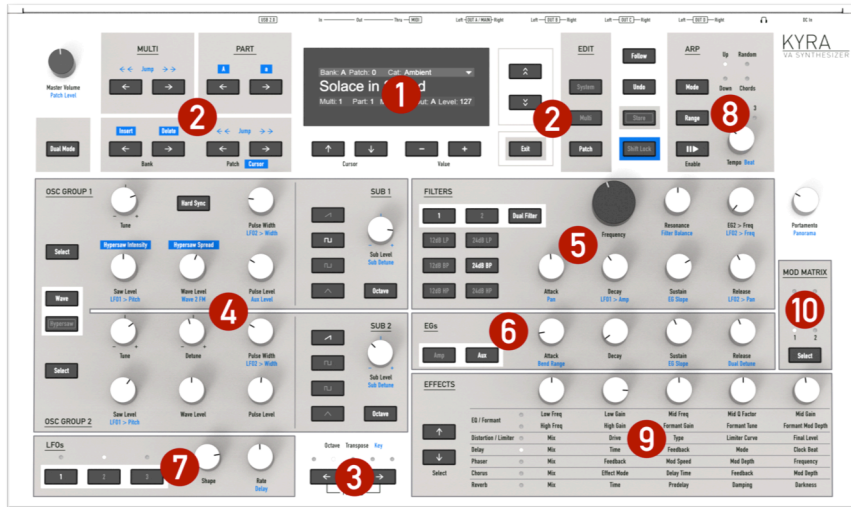

1) OLED Display

4) Oscillator Groups

7) LFO Section

10) Modulation Matrix

2) Patch/Multi Navigation

5) Filters Section

8) Arpeggiator Section

3) Transpose & Power

6) Envelopes Section

9) Effects Section

## Rear Panel Connections



- 1) Power Supply Jack
- 2) Headphones Output
- 3) Audio Line Outputs A-D
- 4) MIDI Thru, MIDI Out, MIDI In
- 5) USB 2.0 Connection
- 6) Kensington® Compatible Lock Recepticle

## Specifications

- **Processing:** 32x oversampled 32-bit hardware sound generation. 96kHz floating point sound processing.
- **Line outputs:** 4 balanced stereo pairs using 32-bit DAC running at 96kHz sample rate.
- **USB audio:** USB Audio Class 2.0 - 8 stereo 24-bit streams at 96kHz with 48kHz downsample mode available. Soundcard mode supporting the return of a single 24-bit stereo audio stream from host DAW.
- **MIDI:** USB 2.0 and DIN (5-pin DIN connector)
- **Display:** High resolution 256x64 pixel graphic OLED
- **Polyphony:** Guaranteed contention-free 128 voice channels. A Dual Mode or Dual Filter Patch uses two voice channels per note played. Up to 32 notes (single or dual) per multitimbral part.
- **Multitimbrality:** 8 independent Parts each with dedicated 9 module multi effects with dedicated audio stream via USB. Each Part can be mixed to one of the four analogue stereo line outputs.
- **Microtuning:** Full key microtuning capability with MIDI Tuning Standard (MTS) support.
- **Oscillators:** Two primary virtually alias-free Oscillator Groups per voice each with sawtooth, pulse, wavetable and noise available simultaneously. Each Oscillator Group also has an independent detunable oscillator with four selectable shapes and two selectable pitches. Real Hard Sync, Ring Modulation and FM (frequency modulation) is available between the Oscillator Groups.
- **Hypersaw:** Six real oscillator hypersaw with adjustable geometric detuning and intensity algorithm. In Dual Mode, the hypersaw has twelve real oscillator sources with an additional adjustable stereo spread.
- **Wavetables:** 4096 18-bit linear PCM single-cycle 32x oversampled wavetables covering a huge range of synthetic and emulated sound sources. Two independent wavetable sources per voice. Hard sync, Ring Modulation and FM is possible on wavetables. Actual wave shape is shown in the wavetable navigator.
- **Filters:** Accurate emulations of classic analogue ladder filters with low pass, band pass and high pass configurations. 2-pole (12dB/octave) and 4-pole (24dB/octave) responses are available for

all three filter types. 128 Filters configurable for single or dual parallel (true stereo) operation.

- **Envelope Generators:** Three fast-response ADSR envelope generators with slope setting. One is assigned to the VCA, another to the filter and the third can be freely assigned. All are available in the Mod Matrix.
- **LFOs:** 3 LFOs with 128 wavetable shapes. Monophonic, polyphonic, random, antiphase and quadrature stereo phase settings. MIDI clock sync source. All LFOs available in the Mod Matrix. FM between LFOs is possible.
- **Modulation Matrix:** 6 channels with up to 3 destinations per channel giving a maximum 18 routings.
- **Effects:** Nine module stereo effects unit per Part with a 3-band shelving EQ, a Formant Filter, 5-mode Distortion module, dual Limiters, stereo Delay module, 6-stage Phaser with dedicated stereo multishape LFO, Chorus/Flanger module supporting comb and doubling effects and a Reverb module. All 72 effects modules can be used simultaneously without affecting polyphony.
- **Arpeggiator:** 128 preset patterns, chord mode and the ability to synchronise to MIDI clock.

- **Patch storage:** 3,328 in total all of which are user programmable. Any Patch can be recalled via MIDI program changes and bank select commands.
- **Support software:** Windows driver, Kyra Firmware Manager for Windows and macOS

# Introduction

## About this Manual

This manual was written to help you to become familiar with the Waldorf Kyra synthesizer. It will also help experienced users discover exciting new features.

To avoid confusion, the terminology in this manual is based on the Kyra parameter names. You will find a glossary at the end of this manual; it explains the various terms used.

We also use a uniform set of symbols to show you topics of particular interest or significance. Important terms are highlighted in bold letters.

## Symbols



Caution – The information that follows this symbol will help you avoid errors, data loss or malfunctions.



Info – Additional Information on a given topic.



Example – Hints for how to get the best results from Kyra and real-world examples to try out.

## Highlighted Control Features and Parameters

All of the Kyra's buttons, controls and parameters are highlighted in **bold** letters throughout the manual.

Examples:

- Press the **System Edit** button.
- Turn the **Filter Frequency** control.

Kyra's different modes and pages are illustrated by a depiction of the display.

## General Safety Guidelines



Please read the following safety tips carefully! They include several precautions you should always observe when dealing with electronic equipment. **Read all of the instructions before operating your device.**

## Recommended Operating Conditions

- Use the device indoors only.
- Never use the device in damp conditions such as bathrooms, washrooms, or around indoor swimming pools.
- Do not use the device in dusty or dirty environments.
- Make sure that adequate ventilation is available on all sides of the device.
- Do not place the device near heat sources such as radiators.
- Do not expose the device to direct sunlight.
- Do not expose the device to extreme vibrations.

## Power Supply

- Only use the power cable that came with the Kyra.
- Unplug the device when you are not using it for longer periods.
- Never touch the plug with wet hands.
- Always pull the plug when unplugging the device - never the cable.

## Operation

- Never place objects containing liquids on or near the device.
- Place the device on a stable base only. Use a suitable platform.
- Make sure no foreign objects find their way into the chassis. If for some reason this occurs, switch the power off, unplug the device, and consult a Waldorf authorised service centre.
- This device can generate volume levels that may do irreparable damage to your hearing when used with amplifiers, speakers, or headphones. For this reason, you should keep the volume at safe levels.

## Maintenance

- Do not open the device or remove the cover. Refer all service and repair tasks to Waldorf approved service personnel. Kyra contains no user maintainable parts.
- Use only a dry, soft cloth or brush to clean the device. Never use cleaning solutions or similar chemicals. They will damage the surface of the chassis.

## Proper Use

This device is designed exclusively for musical performance. Any other use is prohibited and voids the warranty extended by Waldorf Music. Waldorf Music is not liable for damages due to incorrect use.



Do not place your Kyra anywhere near children, mothers-in-law or pets. This could lead to critical interaction.



# Setup and Connections

The Waldorf Kyra comes complete with:

- the Waldorf Kyra synthesizer
- an external power supply 12V DC/2A
- a printed Quickstart manual

Please ensure all the above items were included. If something is missing, contact your dealer.

We recommend that you save the original packing material for future transport.

## Installation

Unpack and place Kyra on a clean, even surface.

## Connections

In order to get started with your Kyra you will need an AC power outlet, a mixing console (optional), an amplifier, an audio interface and/or an audio monitor such as active speakers or headphones.

You can also use a computer or sequencer to make use of Kyra's MIDI features.

To connect Kyra to your system:

1. Turn all units off.
2. Connect Kyra's **Out A** audio output pair to your mixing console or your computer audio interface. Optionally, connect stereo headphones to the Headphone Output on Kyra or your mixing console.
3. If you are using a computer, connect the Kyra's USB 2.0 port with a USB cable to your computer (Windows or macOS). Windows users will need to install the Kyra USB driver first. Once connected, Kyra becomes available as a MIDI and audio device on your computer.
4. Optionally, you can connect the Kyra's MIDI ports to a computer MIDI interface or to other MIDI devices. You can also use the computer or a sequencer to make use of Kyra's MIDI features.
5. Connect the power supply that came with the Kyra to a suitable AC power outlet.
6. Once all the connections are made, press both the **Transpose** buttons to power up Kyra. After a few seconds, Kyra will be ready to use.
7. Then switch on your computer (if connected), the mixing console and finally the amplifier or active monitor speakers.

## USB Setup

Kyra's USB implementation supports Windows 7 onwards as well as macOS. macOS users do not need to install a driver but until Windows supports USB Audio Class 2.0 (UAC2), Windows users must install the provided driver before using the USB connection; install the driver before connecting the USB port for the first time. It is important to ensure your computer operating system is updated with the latest service packs and updates before installing the driver.

❗ For Windows driver download please go to:  
<http://waldorfmusic.com/kyra>

## Important Notes

- ❗ Kyra takes just a few seconds to start up after which it is ready to play.
- ❗ The overall volume of Kyra (line outputs and headphones) can be controlled with the **Master Volume** control.

❗ If you are not using a mixing console, you can connect Kyra's line outputs directly to an a stereo amplifier or an audio interface. Please use line-level inputs (not a guitar, phono or microphone level input)

❗ Kyra's line outputs deliver balanced line levels. For best results, always use balanced inputs on your amplifier, mixer or audio interface. Use good quality balanced (TRS) cables. You can use unbalanced cables and inputs but the connection will be much more prone to interference, especially for longer cables.

⚠ Before connecting and disconnecting Kyra to power and switching on or off, turn your amplifier's volume control all the way down to avoid any damage due to on/off transient noise. Please take care to ensure the connected device (mixer, amplifier) is compatible with the high level of an electronic instrument. Do not use a microphone, guitar or phono input on your amplifier.

## Rear Panel Connections

Kyra is a stereo instrument. For best results, use a stereo input on your mixer. If your mixer does not have stereo inputs, use two channels and pan them hard left and right to achieve stereo operation.

## Power Control

To switch Kyra on:

Press both the **Transpose** buttons to power up Kyra. After a few seconds, Kyra will be ready to use.

To place Kyra into standby:

Press and hold both **Transpose** buttons. The Transpose LEDs will show a sequence to indicate the progress and Kyra will go into standby once the sequence completes. You can release the buttons at any time during the sequence to cancel. The standby sequence ensures you don't inadvertently power down Kyra.

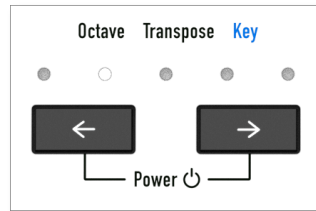

## Headphone Output

Kyra offers a convenient stereo headphone jack. As Kyra has 8 Parts complete with effects and an onboard mixer, it is possible to compose a complete song without any out-board audio equipment (e.g. a mixer or amplifier) purely by using the headphone output. In a typical setup though, a mixer (either analogue or digital in the form of a DAW) would be useful for most projects. For recording, please use the line out connectors and avoid recording from the headphone output or using it as a line out. Also note that only Parts assigned to Output A will be heard on the headphone output - the headphone output is a mirror of analogue Output A. Use the **Master Volume** control to set the level of the headphone output (as well as the stereo line outs).

! We recommend you use good quality stereo headphones with a nominal impedance of 32 ohms with Kyra.

## Line Outputs

Kyra offers four balanced, stereo outputs which are connected to four internal stereo busses A to D. Each of Kyra's 8 Parts can be assigned to one of these outputs. By default, all Parts are assigned to Bus A (and hence Output A and the headphone jack). Multiple outputs allow you to process the audio with a mixer and outboard equipment (e.g. effect units) with total freedom to assign the Parts as desired.

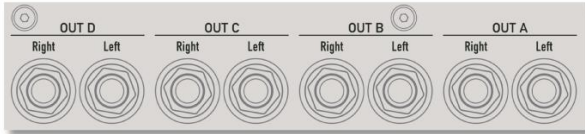

Connect both connectors of each output pair used to ensure the complete stereo signal is available. If your mixer only has mono inputs, use two inputs and pan them hard left and right to ensure the stereo signal is maintained. Kyra does not detect a missing connector and mix down to mono and connecting just one side of a stereo pair may result in some sounds being lost.

When using an external mixer, set Kyra's **Master Volume** control to its maximum level and use the mixer's trim and fader controls to obtain the correct levels. This, along with the use of good quality balanced cabling, will ensure the best quality signal.

The line outputs use components often found in high end hi-fi including audiophile grade Japanese capacitors and ultra-low noise operational amplifiers. As a result, the outputs are of exceptionally high quality and have a high dynamic range.

## USB Port

Kyra offers a USB 2.0 device connector to allow connection to a computer. Kyra's USB can exchange MIDI information, send the audio from each of its 8 stereo Parts to a computer and receive one stereo audio return from the computer. Note that a USB 2.0 connection (or above) is required; Kyra will not connect to a legacy USB 1.x port (also known as 'low speed' or 'full speed').



⚠ Until Windows provides native support for USB Audio Class 2.0, Windows users will need to install the Kyra driver before being able to use Kyra's USB port. Only versions of Windows 7 onwards are supported. Apple macOS users do not need to install a driver.

⚠ For driver download please go to: <http://waldorfmusic.com/kyra>

Kyra has a robust USB port designed to be resistant to accidental disconnection. Be sure to unplug the cable by holding the connector body rather than the cable itself.

⚠ Please ensure you use a USB 2.0 (or above) port on your computer as well as a USB 2.0 certified cable to avoid problems with data transmission (MIDI and audio).

### MIDI Jacks

Kyra offers a full MIDI implementation using 5 pin DIN MIDI connectors. Connect these to your MIDI-equipped devices such as a master keyboard, DAW/sequencer or other instruments.

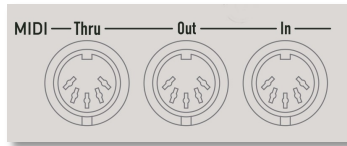

For best performance in a studio environment, we recommended you operate Kyra using USB MIDI. USB on Kyra operates over 30 times faster than DIN MIDI. This allows you to perform complex compositions with embedded MIDI Systems Exclusive messages that would be beyond the capability of DIN MIDI without loss of timing. Kyra

provides full support for DIN MIDI if your setup requires it. One good use for DIN MIDI is for simple 'at the keyboard' playing (i.e. no computer). As keyboards and sound modules (including Kyra) only have Type B USB connectors, you can't connect a keyboard directly to Kyra using USB but you can with DIN MIDI. Any USB-based configuration requires the use of a computer with a suitable MIDI-capable application installed on it.

### Physical Security

Users operating Kyra in areas with public or shared access such as live gigs, public studios or educational establishments can attach a Kensington® compatible security lock to the slot on the rear panel of Kyra.



# System Overview

## Introduction

Kyra features 8 independent 'Parts'. Each Part is effectively a complete synthesizer with sound sources, filters, modulators, multi effects unit and USB audio output. The only resource they share are the line outputs and the pool of 128 hardware voices. Each Part has its own configuration and hosts a Patch from the pool of Patches available to the system. Kyra is truly multitimbral.

## MIDI

Each Part has an assigned MIDI channel and will only respond to channel messages on its assigned channel. A Part can have the same MIDI channel as another Part. In this case, the Parts are 'layered' and will sound together in response to channel messages. You can use Part note ranges ('splits') such that Parts can be restricted to ranges of MIDI notes. Kyra supports MIDI via DIN MIDI connectors and USB.

⚠ You can use USB and DIN MIDI Ins at the same time but it is important not to send MIDI data on the same channel to both ports – doing so is likely to cause stuck or missing notes.

## Line Outputs

The diagram below shows how Kyra's 8 Parts map to USB for audio and MIDI as well as to the four stereo line outputs:

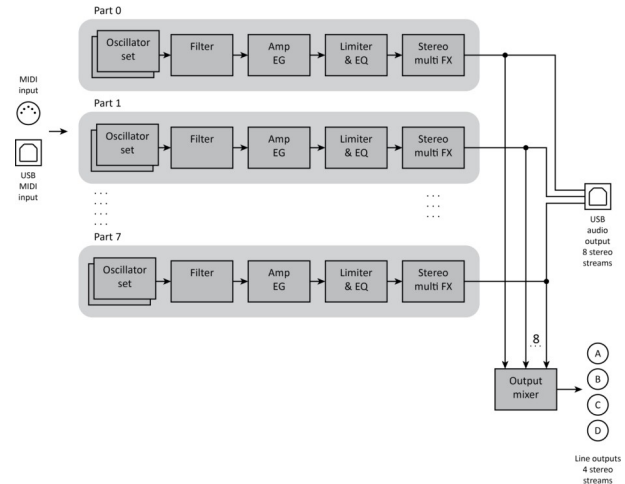

Kyra features four stereo outputs labelled A-D. Each Part can be freely routed to any one of the four outputs, regardless of how many other Parts are using that same output (so if more than one Part is sent to the same output, they will be mixed together). Multiple outputs offer the ability

to connect Kyra to a mixer and/or outboard effects units to further extend possibilities. The headphone output mirrors Output A. Bear in mind that any Part configured to use an Output other than A will not be heard on the headphone output.

## Master Volume

The **Master Volume** control is used to adjust the levels of the line outputs. The control has two purposes:

- To set a comfortable listening level when using Kyra's headphone output
- To provide adjustment in live scenarios when the outputs are connected directly to an amplifier that is not within easy reach or to an unattended mixer.

In all other cases, the **Master Volume** control should be set at or near its maximum setting.

The setting is automatically stored. Use the Patch Level setting to provide level matching between Patches as well as to provide modulation effects that target the Patch level. Use Part levels to mix the relative volumes of the Parts. These can both be modulated smoothly at a much higher resolution than the **Master Volume** control is able to achieve.

## Patch Banks

Kyra has a generous Patch storage capacity of 26 banks (A-Z) each containing 128 Patches. That's a total of 3328.

The first 7 banks (A-G) are 'User' Patches stored in RAM (Random Access Memory) which means you can change them quickly and individually using the Store sequence. The remaining 19 banks (H-Z) are ROM (Read-only Memory) Patches which you can recall and use just like RAM Patches, but you can't replace using the Store sequence. You can freely copy whole banks between RAM and ROM.

You can use any of the Patches in your live performances by selecting the Bank and Patch using the dedicated Bank and Patch buttons. Similarly, you can select any of the Patches from your master keyboard or DAW by using MIDI Bank Select messages to select the Bank and MIDI Program Change messages to select the Patch. Consult the manual for your master keyboard or DAW for help with Bank select messages



Here at Waldorf we know how much time it takes to craft Patches. **Please remember to back up your Patch banks.**

## Basic Controls

### Power Control

To power Kyra up, press both the **Transpose** buttons simultaneously.

Kyra will power up and be ready for use in a few seconds. It might take a few extra seconds to start if there has been a software update or a Patch bank copy instruction.

To place Kyra into standby mode, press and hold both the **Transpose** buttons simultaneously.

To prevent inadvertent shutdown, you'll need to hold the buttons down for about five seconds; the transpose LEDs will indicate the progress of the shutdown. You can release the buttons at any time before the shutdown occurs to cancel the process.

### Display Screen

The display is the primary user interface for Kyra. The display is updated in real time to show the status of the synthesizer.

When Kyra starts, the home page is shown. This page shows the status of the currently selected Part.

Use the **Part** buttons to select the current Part - the display will change to show the status of the selected Part.

! You can return to the home page at any time using the **Exit** button.

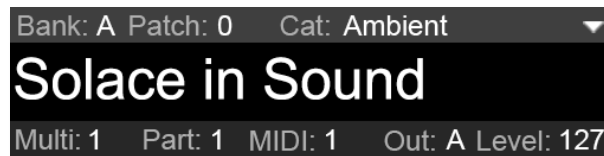

Use the **Page Up/Down** and **Cursor Up/Down** buttons to navigate the pages for each of the three Edit Modes Kyra can operate in, namely Patch, Multi and System Edit. To return to the Home page, press the **Exit** button.

If Follow Mode is engaged (**Follow** button lit), the display will switch to show the parameter being edited when a control is used (i.e. a control or a button). If Follow mode is not engaged, the display will stay as it is (unless the parameter being edited happens to be on the display).

Note that if a parameter is changed by MIDI and it is being displayed, the value shown will change to reflect the change made by MIDI. MIDI updates will not cause the display to switch though, regardless of the Follow Mode.



## Rotary Controls

Kyra's rotary controls provide real time control over many of the instrument's parameters. Most controls carry two parameters, a primary and a secondary parameter. The primary parameter is controlled when Shift Lock mode is off (**Shift Lock** button LED off) and the parameter controlled is that described under the control. The secondary parameter is controlled when Shift Lock is on (**Shift Lock** button LED on) and the parameter controlled is that described above the control. Some controls have no secondary function and controls in the Effects section have up to six different controlled parameters depending on the Effects Select mode selected with the Effects button.

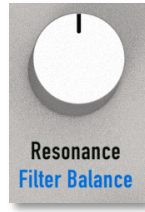

A few controls have an additional secondary function only when the Oscillator Groups are in Hypersaw Mode. These controls have bold blue legends.

It is possible to set values accurately with the rotary controls but if you want a precise value, a good strategy is to set the approximate value with the rotary control and then use the **Value** buttons to nudge the value to exactly the right number. The two sets of controls work well with each other.

## System Controls

The System control buttons are located at the centre of the control panel beside the display. These buttons provide access to the core control features of Kyra.

### Page Buttons

The two **Page** buttons are used to navigate the pages in the Edit Path of the current Edit Mode. Note that Kyra does not hide any pages, so some pages appear that may not be relevant to the current configuration (e.g. wave parameters when the Patch is in Hypersaw Mode). The Edit Path will cycle round if the first or last page are navigated past. The **Page** buttons only operate in Edit Mode and are not used otherwise.

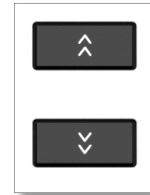

### Cursor Up/Down Buttons

The **Cursor** buttons fulfil a similar purpose to the **Page** buttons but move the cursor one parameter at a time rather than one page at a time. Scrolling the cursor off the top or bottom of the page will move to the previous or next page, respectively. You

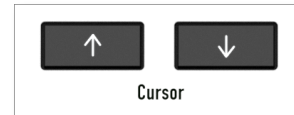

can use the **Cursor Down** button as a shortcut to enter Patch Edit Mode.

otherwise any changes you made will be lost if you change the Patch or Multi.

## Value Buttons

The **Value** buttons adjust the value highlighted by the cursor when in Edit Mode. You can adjust most Patch values using the controls and buttons but all parameters, including those not related to Patches, can also be adjusted using the **Value** buttons. Note that the **Value** buttons are useful for making small adjustments to Patch values leaving the rotary controls for larger changes and then nudging the last one or two value changes with the Value buttons. The **Value** buttons select the character under the cursor in Text Edit mode. The **Value** buttons support auto-repeat to allow fast changes to parameters. Simply press and hold the button for a second or so to engage auto-repeat.

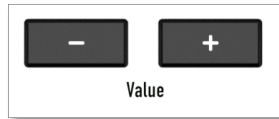

## Exit Button

The **Exit** button ends the current edit session and returns to the home page. Exit itself does not discard any changes but you will need to save your Patch (or Multi)

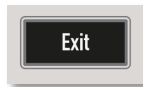

## Edit Buttons

The **Edit** buttons engage one of the three Edit Modes by changing to the first page in the relevant Edit Path. An Edit Path is a sequence of pages used to control one of the three core settings groups within Kyra, namely, Patch, Multi and the System configuration. Sequential presses on an **Edit** button will step through the key pages of the Edit path. Note that changing any parameter will enter Patch or Multi Edit mode automatically. Use the **Exit** button to return to the home page.



## Follow Button

The **Follow** button toggles Follow Mode on and off. The button lights to indicate Follow Mode is engaged.



When in Follow Mode, changing any control will engage Edit Mode and cause the display to switch to the page hosting the parameter so you can see the change you are making. In most cases this is useful but if you are editing one group of parameters using the **Value** buttons and want to make a quick change to another parameter without losing your context, switching off Follow Mode allows

for this. When switched off, changing a parameter will not cause the page to switch. Finally, you can move more than one control at the same time but if the parameters are on different pages, having Follow Mode on will cause the display to flip between the pages. In this situation, switch off Follow Mode.

Almost all Follow Mode page changes will engage Patch Edit Mode as most controls relate to Patch parameters but there are some exceptions. For example, Transpose is a Part parameter so using the **Transpose** buttons whilst in Follow Mode will engage Multi Edit Mode and switch to the Multi Edit page. You can always use the **Exit** button to return to the Home page.

## Undo Button

**Undo** reverses the last Patch edit made. Undo is single level only, so if you press **Undo** again it will 'redo' and change the value back to the edited value. So, you can use **Undo** to compare the effects of a parameter change by repeatedly pressing **Undo**.



Note that the base value (the value **Undo** will revert to) is the value of the parameter as it was when it was first changed. So, if you change a parameter and then change it again, Undo will revert to the original value. **Undo** only

works for Patch parameters, it does not apply to Multi or Configuration changes. **Undo** is useful for inspecting Patch parameter values. If you want to check the value of a parameter, check you're in Follow mode and press the button or turn the control that controls the parameter you want to inspect. Then press **Undo**. This will ensure the display shows the original, effective value of the parameter. **Undo** still works if you're not in Follow Mode, the only difference is the display won't change to show the parameter.

A final use of **Undo** is to reverse an inadvertent or unexpected change in a parameter.

### Store Button

The **Store** button starts the sequence to write the current Patch of the current Part (if in Patch Edit or no edit mode) or the current Multi (if in Multi Edit mode) to memory. The **Store** button will light when the store sequence is in progress. The display will guide you through the steps involved including the last stage, Text Editor Mode, which allows you to give a Patch a name up to 22 characters in length.

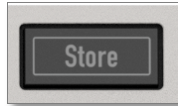

⚠ You can press **Exit** at any time in the process to cancel without storing (the changes made are still in the Edit Buffer up until the time you change the Patch/Multi or power Kyra down).

⚠ The **Store** button also lights during a firmware update. It is important not to power Kyra down at this time.

⚠ As Kyra uses a proportional font, it is possible for some characters in a Patch name to be truncated. If this happens, please consider using a shorter name for the Patch.

You can use the **Cursor** buttons to back up in the store sequence so that you can change which Patch you're going to overwrite. In the second step, the location and name of the Patch you're going to overwrite is displayed so you can check you're not overwriting a Patch you want to keep.

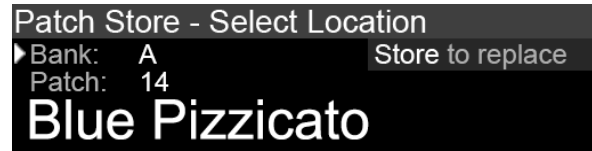

If you've made an edit to a RAM Patch and want to quickly save your change over the existing Patch, simply press the **Store** button four times in a row to update the Patch and return to the Home page. Be careful when editing ROM patches (banks H-Z) as it is not possible to store Patches back in these banks and the Store sequence will default to A-0. Be sure to select the correct destination Patch in one of the RAM banks (A-G) during the Store sequence.

Even though you can't store a Patch directly to ROM you can copy whole Banks of Patches to (and from) ROM using the Copy Patch Bank function.

Each Part maintains a Patch Edit buffer and Kyra maintains a single Multi Edit buffer. As front panel controls are manipulated, these changes are reflected in the Edit buffer of the current Part (as shown on the bottom row of the display). As there is an Edit Buffer per Part, changing the current Part does not discard the edits you made to the Part that was selected before but note that changes are not stored until the store sequence is completed for the specific Part that was changed.

Storing a Multi does not result in the Patch Edit buffers being stored; even though you can have all eight Parts with pending changes it makes sense to store them (or discard them by recalling the Patch) before you move to the next Part. If you don't do this, it is easy to lose track of which Parts you changed and forget to store them. Edit Buffers

(for Parts and Multis) are lost when Kyra is powered down.

If you edit a Patch that is loaded into more than one Part, the changes will be reflected in the Edit buffer of all Parts hosting the Patch. If you want the Patches to be independent on each Part, make a copy of the Patch and select it in to the relevant Part.

Front panel controls are always responsive and any changes made to a Patch right up until the last stage of the Store sequence is done will be stored along with the Patch; you can still make changes (including inadvertent ones) during the Store Sequence. As Follow Mode is disabled during the Store sequence, you may not realise you changed something inadvertently so be careful not to accidentally nudge any controls. If you do, exit the Store sequence and use Undo to back out the change before storing the Patch.

Finally, note that it can take a few seconds for Kyra to commit a Patch or Multi to memory. You can keep playing and editing other Patches during this time but don't power Kyra down during this time otherwise you may lose your changes. This includes changes made by MIDI such as received SysEx Patch dumps.

## Shift Lock Button

The **Shift Lock** button toggles Shift Mode and allows access to the second function that most controls have. To ease single-handed operation, the **Shift Lock** button latches (push on, push off) and has an LED to indicate its status. It's worth getting into the habit of knowing what state **Shift Lock** is in to avoid inadvertently changing a parameter although the change won't be stored unless you go through the Store sequence and you can always undo the change. Shift Mode can be in either state for controls that only have one function.

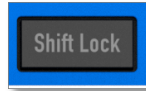

⚠ **Shift Mode** is automatically disengaged when you use the **Exit** button to revert to the home page.

## Navigation Controls

### Multi Buttons

The **Multi** buttons allow you to select the current Multi. A Multi is a stored configuration of all 8 Parts including references to (as opposed to copies of) the Patches loaded into the Parts at the time the Multi was stored.

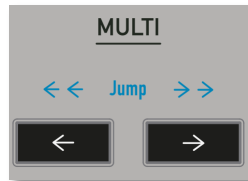

Changing the Multi will, therefore, instantly reconfigure all 8 Parts. The current Multi is shown on the bottom line of the home page. If Shift Mode is enabled, the **Multi** buttons skip by ten rather than by one.

### Part Buttons

The **Part** buttons allow you to select which Part is the current Edit Target. In other words, which Part will be 'connected' to the Front Panel. You can move freely between the Parts using the **Part** buttons and make changes as required to each Part although remember to use the Store sequence on each Part changed if you want to keep the changes. A Store sequence will only save the changes made to the Patch in the current Part. The current Part is shown on the bottom line of the home page. Be sure to check it is as expected when working on more than one Part at a time. If what you hear doesn't seem to match what you're editing, check that the current Part is the one you're working with.

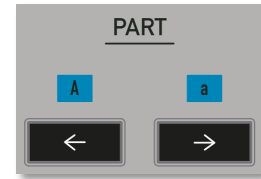

The **Part** buttons also fulfil a third function of selecting capital 'A' (left Part button) or lower case 'a' (right Part button) when in Text Editor Mode.

## Bank Buttons

The **Bank** buttons allow you to select the Bank from which Patches are selected. Changing the Bank will change to the Bank selected by selecting the current Patch number (0-127) in the new Bank. To differentiate them from Patch numbers, Banks are assigned a letter A-Z and the current Bank is shown on the top line of the Home page. The **Bank** buttons do not operate when the Category Filter is active.

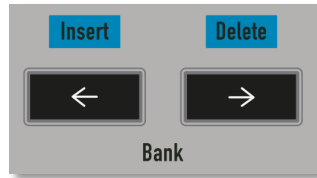

In Text Editor Mode, the left **Bank** button will Insert a space at the cursor position and the right **Bank** button will delete the character at the cursor position and close the gap. These controls are very useful for rapid creation and editing of Patch names.

## Patch Buttons

The **Patch** buttons allow you to select the Patch to be loaded into the current Part. The current Part is displayed on the top line

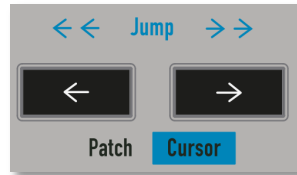

of the Home page. The **Patch** buttons support auto-repeat and wrap round the 128 Patches in a Bank. Note that changing Patch (using the Patch buttons or via MIDI) will discard any changes that were made to the current Patch unless you had stored them using the Store sequence beforehand. If Shift Mode is enabled, the Patch buttons will move through the Bank in steps of ten but will not wrap round. You can only change Patches (including the Bank) when the Home page is displayed. Press **Exit** at any time to return to the Home page.

The Patch name is shown in the centre part of the Home page.

When the Category Filter is enabled, the **Patch** buttons select the next or previous Patch and Bank of the category selected in the category filter (regardless of which Bank it is in). The category selection on the Home page flashes to indicate that the category filter is active. Note that if the Category Filter is set to a category for which no Patches exist, the **Patch** select buttons revert to their standard function of selecting the next or previous Patch regardless of category.

In Text Editor Mode, the left **Patch** button moves the cursor left and the right **Patch** button moves the cursor right to allow rapid navigation to any part of the Patch name.

## Transpose Buttons

The **Transpose** buttons allow the current Part to be transposed - either in octave or semitone steps.

If Shift Mode is not engaged, these buttons will transpose the currently selected Part in one octave steps. If Shift Mode is engaged, the **Transpose** buttons will transpose in semitone steps instead. The maximum amount of transposition is two octaves (24 semitones) either side of the base note key.

Note that transpose is not a Patch parameter. It is a Part parameter and by transposing, you are modifying the Part. This value will only be stored if you store the current Multi. Otherwise, the change will be lost when the Multi is changed or the unit is powered down (although it is retained when a Patch is changed as it is not a Patch parameter). Recall that because each Part has its own transpose settings, if you want to transpose all Parts to a new key (or octave) you'll need to change the transpose setting in all active Parts - you may wish to do this on your master keyboard or in your DAW instead as the front panel transpose feature is intended more as a single Part performance

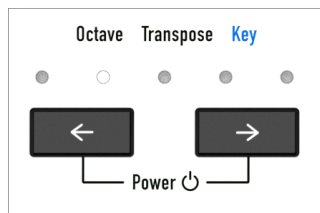

function. A benefit to having a transpose for each Part is that you can easily configure Parts to play in different keys (or octaves), even if they are on the same MIDI channel (i.e. layered).

Finally, note that transposing shifts the pitch notes play at. You may have to adjust the filter tracking key of your Patch relies on the pitch of the oscillators and filters tracking accurately. Transposing has an immediate effect and does not stop any current notes playing so you can use it during a performance. The LEDs indicate the octave range of the current transposition. The centre LED, when lit at full brightness, indicates no transpose is in effect for the current Part. It lights at reduced brightness, along with one of the octave range LEDs to indicate that a key change is in effect (i.e. a transposition by a value other than a complete octave). An LED lit without the centre LED indicates an octave transpose is in effect but there is no key change. This means that when transposing in semitone steps, the LEDs might not change as the octave could be unchanged.

⚠ The **Transpose** buttons are also used to start Kyra up and place it into standby.



## The Control Panel Sections

### The Voice Controls

#### Dual Mode

The **Dual Mode** button configures the voice for Dual Mode that uses two hardware voices for additional depth, stereo width and presence. Dual Mode can apply to a Wave or Hypersaw Patch. Please refer to the section on Sound Programming for more information. Changes to Dual Mode take effect when new notes are played. When Dual Mode is selected, you can detune the two voices using the Dual Detune function.



#### Dual Filter

The **Dual Filter** button configures the voice for Dual Filter Mode that uses two parallel filters to provide a true stereo signal path. Selecting Dual Filter Mode will also select Dual Mode as Dual Filter mode similarly uses two hardware voices per note. Please refer to the section on Sound Programming for more information. Setting Dual Filter Mode will switch Voice Mode to Wave



Mode. Two filters are used in Dual Mode Hypersaw but the second filter is managed automatically.

#### Master Volume

The **Master Volume** control sets the overall volume of the line outputs (including the headphones output). Note that Master Volume is a System Configuration parameter and the value set is used next time Kyra is powered up. Use the **Master Volume** control to set a comfortable listening volume on your headphones. Set **Master Volume** at its maximum setting when using an external mixer. The **Master Volume** control has a relatively coarse 0.5dB granularity. A slight stepping may be heard on very deep pads if the **Master Volume** is changed.

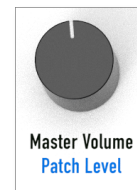

#### Portamento

Sets the portamento time of the Patch. The portamento time is the time taken for a note to glide to its target pitch (i.e. the note played). The time is independent of the interval that needs to be spanned (so larger intervals will move faster to achieve the configured time). Turn this control to zero to switch off portamento. In Mono Play Mode, portamento only occurs if notes are played legato. Staccato notes suspend any selected portamento.

## Voice Control Pages and Parameters

The Voice Control Pages can be accessed by pressing the **Patch Edit** button. The first of the three Voice Control pages is shown below:



### Patch Volume

! You can adjust the Patch Volume setting using the **Master Volume** control with Shift Mode engaged.

Use Patch Volume to match the relative levels of patches. You can automate the Patch Final Level parameter using MIDI CC messages or the Mod Matrix for smooth fade ins/fade outs.

### Voice Mode

! Please see the descriptions of the voice mode buttons (**Wave Mode** and **Hypersaw Mode**).

## Dual Mode

! Please see the description of the **Dual Mode** button.

## Panorama

! You can adjust **Panorama** using the **Portamento** control with Shift Mode engaged.

The Panorama setting controls how far from centre the two voices of a Dual Mode Patch are spread apart. In Dual Mode, the two voices will be panned apart around the point configured in by the **Patch Pan** control. The width of that panning is set by the **Panorama** control. At zero, the Dual Mode sound will be based around a single point in the stereo stage. At maximum setting (the default) the two voices will be panned in opposing positions to achieve maximum stereo width. Keep this at a high setting unless you need to specifically limit the width of a Dual Mode Patch. If you need to limit it significantly it might be worth reviewing if the Patch needs to be in Dual Mode at all. At zero setting, there is no stereo imaging and the rich stereo width, which is the primary benefit of Dual Mode, will be absent. Note that the **Panorama** control is applied before any effects so narrowing the width does not narrow the stereo effects subsequently applied to the Patch. When

configured for Dual Mode, Kyra provides a complete stereo signal path.

The second of the three Voice Control pages is shown below:

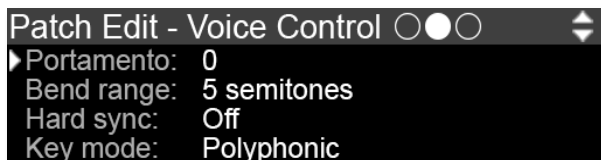

### Portamento

⚠ Please see the description of the **Portamento** control.

### Bend Range

⚠ You can adjust the **Bend Range** using the EG1/3 **Attack** control with Shift Mode engaged.

This control sets the range (in semitones) applied by the channel Pitch Bend controller for the Part. The bend range can be between 0 and 12 semitones. The zero setting is provided so that the Pitch Bend control can be used for alternative purposes via the Mod Matrix.

### Hard Sync

⚠ Please see the description of the **Hard Sync** function.

### Key Mode

Key Mode has no physical control and is only available on the Voice Control page. Key Mode limits the Part to only play a single note at a time (monophonic). This is useful for specific sounds such as basses. If the Patch has any portamento, it will only glide for notes played legato - staccato notes will suspend the portamento effect.

For normal polyphonic play, ensure this is set to Polyphonic. Enabling the Arpeggiator will switch off monophonic key mode.

The third and final Voice Control page is shown below:

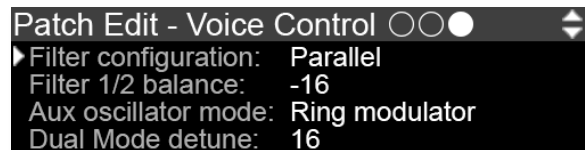

## Filter Configuration

⚠ Please see the description of the **Dual Filter** button.

## Filter 1 / 2 Balance

⚠ You can adjust the **Filter 1 / 2 Balance** using the filter **Resonance** control with Shift Mode engaged.

Sets the balance between the two filters. This only has any effect if Dual Filter Mode is engaged. If it is, negative values will mix Oscillator Group 1's signal path higher, positive values will mix Oscillator Group 2's signal path higher. The default value of zero, which is the centre point of the control's range, balances the two signal paths equally. At either extreme, only one of the Oscillator Groups will be heard. Filter Balance is a Mod Matrix destination.

 Modulating Filter 1 / 2 Balance via the Mod Matrix is a very creative technique.

## Aux Oscillator Mode

This function has no physical control. A fast way to navigate to this parameter is to press the **Patch Edit** button and then the **Cursor Down** button twice.

The Aux Oscillator is in fact two oscillators, one located in each of the Oscillator Groups. The Aux Oscillator can be configured to produce white noise or a ring modulated product of the wavetables in each Oscillator Group. As a result, a Patch can have white noise or ring modulation but not both.

## Dual Mode Detune

⚠ You can adjust **Dual Detune** using the EG1/3 **Release** control with Shift Mode engaged.

This control sets the amount of Dual Mode Detune applied to a Dual Mode configuration. This allows you to detune the two voices in a Dual Mode configuration by up to half semitone (50 cents) in each direction relative to the basic pitch of the note. One of the voices is flattened and the other is sharpened by the same interval configured by Dual Mode Detune.

This adds considerable depth and movement to Dual Mode Wave Patches. Dual Mode Detune is a polyphonic Mod Matrix destination. It's a good idea to add at least a small amount of detuning to all Dual Mode Wave Patches to avoid them sounding hollow and 'phasey'.

 With a Dual Mode Patch, Try routing channel pressure (aftertouch) or Velocity to Dual Detune.

## Oscillator Groups

Kyra has several sound sources that are grouped into two independent Oscillator Groups. Within in each Oscillator Group there are several sound sources (oscillators) which can be used to craft sounds. All the oscillators in an Oscillator Group have the same frequency (pitch) except the Sub Oscillator which can be one octave lower and can be detuned as well. It is possible to detune the pitch between the two Oscillator Groups.

## The Voice Oscillator Mode Buttons

The **Wave Mode** and **Hypersaw Mode** buttons select how Kyra's oscillators are configured.

### Wave Mode

Use the **Wave Mode** button to configure the voice for Wave mode. Kyra adopts a virtual analogue synthesis model which has the advantage that it is easy to construct sounds using intuitive subtractive synthesis.

By default, the two Oscillator Groups in the voice are mixed together and routed to a single filter, Filter 1. If Dual Mode is selected, the Oscillator Groups are routed separa-

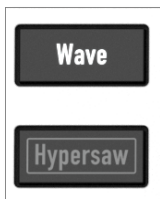

tely to two filters. If Dual Filter Mode is not selected, two filters are still used for stereo operation but they are controlled by the settings for Filter 1 so there is one Filter to configure but a true stereo signal path. Stereo LFOs can still modulate the two filters independently in Dual Mode.

If Dual Filter Mode is selected, the signal routing is the same but the two filters can be controlled individually using the Filter 1 and Filter 2 controls in the Filter section. Between them, these settings allow for a lot of flexibility in signal routing.

ⓘ Please refer to the Sound Programming section for more information on Wave Mode.

## Hypersaw Mode

Use the **Hypersaw Button** to configure the voice for Hypersaw Mode. Kyra's hypersaw uses a special algorithm comprising six real oscillators to create lush soundscapes quickly. Hypersaw Mode replaces Wave Mode's two Oscillator Groups with a single source whose tonal content is constructed with just two controls, **Intensity** and **Spread**. Built entirely out of multiple, harmonically-rich sawtooth waves (referred to as 'partials') each adjusted according to a special algorithm, the Hypersaw provides characteristic soundscapes ideal for a range of uses from high impact lead sounds through to lush, animated pads.

When Dual Mode is selected, the hypersaw algorithm is doubled to use twelve oscillators and two filters are used for a true stereo signal path.



The **Panorama** control allows you to configure the width of the stereo hypersaw.

- ⓘ Please refer to the Sound Programming section for more information on Hypersaw Mode.
- ⓘ You can't activate Dual Filters Mode for a Dual Mode Hypersaw. In Dual Mode Hypersaw, the two filters are controlled together as Filter 1.

## Oscillator Group 1 Controls



### Select

The Oscillator Group **Select** button allows quick access to the Oscillator Group 1 parameters for inspection or modification. Each press of the button will scroll through the page groups that display the Oscillator Group's parameters. Use the **Cursor Up/Down** buttons to access intermediate pages.

### Tune

The **Tune** control sets the pitch of Oscillator Group 1 in semitone steps from minus two to plus two octaves (relative to the pitch the note should be for the MIDI note play-

ed). Note that there is no detune control (or parameter) for Oscillator Group 1 as it is the root pitch although detune does exist for Oscillator Group 1 as a Mod Matrix destination.



Using the Mod Matrix for routing the Random per Note source to Detune is a great way to make tracks sound more varied and 'humanised'. Remember to apply it to both Oscillator Groups in Wave Mode voices.

### Hard Sync

The **Hard Sync** button selects hard sync (hard synchronisation) between the two Oscillator Groups. Note that Aux and Sub Oscillators are not synchronised when hard sync is enabled; the sub Oscillator can always be tuned independently. Selecting Hard Sync when FM is in use (non-zero amount) is not recommended as the two algorithms are contradictory and do not produce a useful result (usually out of tune) when used together. Hard Sync applies only in Wave Mode.



There's more information about Hard Sync in the Sound Programming section of this manual.

### Pulse Width

In Wave Mode, the **Pulse Width** control sets the pulse width of the pulse component of the Oscillator Group.

### Saw Level

In Wave mode, the **Saw Level** control sets the basic level of the sawtooth component of the Oscillator Group.

### Wave Level

In Wave mode, the **Wave Level** control sets the level of the wavetable component of the Oscillator Group.

### Pulse Level

In Wave Mode, the **Pulse Level** control sets the level of the pulse component of the Oscillator Group.

## Oscillator Group 1 & Hypersaw Pages

You can navigate to the Oscillator Group 1 Control page using the Oscillator Group 1 **Select** button or by changing a control in the group with Follow Mode engaged. All parameters shown have physical controls.



### Oscillator 1 Coarse Tune

⚠ Please see the description of the **Oscillator Group 1 Tune** control.

### Oscillator 1 Wavetable 2 FM

This controls sets the amount of FM (frequency modulation) of the three core Oscillator Group 1 source (sawtooth, pulse and wavetable) from Oscillator Group 2's wavetable.

⚠ There's more information about FM on Kyra in the Sound Programming section of this manual.

### LFO1 to Pitch

⚠ You can adjust amount of **LFO1 to Pitch** using the **Saw Level** control with Shift Mode engaged.

This control sets the amount of hard-wired modulation from LFO1 to Pitch. It is only effective in Wave Mode. Please use the LFO1 to Pitch control in Oscillator Group 1 to apply modulation to the hypersaw.

Remember that the Oscillator Groups modulations are independent so if you apply a modulation, such as LFO1 to Pitch, to Oscillator Group 1, it does not affect Oscillator Group 2. If you want both groups to be modulated in the same way (e.g. the same pitch modulation using LFO1 to Pitch) you must set the modulation in both Oscillator Groups. This gives you maximum flexibility as you can modulate the two groups by different amounts to get all sorts of useful effects.

🎧 Applying stereo LFOs and different modulating shapes to Oscillator Pitch can produce some amazing effects.



## LFO2 to Pulse Width

⚠ You can adjust amount of **LFO2 to Pulse Width** using the **Pulse Width** control with Shift Mode engaged.

Sets the amount of Pulse Width Modulation (PWM) from LFO2.

⚡⚡ Modulating the Pulse Width of a pulse wave using a modulator (such as an LFO) is an all-time classic synthesizer technique. Kyra provides a hard-wired routing from LFO 1 or a flexible routing via the Mod Matrix.

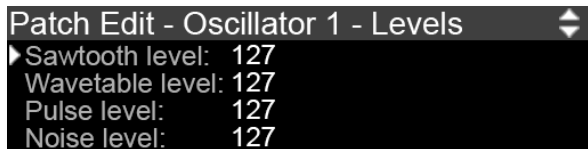

## Sawtooth Level

⚠ Please see the description of the Oscillator Group 1 **Saw Level** control.

## Wavetable Level

⚠ Please see the description of the Oscillator Group 1 **Wave Level** control.

## Pulse Level

⚠ Please see the description of the Oscillator Group 1 **Pulse Level** control.

## Aux (Noise or Ring Mod) Level

⚠ You can adjust **Aux Level** using the **Pulse Level** control with Shift Mode engaged.

Sets the level of the Auxiliary (Aux) Oscillator. The Aux Oscillator produces noise (an unpitched sound) or the output of the Ring Modulator depending on the Aux Oscillator function selected on the Voice Control page.

## Wave Group & Wave Number

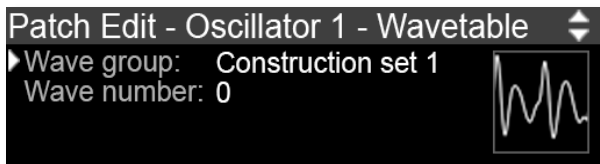

The Wavetable Navigator for the Oscillator Group can be accessed by pressing the Oscillator Group 1 **Select** button until the navigator is shown (three times from the Home page). Use the Wavetable Navigator to select the wavetable required for Oscillator Group 1. The 4096 tables are grouped by genre to make selection easier. For your reference, the page also shows the waveform of the wavetable selected.

⚠ Hypersaw controls are effective only if the voice is configured for Hypersaw Mode.

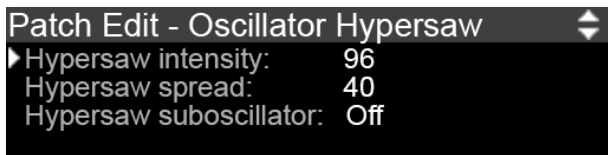

## Hypersaw Intensity

The **Hypersaw Intensity** control sets the intensity of the Hypersaw. The algorithm operates by rolling off the hypersaw partials as they deviate from the root frequency. The intensity control sets the rate of that rolloff. Higher settings result in a stronger presence of more partials yielding a more intense hypersaw.

## Hypersaw Spread

The **Hypersaw Spread** control sets the spread of the Hypersaw. The algorithm operates by deviating (detuning) the frequency of the hypersaw partials from the fundamental note. The spread control sets the amount of deviation between the partials. Note that Hypersaw Spread is a Mod Matrix destination and can therefore be modified by any modulation source. This is a very effective technique.

## Hypersaw Sub Oscillator

When switched on, the two partials furthest from the fundamental are played one octave lower. This gives the hypersaw sound extra bass presence. There is no physical control for the Hypersaw Sub Oscillator.

## Sub Oscillator 1 & 2 Controls



ⓘ The two Oscillator Groups each have an independent Sub Oscillator ('Subs'). As the parameters and controls for the two Subs are identical, they're only described once here; just remember there are two of them.

⚠ As the Subs can be detuned from their parent Oscillator Group, they offer great potential for 'phattening' sounds. Please be sure to make use of them. Note that the Subs and their controls are only used when the voice is configured for Wave Mode (they are not related to the Hypersaw sub-oscillator).

### Sub Shape

Selects one of the four distinctive waveshape options for the Oscillator Group's Sub Oscillator. The shapes available are sawtooth, square, pulse and triangle.

### Sub Level

Sets the level of the Oscillator Group's Sub Oscillator.

### Sub Octave

Selects whether the oscillator plays at the same pitch as the host Oscillator Group ('root') or one octave below ('sub').

## Sub Oscillator Page

! The fastest way to navigate to the Sub Oscillator page is to select the Sub shape already set (lit) by pressing the relevant **Sub Shape** button.

The page shown is for the Oscillator Group 1 Sub Oscillator but the page for the Oscillator Group 2 Sub Oscillator is similar.

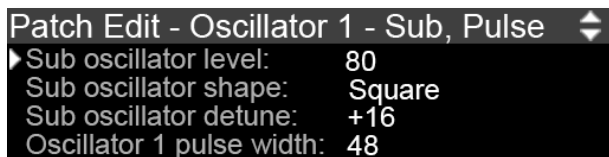

### Sub Oscillator Level

! Please see the description of the relevant **Sub Level** control.

### Sub Oscillator Shape

! Please see the description of the relevant **Sub Shape** buttons.

## Sub Oscillator Detune

! You can adjust the Sub Oscillator Detune using the relevant **Sub Level** control with Shift Mode enabled.

The Sub Oscillator **Detune** control sets the amount of detuning (relative to the parent Oscillator Group) of the Sub Oscillator. The amount of detuning can be up to half a semitone either side. Negative values will flatten the Sub Oscillator and positive values will sharpen it.

### Oscillator 1/2 Pulse Width

! Please see the description of the relevant **Pulse Width** control in the relevant Oscillator Group. Note that this isn't a Sub Oscillator parameter.

## Oscillator Group 2 Controls



ⓘ The operation and controls of Oscillator Group 2 are similar but not identical to that of Oscillator Group 1. For certain functions such as Hard Sync, FM and Ring Modulation, Oscillator Group 2 has a different role to Oscillator Group 1. The basic architecture of the two Groups is the same though.

### Select

The Oscillator Group **Select** button allows quick access to the Oscillator Group 2 parameters for inspection or modification. Each press of the button will scroll through the page groups that display the Oscillator Group's param-

eters. Use the **Cursor Up/Down** buttons to access intermediate pages.

### Tune

The **Tune** control sets the pitch of Oscillator Group 2 in semitone steps from minus two to plus two octaves (relative to the pitch the note should be for the MIDI note played).

### Detune

The **Detune** control sets the pitch of Oscillator Group 2 in sub-cent steps from -50 cents (flatten by one semitone) to +50 cents (sharpen by one semitone).

### Pulse Width

In Wave Mode, the **Pulse Width** controls sets the pulse width of the pulse component of the Oscillator Group.

### Saw Level

In Wave mode, the **Saw Level** control sets the basic level of the sawtooth component of the Oscillator Group.

## Wave Level

In Wave mode, the **Wave Level** control sets the level of the wavetable component of the Oscillator Group.

## Pulse Level

In Wave Mode, the **Pulse Level** control sets the level of the pulse component of the Oscillator Group.

## Oscillator Group 2 Control Pages

You can navigate to the Oscillator Group 2 Control page using the Oscillator Group 2 **Select** button or by changing a control in the group with Follow Mode engaged. All parameters shown have physical controls.

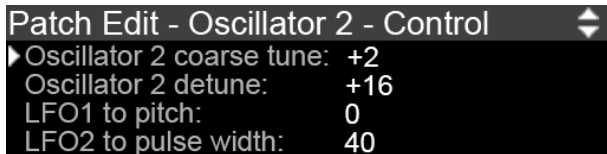

## Oscillator 2 Coarse Tune

⚠ Please see the description of the Oscillator Group 2 **Tune** control.

## Oscillator 2 Detune

⚠ Please see the description of the Oscillator Group 2 **Detune** control.

## LFO1 to Pitch

⚠ You can adjust amount of **LFO1 to Pitch** using the **Saw Level** control with Shift Mode engaged.

This control sets the amount of hard-wired modulation from LFO1 to Pitch. Unlike most of the controls in the Oscillator Group, this parameter applies to Wave and Hypersaw Mode configurations,

Remember that the Oscillator Groups modulations are independent so if you apply a modulation, such as LFO1 to Pitch, to Oscillator Group 2, it does not affect Oscillator Group 1. If you want both groups to be modulated in the same way (e.g. the same pitch modulation using LFO1 to Pitch) you must set the modulation in both Oscillator Groups. This gives you maximum flexibility as you can

modulate the two groups by different amounts to get all sorts of useful effects.

 Applying stereo LFOs and different modulating shapes to Oscillator Pitch can produce some amazing effects.

### LFO2 to Pulse Width

 You can adjust amount of LFO2 to Pulse Width using the **Pulse Width** control with Shift Mode engaged.

Sets the amount of Pulse Width Modulation (PWM) from LFO2.

 Modulating the Pulse Width of a pulse wave using a modulator (such as an LFO) is an all-time classic synthesizer technique. Kyra provides a hard-wired routing from LFO 1 or a flexible routing via the Mod Matrix.

### Patch Edit - Oscillator 2 - Levels

▶ Sawtooth level: 127  
Wavetable level: 64  
Pulse level: 0

### Sawtooth Level

 Please see the description of the Oscillator Group 2 **Saw Level** control.

### Wavetable Level

 Please see the description of the Oscillator Group 2 **Wave Level** control.

### Pulse Level

 Please see the description of the Oscillator Group 2 **Pulse Level** control.

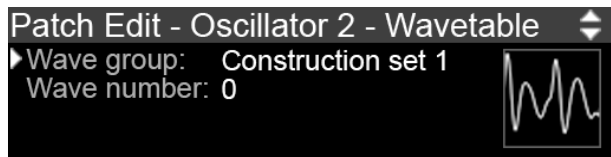

The Wavetable Navigator for the Oscillator Group can be accessed by pressing the Oscillator Group 2 **Select** button until the navigator is shown (three times from the Home page). Use the Wavetable Navigator to select the wavetable required for Oscillator Group 2. The 4096 tables are grouped by type to make selection easier. For your reference, the page also shows the waveform of the wavetable selected.



## Filter Controls



This section describes the function of Kyra's filters.

### Filter Select 1 & 2

The two **Filter Select** buttons select which filter the Filter Group rotary controls apply to. Filter 2 controls only apply when Dual Filter mode is selected. The **Filter Select** buttons are also useful for accessing the Filter parameters quickly; repeated presses of the Filter Select buttons will scroll through the pages related to the Filter selected.

! Press the relevant **Filter Select** button repeatedly to inspect the settings for a filter.

### Filter Type

The six **Filter Type** buttons set the current filter response type. The options are: low pass 2 pole (12dB LP), low pass 4 pole (24dB LP), band pass 2 pole (12dB BP), band pass 4 pole (24dB BP), high pass 2 pole (12dB HP) and high pass 4 pole (24dB HP).

! Please refer to the section on Sound Programming for more information on the filter types.

### Filter Frequency

The **Filter Frequency** control sets the cutoff frequency for the low pass and high pass filter types and the centre frequency for the band pass filter types.

! The Filter Frequency can be controlled using fixed routings of MIDI CC #85 for Filter 1 and MIDI CC #86 for Filter 2.

### Filter Resonance

The **Filter Resonance** control sets the resonance of the filter. Higher values boost the harmonics around the cutoff frequency of the filter. Note that higher values can cause large resonant peaks and ultimately, self-oscillation within the filter. You will need to account for this when setting

levels to avoid distortion in the Limiters although such distortion can be useful at times.

! The Filter Resonance can be controlled using fixed routings of MIDI CC #87 for Filter 1 and MIDI CC #88 for Filter 2.

### EG2 to Frequency

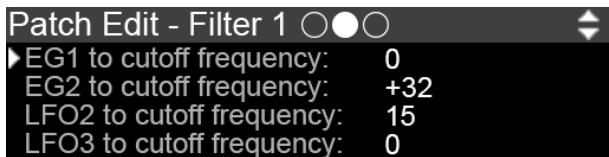

This control sets the amount that Envelope Generator 2 (EG2) modulates the current filter's cutoff frequency. For positive settings, the filter cutoff frequency is increased by the modulation of the envelope, for negative settings, the cutoff frequency is decreased. Use this parameter to change the filter frequency over time. Sounds with a hard attack usually have a positive envelope amount that makes the start phase bright and then closes the filter to get a darker sustain phase. String sounds, on the other hand, usually use a negative envelope amount that gives a slow and dark attack before the cutoff rises in the sustain phase.

! Kyra's filters come to life when they are modulated. A wide range of hardwired modulations are provided and you can always add more possibilities using the Mod Matrix.

! EG2 is designed for filter modulation and has hardwired routes for that purpose. You can of course use the EG for other purposes via the Mod Matrix. The description of the Filter EG controls can be found in the EG section.

### Filters 1 & 2 Pages

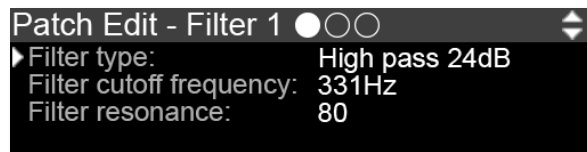

The pages and descriptions below describe Filter 1.

! The parameters, controls and pages for Filter 1 and Filter 2 are identical so only Filter 1 is described here.

## Filter Type

ⓘ Please see the description of the **Filter Type** buttons.

## Filter Cutoff Frequency

ⓘ Please see the description of the **Filter Frequency** control.

## Filter Resonance

ⓘ Please see the description of the **Filter Resonance** control.

## EG1 to Cutoff Frequency

This parameter has no physical control and is only available in the corresponding Filter page. This control is identical to the **EG2 to Cutoff Frequency** control (which does have a physical control) but uses EG1 as the modulation source rather than EG2.

## EG2 to Cutoff Frequency

ⓘ Please see the description of the **EG2 to Frequency** control.

## LFO2 to Cutoff Frequency

ⓘ You can adjust the **LFO2 to Cutoff Frequency** setting using the **EG2 to Frequency** control with Shift Mode engaged.

The **LFO2 to Cutoff Frequency** setting determines the amount that LFO2 modulates the current filter cutoff frequency. LFO modulation is positive bipolar only. If negative LFO modulation is required, use an anti-phase LFO or Mod Matrix routing. If unipolar modulation is required, use a Mod Matrix routing.

## LFO3 to Cutoff Frequency

This parameter has no physical control and is only available in the corresponding Filter page. This control is identical to the **LFO2 to Cutoff Frequency** control (which does have a physical control) but uses LFO3 as the modulation source rather than LFO2.

ⓘ With so many hardwired filter modulations available, you won't need to use valuable Mod Matrix slots for the majority of routine filter modulation tasks.

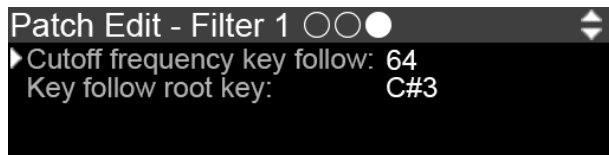

### Cutoff Frequency Key Follow

This parameter is only available in the Filter pages, it does not have a physical control. It controls the tracking amount of the filter. Filter tracking is a mechanism to match the filter to the frequency of the note being played so that the harmonic content of notes similar regardless of the note played.

### Key Follow Root Key

This parameter is only available in the Filter page, it does not have a physical control. Use the Root Key to assign the MIDI note that the filter frequency is tied to and the Key Follow Amount to adjust the slope (adjustment to the frequency by MIDI key) around that.

ⓘ In most cases, you can leave these controls at their default settings so that the filters track the MIDI key with a standard slope.

## Envelope Generator Controls

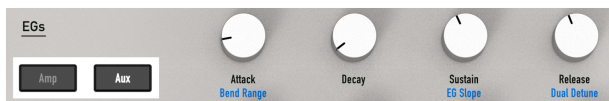

### Overview

Kyra provides three Envelope Generators (EGs).

- EG1 is dedicated to modulating the Amplifier.
- EG2 is dedicated to modulating the Filter
- EG3 is available for general modulation

All the Envelope Generator pages are part of the EG page sequence which is described in this section.

### Amp & Aux EG Select Buttons

The **Amp** and **Aux EG Select** buttons select which EG is configured by the four controls to the right of the buttons. The buttons are also useful for navigating to all three EG pages to inspect the parameter values.

! Use the **EG Amp** and **EG Aux** buttons to navigate to all three EGs easily. To select EG2 just press **EG Amp** select button twice.

### Attack

The Attack setting determines the attack rate for the selected EG. This is amount of time it takes for the EG output to go from zero to maximum level.

### Decay

The Decay setting determines the decay rate for the selected envelope generator. This is the amount of time it takes for the EG output to drop from maximum level to reach the Sustain level.

### Sustain

The Sustain setting determines the sustain level of the selected EG. This level is held so long as the note is held.

### Release

The Release setting determines the release rate for the selected EG. This is the amount of time it takes for the EG output to go from the sustain level to zero after the note is released.

## EG Controls in the Filters Section

EG2 is designed to provide filter modulation and has a dedicated set of controls. Despite being intended for filter modulation, you can use EG2 as a general purpose modulation source just like the other EGs.

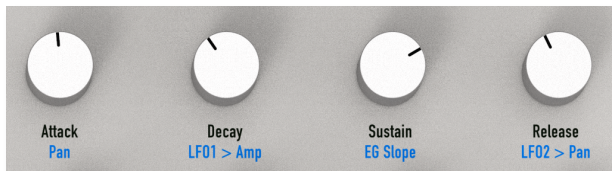

### Attack

The Attack setting determines the attack rate for EG2. This is amount of time it takes for the EG output to go from zero to maximum level.

### Decay

The Decay setting determines the decay rate for the EG2. This is the amount of time it takes for the EG output to drop from maximum level to reach the sustain level.

### Sustain

The Sustain setting determines the sustain level of EG2. This level is held so long as the note is held, unless a non-zero slope value is set.

### Release

The Release setting determines the release rate for EG2. This is the amount of time it takes for the EG output to go from the sustain level to zero after the note is released.

## Envelope Generator Pages

You can navigate to the page for any of the three EGs using the **EG Select** buttons, as described above. If Follow Mode is engaged, changing any EG control will switch to the relevant EG page.

All the EG pages are the same with the single exception EG1 doesn't offer the Bass Delay feature. The descriptions below otherwise relate to all three EGs.





### Attack

ⓘ Please see the description of the **Attack** control.

### Decay

ⓘ Please see the description of the **Decay** control.

### Sustain

ⓘ Please see the description of the **Sustain** control.

### Release

ⓘ Please see the description of the **Release** control.

### Slope

ⓘ You can adjust the **Slope** setting using the **Sustain** control with **Shift Mode** engaged.

This parameter controls the slope of the EG. Kyra's EGs build on the basic ADSR envelope format to include a Slope

parameter. This parameter adjusts the rate of change during the sustain period of an EG. Unlike the attack, decay and release transitions, the slope is linear. The default value of zero switches off the slope such that the EG outputs a constant sustain level so long as the note is held. Positive values will cause the EG sustain output to gradually increase and negative values will cause the sustain output to gradually decrease. Larger values, either positive or negative, cause an increase in the rate of the slope. At lower settings, the slope transition can be as long as 60 seconds.

### Bass Delay

ⓘ The Bass Delay feature is not available on EG1.

There's no physical control, the parameters are available on the EG2 and EG3 Bass Delay pages.

The purpose of EG Bass Delay is to delay the onset of a modulating EG (which is typically EG2 or EG3) relative to the onset of the amplifier EG, EG1. On certain Patches, without Bass Delay, it is possible for very fast EG modulation of parameters such as wavetable level or filter frequency) to be skewed relative to the onset of the note. The result of this is variation of the amount of modulation that is heard up to and including not being able to hear it at all. This occurs only at very low frequencies (typically those

used for basses) and is caused by Kyra's click suppressor delaying the signal for up to one wave cycle. At higher frequencies, this time is so short so as not to be important but at very low frequencies, it can be long enough such that the sound does not start until the modulation EG cycle is already underway, or if it's short enough, already completed.

To avoid this without increasing play latency, the Bass Delay feature slightly delays the onset of the modulating EG such that the sound has already started before the modulating EG starts. It is short enough to be barely noticeable for bass sounds but it's long enough to be certain the wave has started before triggering the modulating EG.

If you create a Patch with the following features, you should consider enabling Bass Delay to ensure a consistent modulation effect:

- The sound is very low frequency, typically a bass.
- The amplitude attack is extremely fast.
- The modulating attack is extremely fast.
- The modulating decay is short (less than 100mS)
- The modulation amount is very high (e.g. filter frequency or wavetable level used for 'bite').

If your Patch meets all these requirements, enable Bass Delay for the EG (2 or 3) that is being used for the attack

modulation. This will result in a consistent sound (some variation will remain, but it will be minimal). Note that on certain sounds it might not be possible to remove all variation. If the track you're recording requires identical beats, please consider sampling a note hit and using that in your DAW. If your song relies on very tight timing of the bassline, consider bringing the bassline forward very slightly to compensate for the slight delay added by Bass Delay.

For any other sound, ensure Bass Delay is switched off otherwise there'll be a slight pop or punch at the start of sounds with fast modulated attacks. This itself is an effect and you might find it useful. As always, experimentation is the key.



## Amplifier Controls

! The quickest way to navigate to the Amplifier Control page is to press the **EG1 Select** button and then the **Cursor Up** button.

### Limiter Curve

The Input Limiter has three selectable curves offering increasing levels of compression. Please refer to the section on Sound Programming for more information about Limiters and compression in general on Kyra.

! For most Patches, you can leave compression its default setting of Medium.

### Stereo Pan

This setting determines the Patch Pan position.

! You can adjust the **Stereo Pan** setting using the filter **EG2 Attack** control in the Filter section with Shift Mode engaged.

### LF01 to Amplifier

! You can adjust the **LF01 to Amplifier** setting using the filter **EG2 Decay** control in the Filter section with Shift Mode engaged.

This setting determines the amount of modulation of the amplifier (tremolo) by LF01.

### LF02 to Pan

! You can adjust the **LF02 to Pan** setting using the filter **EG2 Release** control in the Filter section with Shift Mode engaged.

This setting determines the amount of modulation of the pan position by LF02.

## LFO Controls



Kyra offers three Low-Frequency Oscillators (LFOs), all of which are identical except LFO3 does not have the Delay or Dual Antiphase/Quadrature feature. Each LFO can be used for modulation purposes and generates a periodic waveform with adjustable rate and shape.

The following sections briefly describe the function of the controls.

### LFO Select Buttons

Use the **LFO Select** buttons to select which LFO the **Shape** and **Rate/Delay** controls affect. You can also use the **LFO Select** buttons to navigate to the relevant LFO page for inspection of the parameters, the buttons light to indicate the LFO is selected. The LEDs above the buttons blink to indicate the rate of the LFO.

### Shape

The **Shape** control selects the basic LFO shape of the selected LFO. 128 shapes are available including basic sine, square, triangle and sample & hold (random) and other more complex shapes. A useful waveform diagram shows the LFO wave shape. With 128 shapes available, there's a lot of potential for creative modulation.

You can go beyond the 128 shapes available and achieve complex, evolving LFO waveforms by configuring frequency modulation (FM) on the LFOs by routing the output of one LFO to the LFO rate of any LFO including itself using the Mod Matrix.

### Rate

The **Rate** control sets the rate (frequency) of the selected LFO. If the LFO is configured for external sync via MIDI clock, this control does not have any effect (unless the MIDI clock is missing).

LFO Rate can be varied from 0.1 Hz to 12.8 Hz in 0.1 Hz steps. Kyra's LFOs can be accurately synchronised to MIDI clock. As mentioned above, the LEDs above the LFO Select buttons flash to indicate the LFO rate.

## LFO Pages

You can navigate to the LFO pages using the **LFO Select** buttons as described above. Additional LFO pages can then be reached by using the **Cursor** navigation buttons. If Follow Mode is engaged, changing an LFO control will switch the display to the relevant LFO page.

The main page for LFO1 is shown below. The pages and parameters for the other LFOs are similar (LFO3 does not have Delay or stereo settings).

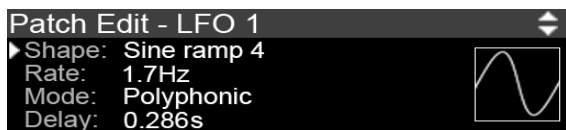

### Shape

ⓘ Please see the description of the **Shape** control.

### Rate

ⓘ Please see the description of the **Rate** control.

## Mode

The Mode setting controls how the LFO operates. These modes add considerable flexibility to the use of the LFOs so take some time to understand the options:

**Monophonic** - the LFO runs freely and with no regard to note events. This is the default and suitable for modulations that should always be in phase and apply to all notes on the Part.

**Polyphonic** - the LFO phase applied to a new note is reset when the note starts and thus the LFO phase can be different for each note played. This, in effect, turns the LFO into a repeating mini-EG.

**Random Phase** - the LFO phase is set to a random value when the note starts so that the LFO phase will be different for each note played. This is useful for adding movement to pads and string ensembles when applied to parameters such as pitch, pulse width, amplitude (tremolo) or pan.



A small amount of delay on the LFO will remove any attack clicks that can occur when an LFO starts at non-zero phase in Random Phase mode.

**Dual Antiphase** - The LFO runs freely (Monophonic) but when Kyra is in Dual Mode, the LFO output is inverted (antiphase, 180 degrees out of phase) on the second voice.

The Patch must be in Dual Mode for this setting to work, otherwise it will operate as per Monophonic. This option is not available for LFO3.

**Dual Quadrature** – As with Dual antiphase but the LFO outputs run in quadrature (90 degrees out of phase). The Patch must be in Dual Mode for this setting to work, otherwise it will operate as per Monophonic. This option is not available for LFO3.

As Dual Mode configurations are inherently stereo, the dual LFO settings can produce stunning stereo effects when applied to destinations such as pitch, pulse width, hypersaw spread, pan or the filters (even if Dual Filter Mode is not enabled).

! Dual Mode must be selected for the Dual (stereo) LFO modes to be effective.



Be sure to make good use of Kyra's stereo LFOs. You can achieve some wonderful animated stereo effects with Kyra's advanced LFO modes.

### Delay

This setting determines the ramp-up delay period of the LFO. A value of zero means there is no delay, higher values will result in a longer ramp-up time. This parameter is not available for LFO3.

### Clock

The Clock setting configures the timebase for the LFO. When set to Internal, the LFO operates using the rate configured with the LFO's Rate control. The MIDI settings synchronise the LFO to an incoming MIDI Clock signal with the configured beat division. MIDI clock must be enabled on your master device (typically a sequencer/DAW) for this to work. Check the settings for your sequencer – MIDI clock is usually off by default.



Before selecting a MIDI clock option for an LFO, ensure MIDI clock is configured in the MIDI Configuration pages by selecting the correct MIDI port (USB or MIDI) to match the source of the MIDI clock. If for any reason the LFO does not detect a valid MIDI clock when it is configured to use MIDI clock, the LFO will run at its configured rate instead.

## Mod Matrix Controls

### Overview

The Mod Matrix Select button provides quick access Kyra's Mod Matrix (Modulation Matrix) functions. Each press on the Mod Matrix **Select** button moves to the next Mod Matrix channel (there are six channels available). The LEDs above the **Select** button indicate which of the six Mod Matrix channels are in use in the current Patch.



Kyra offers a wide range of modulation sources and destinations. The connection between a modulator and a destination is called a route. Kyra offers many preset modulation routes (called hardwired routes) and these are typically the most used ones. As an example, the Oscillator Groups offer a LFO1 to Pitch as a hardwired modulation route. Use the hard modulators if they serve the purpose you require. If you need more flexibility, look to the Mod Matrix. You can use the hardwired routes and Mod Matrix in any combination you wish, the permutations are virtually limitless.

To use the Mod Matrix effectively, you should be aware of the distinction between **monophonic** (channel or per Part) and **polyphonic** (per note) agents.

! An agent is any of the sources or destinations that participate in the Mod Matrix.

In the case of sources, a monophonic source is a source that is generated at the channel level. Typical examples of a monophonic source would be channel aftertouch or the mod wheel. There is only one and you would expect it to apply to all notes on the channel.

On the other hand, a polyphonic source is one that is specific to a note. The most obvious examples of this are velocity and polyphonic pressure. Each note has its own velocity and you would reasonably expect that velocity to only apply to that specific note.

A source is either monophonic or polyphonic. The exception is the three LFOs - LFOs are both monophonic and polyphonic - when applied to a polyphonic destination, they provide polyphonic modulation. When applied to a monophonic destination, they provide monophonic modulation (specifically, per-note phasing is not applied).

The same concept applies to destinations. There are monophonic destinations such as the effects module param-

ters. There is only one Effects Unit per Part and therefore it applies to all notes on that Part, not specific notes.

On the other hand, a polyphonic destination is one that is specific to a note. An obvious example would be filter cutoff frequency. As would be expected of any polyphonic synthesizer, Kyra has a filter for each voice and it is reasonable to assume modulation would be per note.

At first glance, only a monophonic source should modulate a monophonic destination and only a polyphonic source should modify a polyphonic destination. But that would be overly and unnecessarily restrictive. Consider a situation where you would route channel pressure (aftertouch) AND an envelope generator to filter cutoff. It is a common configuration and it is reasonable to expect it to work. Each note would have a 'twang' from the envelope generator modulation but all notes would take a basic cutoff frequency from the channel pressure - so as you push down on the keybed, all the notes twang brighter. In this situation you have both a monophonic (channel level) modulator and a polyphonic (per note) modulator routed to a polyphonic destination.

This makes sense and Kyra supports it. What would not make sense is to route a polyphonic source to a monophonic destination. For example, consider the example of routing velocity to the wet/dry mix of an effects module. What would it do if you played a three-note chord? It

would route three different modulation values to the single effects module which would not do anything useful and probably cause a glitch. Note that LFOs are also classified as monophonic destinations - they can have a different phase for each note but all the other parameters such as rate and shape are common for all notes on the Part.

For this reason, Kyra does not support routing polyphonic sources to monophonic destinations but it does support routing monophonic sources to monophonic and polyphonic destinations. Remember that LFOs can be applied as monophonic and polyphonic sources, simultaneously, and they will adapt to the destination selected.

If you configure any of these unsupported combinations, they will have no effect.

To assist you in making valid routings, small icons are displayed on the Mod Matrix pages (the pages where you select the sources and destinations). These remind you what the type of each agent is. For sources, a 'P' badge indicates a polyphonic source. All destinations are polyphonic except those related to LFOs and Part effects.

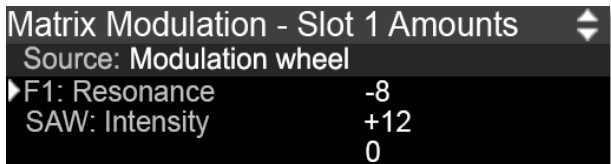
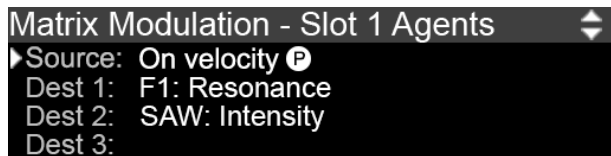

### The Random per Note Source

Random per note is a useful source that generates a random value on each note event on the Part. It is very useful for 'humanizing' sounds as it allows you to apply a slight, random per-note detuning and other variations per note as would be typical with traditional musical instruments.

 Random per Note is useful for making tracks sound less mechanical.

### MIDI Note Number Source

This source is a value that represents the MIDI note played. Use it to modulate parameters over the range of the keyboard. One particularly useful application is to route it to Pan. With the right settings and configuration of the Pan control itself, it allows you to spread an instrument out over the stereo field depending on the note played. Consider a stereo miked grand piano - on certain recordings it is possible, owing to the size of the instrument, to hear the notes move across the stereo field depending on the note played. This routing allows you to emulate that. Other uses would include reducing decay and release times for higher notes on a piano and reducing the level of higher notes to balance out resonant effects. The source can also be used to achieve unusual key tunings (including fixing pitch across the keyboard), although microtuning is the best way to achieve accurate key tuning variations.

### Generic MIDI Controller Sources

In the modulation sources, you'll see generic MIDI controller sources marked as 'MIDI controller #n'. These are sources available for you to use as you wish. Most DAWs allow you to 'paint' in controllers and many master keyboards allow you to assign MIDI controllers to its front panel controls. Use these sources to take advantage of this.

The number following the hash/pound is the actual MIDI controller value to use in your DAW or master keyboard.

Most DAWs will allow you to paint in other MIDI modulators such as polyphonic pressure so you can use these resources even if your keyboard doesn't support them directly.



Use the MIDI CC# inputs to the Mod Matrix to enable your DAW or master keyboard to modulate just about any parameter on Kyra.



## Effects Controls

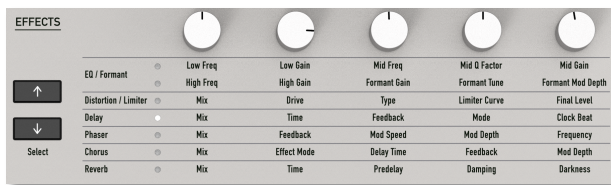

Kyra has comprehensive Effects (FX) Unit on each of its eight Parts. The Effects Unit comprises nine stereo effects modules. The function of the five controls in the Effects group depend on which of the Effects Modules is selected (some modules share a selection).

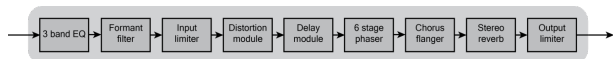

### Effects Select Buttons

The **Effects Select** buttons selects each of the Effects Modules in turn. The function of the five rotary controls in the Effects section are determined by which Effects Module is selected. The selection wraps round so you're never more than four button pushes away from the effect you want to inspect or change.

## Effects Controls

The controls cover most, but not all, of the parameters for each of the Effects Modules. A few additional parameters are available in the effects pages and can be adjusted using the **Value** buttons when selected. To locate these parameters, use the **Effects Select** buttons to select the effect and then locate the parameter with the **Parameter Up/Down** buttons. You can then use the **Value** buttons to change the parameter.

The Effects Unit provides considerable opportunity to shape and process the final sound coming from each Part ready for final output. Live musicians can use the effects to provide ready-to-play, straight into the amp/board sounds without the need for outboard and studio musicians can similarly use the effects to achieve live-feel, mix-ready sounds without outboard effects or tying up their DAW with effects plug-ins. The USB audio streams and multiple outputs allow the best of both worlds in that you can freely choose between internal and outboard effects as you wish.

Effects are an integral part of a Patch. Therefore, each Patch can have its own effects configuration and will always sound the same regardless of which Part the Patch is loaded into. With 9 effect modules on each of the 8 Parts, you have no less than 72 modules available simultaneously.

Most of the parameters for the effects can be controlled via the Mod Matrix. This opens a wide range of possibilities.

Top class outboard effects and plug ins will have more options than the built-in effects so on occasion it can make sense to use a combination of internal and outboard units.

To help with setups like this, you can selectively defeat (bypass) the internal effects on a per-Part basis, so you can apply outboard effects without having to modify Patches. For example, you could dedicate one or more of Kyra's stereo outputs to be effects sends and route any Parts due for outboard effects to those outputs. Then you disable the effects you're going to do outboard in the Part configuration (e.g. defeat the reverb but retain the DDL) of the Parts routed to the output. Once a Part is configured as described, any Patch loaded into that Part will have its DDL enabled (if enabled in the Patch) but any reverb in the Patch will be defeated and sent out of the effects send outputs 'dry'. This configuration can then be saved as a Multi, so you can instantly recall it and have variations you can switch between quickly.

### Configuration

Each of Kyra's effects modules can be individually configured and defeated (bypassed). However, the ordering of the

effects is fixed and can't be changed. Many effect parameters are available as destinations in the Modulation Matrix.

Kyra's comprehensive Effects Unit allows the synthesizer to produce mixes ready for final mastering straight from the output jacks or a mixing desk. This saves time and valuable processor load on your DAW and/or the need for outboard hardware effects. However, should you wish to use outboard or plug-in effects for one or more Parts, Kyra offers total flexibility either via by using the line outputs connections as effects sends or via USB direct to your DAW with selectable per-Part effects defeats provided.



Advanced users can use the Part Effects defeats and multiple outputs (line or USB) to configure outboard effects supplement or replace Kyra's effects as required.

### Performance

With Kyra you don't have to worry about 'Processor Load'. Effects on Kyra are performed by dedicated resources and will never affect the performance of the synthesizer regardless of the number of effects you select or the settings of those effects. So, if you want a subtle chorus on a Part along with a ten second reverb and some EQ adjustments, just go ahead. You can use all 72 of the effects modules

across all eight Parts and there will never be any impact on performance, polyphony or sound quality.

As Kyra's effects have no impact on performance, you'll find there's novel ways you can use some of the effects. A very short ping-pong delay with some feedback on the DDL can give extra space and dimension to a sound without tying up the chorus/flanger module as a doubler. The phaser can be used to generate artificial colouration and faux stereo effects and the chorus/flanger effect can serve up a very wide range of sounds from subtle chorus and slap-back delay to wild flangers.



With effects, sometimes, less is more !

### Shelving EQ Module

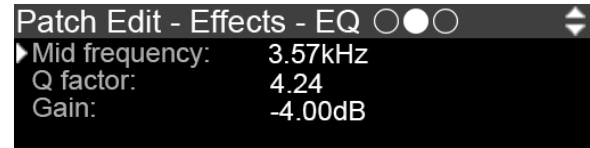
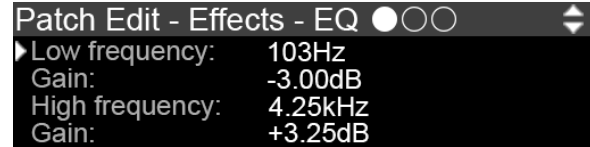

The first effect in the Kyra's Effects Unit is the EQ. The module provides a 3-band shelving EQ with sweepable mid. Use the EQ to shape the sound by boosting or attenuating (cutting) certain frequency ranges. The EQ provides a useful supplement to the Filter whereby, for example, the latter can leave a sound with a little less bass (e.g. in the 4-pole 24dB configurations) or too much top end, you can use the EQ to correct that. The sweepable mid is ideal for reducing unwanted peaks from a sound.

The EQ module offers up to 16dB of cut or boost on each of the three bands but note if you find yourself needing much more than 3 or 4dB of cut or boost, it might be worth revisiting the settings of the Patch itself. It is better to cut

unwanted frequencies rather than to boost the rest. Plan your use of the EQ carefully so you know what you're looking to achieve from the settings. One example is to not add high frequency boost to a sound with little high frequency content (e.g. a deep pad). This will only serve to add unwanted noise to the sound – it might be a better plan to open the filter slightly instead.



Avoid unnecessary boosting of frequencies that are missing by design in the signal.

Bear in mind that excessive boosting can easily result in distortion in the Limiters. Keep a close eye on the boost levels in use as well as the overall levels of the Patch; if you do use significant boost in the EQ module, remember to reduce the level of the Patch so that there is headroom for the peaks otherwise there is a risk of limiter compression - this may or may not be desirable depending on the sounds you're trying to achieve.

The lower and upper shelves can be adjusted over several octaves of the lower and upper parts of the audio range and the mid can be swept over the full audio range, including an overlap of the shelves. The Mid also has a Q-factor setting - higher values make the cut or boost more selective (narrower).

To bypass individual EQ bands, simply set the relevant gain control to zero. Setting all three bands to have zero gain effectively bypasses the effect completely..

Some of the EQ parameters can be modulated from the Mod Matrix but note that they are intended to be static (i.e. set from a MIDI CC at various points during a song or modulated very gradually). Unfortunately, the EQ parameters do not have enough resolution to be modulated continuously and you may hear stepping if you attempt it.

### Formant Filter

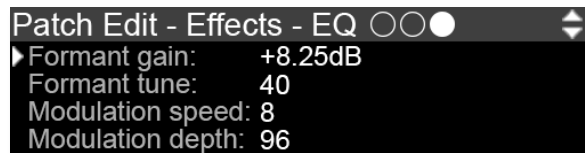

The Formant Filter offers a similar range of gain for the formant pair configured by the formant **Tune** control. There is no cut option for the Formant Filter and the Q factor is preset to a relatively high (selective) amount to clearly emphasise the vocal formants. The two frequencies are chosen to model the human voice and are adjusted according to an algorithm controlled using the Tune control. Increase the formant level to boost the intensity of the

formant effect. Many sounds will take on distinctive vocal characteristics as the formant gain control is increased. The Formant Filter is particularly effective for choral pad sounds but can also be used for short percussive sounds. For convenience, the Formant Filter has a dedicated LFO for basic formant modulation effects. If more advanced modulation is required, consider LFO or MIDI CC automation via the Mod Matrix. The Formant Filter LFO controls can only be adjusted using the **Value** buttons, no physical control is available for the LFO parameters.

### Distortion Module

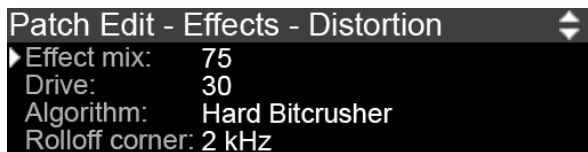

The Distortion module can add effects to the Part's sound ranging from a subtle harmonic edge to almost complete destruction of the signal.

The Distortion module currently has five distortion algorithms: Soft Rectifier, Hard Rectifier, Bit Crusher I, Bit Crusher II and Gnasher. Each has a very distinctive effect. The 'hard' variants are more severe versions of the 'soft'

variants. The rectifiers add traditional harmonic distortion, the bit crushers add a gritty lo-fi effect to the sound and the Gnasher is a band-limited tube limiter/compressor model. Gnasher is unique amongst Kyra's distortion algorithms in leaving low level signals undistorted, so it is very useful for longer pad-type sounds.

To apply Distortion, increase the Distortion **Effect Mix** control. This will increase the amount of distorted signal in the signal chain. At the lowest setting, the Distortion module is effectively bypassed. At the maximum setting, the signal is sourced entirely from the Distortion module. Use intermediate settings to blend between the two.

The Drive parameter adjusts the signal level going into the Distortion module itself - at lower settings, the input signal is attenuated, at higher settings the signal is boosted. As the Distortion module will add significant gain and compression to the overall signal, the **Final Level** control should be used to equalize the overall Part level so that it is comparable to other Parts. The **Final Level** control has the same effect as the **Part Level** control but is stored as part of the Patch itself. Both level settings are accounted for when setting the overall level of the Part relative to all the other Parts. The Final Level control should be left at its default maximum setting (minimum attenuation) unless the Patch is too loud relative to other Patches and you don't want to reduce the pre-effects Patch

Level. If that is the case, reduce the **Final Level** control to equalize the Patch level without affecting the timbre (recall that the **Final Level** control, unlike the Patch Level, is post-effects). If a Patch is causing excessive Limiter compression even without the Distortion module active, adjust the Patch Level (pre-effects) to address this, not the Final Level.

The Rolloff Corner setting adjusts the frequency of a low-pass filter located after the Distortion Module (on the wet path only). This single pole (6dB/octave) filter is ideal for taking the bright edge off the distortion which might otherwise be overpowering, depending on the sound being generated. Use lower settings (lower cutoff frequencies) to attenuate the higher frequency components from the distortion. Note that the Distortion Module filter only filters the wet signal, not the overall mixed signal. As a result, if the Distortion Module is bypassed (the mix is set to completely dry), the filter will have no effect.

### Limiter Modules

Kyra has two limiters on each Part. The Limiters provide dynamics control for the Part. The first limiter, the Input Limiter, is located after the Distortion module in the effects chain. The second limiter, the Output Limiter, is located at the end of the effects chain just before the Output Mixer. Both Limiters work together to manage the potentially

massive dynamic range of signals coming from Kyra's sound sources and effects unit.

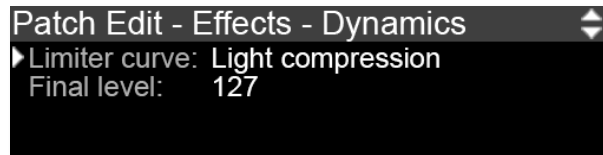

Both Limiters model classic valve (tube) amplifiers such that increasing signal levels result in compression and additional harmonics. If you want a clean signal with no obvious saturation effects, be sure to keep the Patch level low enough so that there is plenty of headroom for the loudest passages (typically those with the most notes played at the highest velocities) and use lighter limiter curves (e.g. light or medium). There are no hard and fast rules here but as you get used to how Kyra works, you'll get a feel for it. Remember it's not just the overall perceived loudness of the signal, a sound that doesn't sound 'loud' can have peaky harmonics that cause limiting to occur. The key is to keep Patch levels under control and keep a special eye on features that can inadvertently cause large increases in levels such as resonant filters, EQ boosts, high Formant Filter gains and feedback in effects modules. Dual Mode and Hypersaw Mode configurations also result in significantly higher overall levels.



Advanced users may wish to keep compression levels at a minimum and apply it in their DAW during the mastering phase of their project. With a 32-bit signal path and DACs, Kyra allows operation with low levels and compression without a significant loss of quality.

In some cases, the effect of the Limiters is desirable and you may wish to deliberately boost the Patch level to induce significant saturation and compression. You can achieve wonderful, raucous tube amplifier effects of electric piano and guitar-style Patches this way, especially when combined with the Distortion module. Use higher levels and Limiter intensity settings to emphasise the effect. As always, the key is to experiment and let your ears guide you. You can use the Part level to re-balance the overall Part level after the Patch level has been set to the level that achieves the distortion (or lack of distortion) required.

The Input Limiter has three selectable curves offering increasing levels of compression but note compression is not the same as a volume control; the Input Limiter curve setting should not be used to adjust the volume of the Patch. The Output Limiter has a fixed configuration and manages any gain that occurs in the effects chain.

If you find that the sound is over-saturating, look to reduce the Patch level and restore the overall level using the Patch Final Volume. Heavy use of the Distortion module will result in saturation when the signal is louder (e.g. several notes are played).

### Digital Delay Module

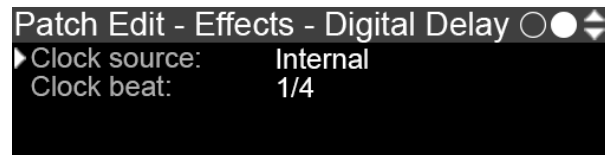
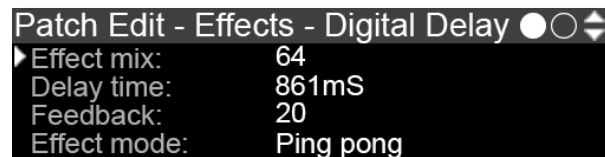

Kyra's Digital Delay module fulfils the role of the classic Digital Delay Line (DDL). Kyra has a stereo Delay module on each Part, each offering a generous delay time of up to 2.7 seconds. The Delay module can be used to provide effects ranging from simple doubling all the way up to stereo phrase-based delay effects.

The Delay module allows feedback varying from zero (no repeats) up to unity (infinite repeats). Like a tape delay, there is a slight roll-off of higher frequencies in the feedback loop although this is only noticeable if the delay time is short and the feedback is very high.

The Delay module can be configured for regular stereo delay or ping-pong mode. In ping-pong mode, the repeats will alternate between the right and left outputs as the feedback paths are swapped. Ping pong delay is particularly useful if the original sound is panned to the left as the echoes are then balanced. It can also be useful for choral strings and pads as it can generate multiple 'surround' echoes to add depth to the sound and supplement the early reflections of the Reverb module. Another use for ping-pong mode is to add a faux stereo effect - select a very short delay setting of 2 or 3 and moderate amounts of feedback. Increase the dry/wet mix and feedback amount until a pleasing stereo effect is heard. This is a great way to add stereo width to a sound without resorting to Dual Mode configurations.

The dry/wet **Mix** control allows the intensity of the delay to be adjusted from completely dry (effect bypassed) to equal dry/wet mix (50% wet). Note that unlike the other effects, the **Mix** control on the delay module ranges between 0 and 50% wet rather than 100%. The most

useful range is around 10-30 which offers a natural balance between the initial sound and the echoes.

The Delay module can be synchronised to the tempo of your song by means of MIDI clock synchronisation. When the Delay module is configured to synchronise to MIDI clock, a beat setting is available to adjust the ratio of the delay value to MIDI clock. The Delay module can also be locked to the timing of LFO3 (even if LFO3 is itself set to external clock), again, the beat setting is available to adjust the ratio of the LFO timing to the beat. When the DDL is set to MIDI clock and a MIDI clock is present on the MIDI port configured for MIDI clock, the **Delay Time** control will have no effect until the clock is stopped or the clock source is set to Internal. As the **Delay Time** control is quite coarse so that it can cover a wide range of delays, if you need precise tempo matching, use MIDI clock synchronisation to achieve accurate sync.

The **Delay Time** control will cause considerable pitch distortion if it is changed (whether it is changed manually, by Mod Matrix modulation or by a MIDI clock change) whilst there is audio in the delay module. The resulting sound is very much like the scratch effects made popular in early rap music and with long or infinite feedback can be a useful standalone effect - try modulating the delay time with an LFO routing. If this effect is not desired, it is best not to change the delay time setting when audio is playing



on the Part. The Delay module does not offer direct modulated delay effects, use the separate Chorus/Flanger module to achieve modulated delay effects such as vibrato, chorus and flanging.

### Phaser Module

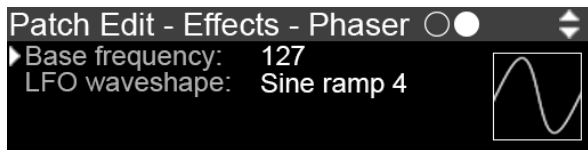
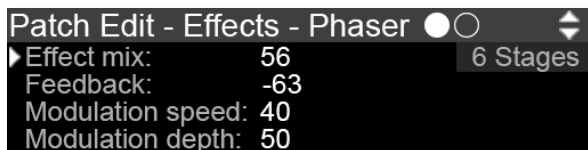

Kyra features a hand-crafted 6-stage stereo Phaser on each part and the effect includes a dedicated dual-output (quadrature) super low frequency LFO with the same waveshapes available in the main LFOs. Further modulation possibilities exist with the Mod Matrix.

Use the Phaser to provide the classic swirling phaser sound. Alternatively, you can use the Phaser with little or

no modulation to provide sound colouring to emulate instrument resonances. Several of the Kyra presets use the Phaser in this configuration to provide a colouration and boxy faux stereo effect. In this configuration use the Phaser's frequency control to choose the colouration required. The Phaser is also very useful for vocal effects and works well with the Formant Filter. Check out some of the vocal preset Patches - many have the Phaser frequency wired up to the modulation wheel to adjust the timbre of the effect.

The **Feedback** control determines the intensity of the effect. The feedback can be positive or negative and the effect is very different in each case. With positive feedback the sound has distinctly less bass as there is attenuation at low frequencies but the effect is more intense and very distinct from negative feedback.

The **Mix** control allows the effect to be mixed in from 0% (i.e. no effect) to 100% wet.

Kyra's Phaser has a dedicated super-low frequency stereo quadrature LFO. In contrast to the main LFOs, the Phaser LFO runs at one tenth of the speed to allow for Phaser sweeps that can span over several bars. By default, the modulation waveform is a sine wave but the Phaser LFO allows any of the main LFO shapes to be selected as an alternative.

Note that the built-in LFO is always applied as a stereo quadrature pair whereas any modulation of the Phaser frequency via the Mod Matrix will always be in-phase mono. Both have a distinctly different sound and you can use both together to get some very interesting effects. Note that the built-in Phaser LFO does not have a MIDI sync feature – if you need Phaser modulation that is in sync to your song, modulate the Phaser frequency with one of the main LFOs via the Mod Matrix.

Keep a close eye on levels when using large amounts of Phaser feedback, especially when combined with resonant filter settings otherwise the Output Limiter will kick in to constrain the peaks. If you are getting resonant peaks that mean the overall Patch level is too low, you may wish to reduce the feedback or filter resonance to regain control of the peaks.

### Chorus/Flanger Module

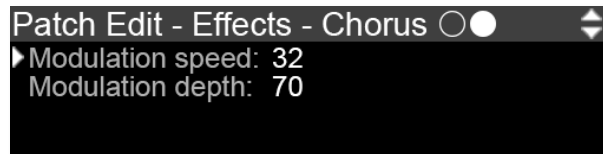
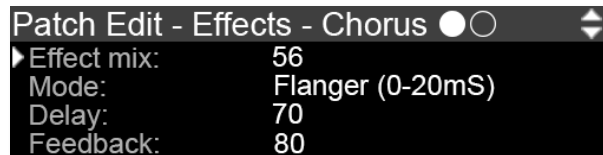

Kyra's Chorus/Flanger module is very versatile. It is able to deliver a range of effects including those associated with comb filters, chorus units, flangers, doublers and slap-back delays. As with all the effects modules, Kyra has a Chorus/Flanger module on each Part and each module has a dedicated dual output (quadrature) LFO to provide modulation effects.

Experience and your ears will soon guide you with the best configuration for the Chorus/Flanger module but be sure to check out the preset Patches for some examples. As a programming note, be aware that as a delay effect, high

levels of Chorus/Flanger settings can slightly round the percussive start to fast attack sounds. If you want the utmost in fast attack sounds, keep the mix levels and delay times used in the module low or consider using the Phaser instead as Phasers are not delay-based effects. Similarly, if you want to avoid pitch variation on very pure sounds such as pianos, consider reducing or removing Chorus/Flanger modulation (speed and intensity) as well as reducing the feedback and delay time.

Keep an eye on levels when using large amounts of Chorus/Flanger feedback (e.g. over 80) when configured for flanger or comb type effects, especially when combined with resonant filter settings. Large peaks will cause the Output Limiter to kick in. If this effect is undesirable, reduce Patch level or alternatively, reduce the feedback level.

The **Mix** control allows the effect to be mixed in from 0% (i.e. no effect) to 100% wet.

### Reverberation Module

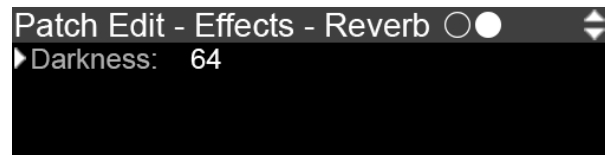
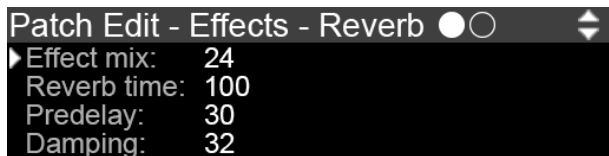

Kyra features a Reverb module on each Part offering reverberation times up to about 20 seconds. The Reverb module does not have presets like many standalone units do but many of the classic reverb parameters are supported such that the sound of many classic reverbs can be configured.

The Reverb module features a pre-delay unit providing up to one second of delay. Pre-delay extends the delay between the initial sound (early reflections) and the main reverb tail and is useful to give the sound some space. The pre-delay can also achieve sounds like a gated reverb.

The two coloration controls, **Darkness** and **Damping** have similar but subtly different effects. Darkness is implemented as a low pass filter on the wet-path input to the reverb. Increasing the Darkness value removes higher frequencies giving the reverb a deeper, darker tone. On the other hand, Damping is a similar low pass filter but is in the reverb's feedback loop. As such the reverb tail will be 'damped' (lose high frequencies over time) according to the setting

of the Damping control. Note that at extremely high Darkness settings the reverb sound may disappear completely as the filter removes almost all the signal and just a rumble may remain, assuming there was any low frequency present in the original signal to start with.

As with any effect, the key to achieving a clean sound is correct configuration and in the case of reverb, too much is rarely a good thing. If you find the reverb is dominating the sound or the Part appears slushy or muddy in the mix, look to reduce the dry/wet mix and reverb time and/or increase the Damping and Darkness, especially if the domination is in the higher frequency ranges.



Remember, sometimes, less is more !

The pre-delay feature can be used to give percussive sounds some space.



Advanced users may wish to use the Part reverb defeats and apply reverb in their DAW during the mastering phase of their project. The defeats allow removal of onboard effects without having to modify Patches.

The **Mix** control allows the reverberation effect to be mixed in from 0% (i.e. no effect) to 100% wet.

## Arpeggiator Controls

Kyra features a Arpeggiator on each of its eight Parts. Arpeggiators process notes from your keyboard and play them in a sequence with a configurable rhythm and beat.

Arpeggiators are primarily for live performance but can be used with compositions too.

Kyra's Arpeggiator is an integral part of the Patch so the settings for the Arpeggiator and stored along with it even if the Arpeggiator is disabled. Therefore, it is not necessary to manually configure the Arpeggiator when a Patch is selected.

It is possible (but unusual) to have multiple arpeggiators as each Part has its own arpeggiator - synchronisation (either by manually matching the tempos or using MIDI clock) is needed for this to be useful though.



⏏⏏ Arpeggiators work best with sharp, percussive sounds. Review some of Kyra's preset sounds that feature the Arpeggiator (the Category Filter is useful for finding them) and experiment with different sounds to understand its abilities.

Keyboard velocity is not used by the Arpeggiator - the accent given to each beat played is defined by the selected arpeggio pattern.

⏏⏏ The sustain (hold) pedal is exceptionally useful for playing live arpeggios. Its function changes when the Arpeggiator is enabled - it serves to hold the arpeggiated notes rather than the individual notes the arpeggiator produces. This allows you to move easily between block chords without affecting the arpeggio timing (the Arpeggiator is reset when all keys are lifted).

### Enable Button

The **Enable** button activates or deactivates the Arpeggiator for the current Part. Once the Arpeggiator is activated, any notes (typically chords) played will play as an arpeggio. Timing is maintained so long as at least one note is held (by keeping at least one note down or by using the sustain pedal). When all notes are released, the Arpeggia-

tor is reset so that a downbeat will occur the next time a note is played.

The **Arpeggiator Enable** button blinks in time to the beat when the arpeggiator is activated. Note that the LED indicates the actual beat rather than just the basic tempo - only beats that are present will be indicated, if there is a rest, the LED will remain off for that beat.

Any notes playing when the Arpeggiator is activated will be released. Play new chords once the Arpeggiator is activated to start the sequence.

Note that if the Arpeggiator time source is set to MIDI, a MIDI clock must be present for the Arpeggiator to start, it will not 'free run' like an LFO does. Kyra will respond to MIDI start, stop and continue messages to ensure the beat is synchronised to your DAW even if you stop and restart playback mid song (even mid bar). When using the MIDI time source, ensure your controller or DAW is configured to send MIDI clock along with song start, stop and continue messages and that MIDI clock is configured correctly in the MIDI configuration page.

❗ If the Arpeggiator is configured for MIDI clock sync, it will not start until it receives a MIDI start or continue command. If the Arpeggiator is not starting, check the MIDI sync setting is as expected.

### Mode

The **Mode** button selects between the five operating modes of the Arpeggiator:

**Up:** Notes are played in order from lowest to highest

**Down:** Notes are played in order from highest to lowest

**Up+Down:** Notes are played in order from lowest to highest and then back to the lowest. The LEDs indicate Up+Down by the Up and Down LED being on.

**Chord:** All the notes are played at the same time (as if the chord was played repeatedly)

**Random:** Notes are played in a random order

### Range

The **Range** button selects the range over which the Arpeggiator operates. When in the default one octave range, only the notes played appear in the sequence. When a higher range is selected, notes from one or two octaves above the notes played will also appear in the sequence. The operation of the range control depends on the arpeggiator mode:

**Up:** Notes are played in sequence plus one or two additional octaves above the notes played on the keyboard. The sequence starts at the lowest note played.

**Down:** Notes are played in sequence plus one or two additional octaves above the notes played on the keyboard. The sequence starts at the highest note played plus zero, one or two octaves.

**Up+Down:** The sequence plays as per the Up sequence followed by the Down sequence. The notes at each end are only played once per sequence.

**Chord:** When the octave range is 2 or 3 octaves, the Arpeggiator will choose the octave of each note (not the whole chord) at random from the base octave played and one or two octaves above, depending on the setting of the Range control. This results in some very interesting sounds and is worth a try.

**Random:** Notes are played in a random order and a random octave (one or two octaves above the played notes depending on the setting of the **Range** control). Adding a range to a random arpeggiation results in a very interesting effect as notes played are selected randomly from the entire range.

### Tempo

The **Tempo** control adjusts the rate of the Arpeggiator BPM (beats per minute) from 58 to 185. It has no effect if the Arpeggiator time source is set to MIDI. If you require

tempos outside this range, please adjust the **Beat** parameter.

❗ If you need more accurate control of the Arpeggiator tempo, use MIDI clock sync from your DAW, drum machine or master keyboard.

### Arpeggiator Pages

The Arpeggiator page is presented when Follow mode is activated and any Arpeggiator control is moved. Keep in mind that most of the parameters that are shown on the arpeggiator pages are also available as physical controls.

❗ The fastest way to navigate to the Arpeggiator page is to press the **Arpeggiator Enable** button twice.



### Active

❗ Please see the description of the Arpeggiator **Enable** button.

## Mode

⚠ Please see the description of the Arpeggiator **Mode** button.

## Range

⚠ Please see the description of the Arpeggiator **Range** button.

## Pattern

The Pattern setting select the preset pattern the Arpeggiator will use. Pattern zero is a basic pattern with no accents or rests but other patterns will have different beats and accents. Pattern 127 is a special pattern that applies a random velocity to each beat (the random values are calculated in real time, so the pattern does not repeat).



Kyra's arpeggiator patterns are preset and intended for live performances. Whilst there's a lot of them, advanced users may prefer to use their DAW/sequencer for more complex arpeggio programming tasks such as those using unusual time signatures.

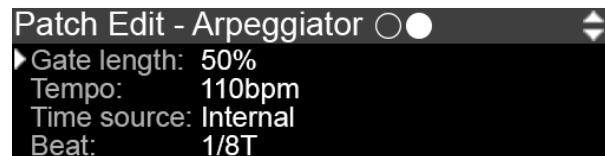

## Gate Length

This setting configures the length of the notes the arpeggiator plays and is relative to the configured tempo. At lower settings, the gate length (the time the "key" is active) is very short (staccato). At higher settings, the gate length approaches the length of one beat at the configured tempo (so notes without any rest will play legato). The value is shown as a percentage (of the beat time).

The effect of **Gate Length** is very much dependent on the envelope settings of the Patch. Depending on the settings, there may be little or no sound or Gate Length will have no obvious effect.

## Tempo

⚠ Please see the description of the Arpeggiator **Tempo** control.

## Time Source



This setting configures where the Arpeggiator gets its timebase from. If set to Internal, the Arpeggiator uses the value set for the Tempo parameter. If set to MIDI, the Arpeggiator uses an incoming MIDI Clock signal for synchronisation. Remember that Kyra requires a MIDI start/continue command to start the Arpeggiator when it is configured to use MIDI clock.

### **Beat**

The **Beat** setting determines the time division for the Arpeggiator tempo when using MIDI clock as a timebase.

Use **Beat** to select the ratio between the MIDI clock and the actual Arpeggiator beat as you require. This effectively configures the number of beats per bar whilst ensuring the Arpeggiator is always synchronized to the song tempo.

# Parts and Multis

## Overview

A Part is one of the eight fundamental resource units on Kyra. A simple way of thinking of a Part is that it is a complete synthesizer in itself; it has a MIDI channel, a sound configuration (a Patch), effects and an output. In that respect, Parts are completely independent and can be considered self-contained synthesizers. Instruments with multiple Parts are referred to as being multitimbral as they can play different sounds at the same time.

At its most basic level, a Part is simply a loaded Patch. Without any additional features that would be useful but impractical as to play more than one Patch at a time, you would most likely want to adjust a few things to get them to sound right together. For example, you may want to adjust the levels, stereo positioning etc. You could do that by editing the Patches but that would be tedious. The solution to that is the provision of another set of parameters outside of the Patch and they are the Part Parameters.

On Kyra, a Part does not exist in isolation, it always has seven siblings giving a total of eight. Together, the family of eight Parts is referred to as a Multi and represent the complete performance configuration of the synthesizer. Kyra supports storing 128 Multis. Changing the Multi reconfigu-

res the eight Parts simultaneously thus completely reconfiguring the synthesizer ready for performance (whether live or from a DAW).

So, think of a Part as a Patch combined with some additional Parameters that together, make a playable configuration. It's worth remembering a Part has a reference to a Patch but does not contain it (i.e. it does not take a copy of it). So when using Patches in various Multis, it makes sense to make a note of where the Patches are used so that if you change the Patches later, you are not making unintentional changes to another Multi; you can always copy a Patch if you think you may need to share it across Multis with later variations.

Multis are useful for both live and studio applications. For live performance, Multis are useful for layers and splits. Layering is the technique of placing two or more Patches together on the same MIDI channel to achieve truly wonderful sounds. Splitting is the technique of placing two or more Patches split such that one Patch sounds for a given range of keys on the keyboard, for example, a bass sound for the left hand and a lead sound for the right hand.

For studio applications, Multis are useful for grouping Patches together for instant recall for a song. A song can consist of just one Multi with different Parts sounding in various passages of the song or it can consist of more than

one Multi which can be recalled with a single MIDI program change message.

As Kyra has dedicated resources for each Part and effects are an integral part of the Patch, a Patch will always sound the same regardless of which Part hosts it. So, as you assemble a Multi, you need not worry that a Patch will sound different as you configure Patches in other Parts as there are no bus effects shared between the Parts.

❗ Kyra does not use bussed effects – all effects are an integral part of the Patch so they'll sound the same regardless of which Part hosts them.

## Part Configuration

### Part Parameters

To inspect and modify the Part parameters, enter Multi Edit mode using the **Multi Edit** button. You can select which Part to edit at any time, before or after entering Multi Edit mode, by using the **Part Select** buttons. It's worth remembering this as it's common to configure Parts together and being able to flip through the Parts and compare/set values without having to exit Multi Edit mode each time is a definite time-saver. Once in Multi Edit Mode, you can edit the Part parameters in the same way as you edit Patch parameters.

If you make any changes to one or more Parts, be sure to store the updated Multi otherwise the changes will be lost when you change the Multi or switch off the synthesizer. Press the **Store** button at any point in the Multi Edit process (i.e. when the Multi Edit button is lit) to store the Multi. You can either overwrite the current Multi or write to a different one as part of the Store process.

Currently, Multis don't have names like Patches but there is a handy tip to achieve the same result: Copy the Patch in Part 1 to another Patch location (perhaps reserve a range of Patch numbers for this purpose). Rename the Patch to be that you want for the Multi. Then, change the Multi to

use this Patch rather than the original one. After this, when you flip through the Multis, you'll see these Patch names which will now be the 'name' of the Multis. This does assume you have Part 1 selected but that is usually the case unless you're building a new Multi - once built, it makes sense to stay on Part 1.

You can extend this idea to copy all the active Part Patches. The additional benefit to this is that your Multi will have its own copy of the Patches so that changes to the original Patches won't affect the Multi. A good strategy to adopt would be to reserve one Patch Bank for use in Multis. That way the Bank and Multis can be saved via MIDI so you have a backup copy of them all.

### No 'Single Mode'?

Kyra does not have a 'Single mode' that some other synthesizers have. It is by design a multitimbral system and therefore has no need for the additional complexity of a 'Single mode'. Kyra is always in Multi mode. This is a much simpler design where you don't need to think about any distinction between single and Multi mode.

A good practice is to adopt Multi 0 as the 'home' Multi where you set up the Parts for general purpose playing. In fact, for simple at-the-keyboard playing, you only need to set up one Part unless you're setting up layered/split con-

figurations. As Multi 0 is loaded when Kyra starts, all your settings and the Patch you configure for Part 1 in Multi 0 will be recalled at power up, so you can just switch on and play.

! Parts are numbered from 1 but Multis and Patches are numbered from 0 to match MIDI numbering.

Use the other Multis to save your performance configurations - either for live or studio usage. This gives you the best of both worlds: the simplicity to just switch on and play as well as the advanced configuration of all the Parts with a simple button push. Use the Multi Program change feature to allow your DAW or master keyboard to select the Multi. A good strategy is to use one Multi for each song. Your DAW can recall this Multi at the start of this song and Kyra will be instantly configured and ready to play the song. The DAW can then simply use the Multi throughout the song or it can change Patches within the Multi using program change messages or it can select another Multi to reconfigure all the Parts.

## Multi Parameters

- ❗ Press the **Multi Edit** button to access the Multi pages. There's only four pages and each press on the **Multi Edit** button steps to the next one so you don't have to (but can if you prefer) use the **Cursor Up/Down** buttons.
- ❗ Remember you can use the **Part Up/Down** buttons to switch Parts even when you're in Multi Edit Mode. This makes comparing setting across Parts very easy.

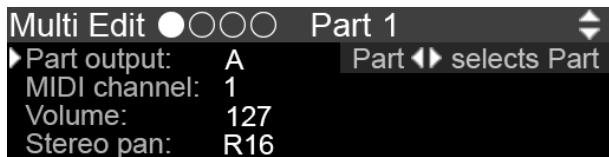

### Part Output

The **Part Output** setting selects which of the four stereo line outputs a Part is sent to. If more than one Part is sent to an output, they are mixed together by the Output Mixer. Remember that the headphone output is connected to Output A so any Part sent to a different output will not be heard on the headphones.

USB audio is not affected by the Part output setting as each Part has its own individual virtual stream over USB and the Output Mixer is not used.

The Output of the current Part is displayed (as 'Out') on the bottom line of the Home page.

### MIDI Channel

The MIDI Channel setting selects the MIDI channel a Part will respond to.

Select 'Off' to configure the Part not respond to any MIDI channel. This is useful if other instruments are connected via the MIDI Thru port.

The MIDI channel of the current Part is displayed (as 'MIDI') on the bottom line of the home page. The 'MIDI' label flashes to indicate Kyra is receiving MIDI (on any channel, not just the channel of the current Part).

### Volume

The Volume setting determines the volume (level) of the selected Part. This is displayed as "Level" on the bottom row of the Home page.

## Stereo Pan

The **Stereo Pan** setting positions the Part in the stereo field and is added to any Pan setting in the Patch itself. The Part Pan can be set by MIDI Pan continuous controller messages. Remember that unlike the Patch Pan, this pan control is post-effects so changing it will shift the whole signal, including any effects such as reverb. At extreme settings little or no signal will be heard on the opposite side regardless of the **Patch Pan** control. Use the correct pan control to achieve the effect you require. Hard panning a Part can be used to achieve mono effects sends with the analogue outputs and is especially useful with Part effects defeats. The Part Pan can be set by MIDI Pan continuous controller messages.

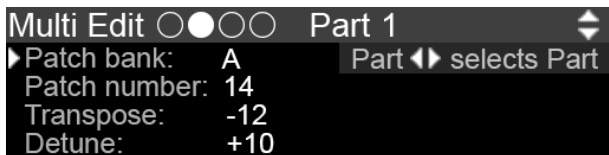

## Patch Bank

**Patch Bank** configures the bank of the Patch currently loaded into the Part. Currently, the Patch name is not shown here so it's easier to exit Multi Edit (just press **Exit**)

and adjust this parameter using the **Bank** (and **Patch**) buttons whilst on the Home page. You can then re-enter Multi Edit mode and continue editing the Multi parameters and then save the Multi. Changing the Bank (and hence the Patch) will stop any notes currently playing on the Part.

ⓘ You can select the bank using a MIDI Bank Select message (CC#32) but remember it won't take effect until a MIDI Program message is sent. If you're sending Bank and Program Change messages from your DAW or master keyboard, please ensure both the Bank and Program Change are being sent.

## Patch Number

**Patch Number** configures which Patch is loaded into the Part. As you can't see the Patch name here, it's easier to exit Multi Edit and adjust this parameter using the Bank (and Patch) buttons from the home page where you can see the name of the Patch (and you can hear the Patch too). You can then re-enter Multi Edit mode and continue editing the Multi parameters and then save the Multi.

## Transpose

The **Transpose** setting configures transposition (key shifting) of the Patch in the range -24 to +24 semitones relative to the MIDI note played. This parameter reflects

(and is the same as) the use of the **Transpose** buttons. Remember each Part has its own transpose value. If you want to transpose the whole Multi (all the Parts), you'll need to transpose all the Parts individually. Whole arrangement transposition will be easier in your DAW. Separate transpose is useful for layering Patches to play in different octaves or keys.

### Detune

The **Detune** setting allows fine detuning of the Part up to plus or minus one semitone in sub-cent steps. This is useful for layering (a technique where two or more Parts are set to the same MIDI channel) but also for 'humanising' songs whereby instruments being played are not precisely in tune. It makes the sound more interesting and less mechanical.

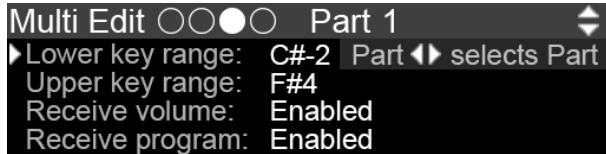

### Lower Key Range

The **Lower Key Range** sets key below which the Part will ignore MIDI notes sent to it. Useful for split keyboard setups in live play situations. Note the key shown (and the filtering done) is the original MIDI note and does not account for any transposition added using the Transpose feature. The setting can't be higher than the Upper key range.

### Upper Key Range

The **Upper Key Range** sets the key above which the Part will ignore MIDI notes sent to it. Useful for split keyboard setups in live play situations. Note the key shown (and the filtering done) is the original MIDI note and does not account for any transposition added using the Transpose feature. The setting can't be lower than the Lower key range.

### Receive Volume

The Receive Volume setting is a per-part setting to allow or disallow the reception of MIDI volume commands (CC #7). Receive Volume in the MIDI Configuration page must also be configured for MIDI volume to work on a given Part. Note that the level that MIDI Volume configures is the same as the Part Level, it isn't an additional level control.

Therefore, you can use your DAW to automate the mixing of all the Parts using MIDI Volume messages and the value stored in the Part would be the default level for the Part. You can of course use the multiple line outputs or the USB audio streams and mix the audio directly on your mixer or DAW, respectively.

### Receive Program

The Receive Program setting is per-Part setting to allow or disallow the reception of MIDI Program Change commands. Receive Program Change in the MIDI Configuration page must also be configured for MIDI Program Change to work on a given Part.

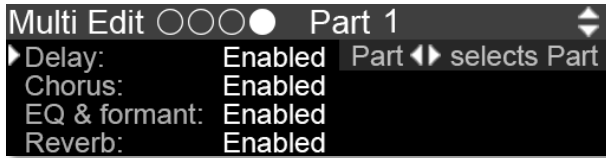

### Enable Delays

Enables or disables (defeats) the Digital Delay module for the Part.

### Enable Chorus

Enables or disables (defeats) the Chorus module for the Part.

### Enable EQ & Formant

Enables or disables (defeats) the EQ and Formant Filter module for the Part.

### Enable Reverbs

Enables or disables (defeats) the Reverberation module for the Part.

⚡⚡ Advanced users may wish to use these defeats to apply some or all effects in their DAW during the mastering phase of their project. The defeats allow selective removal of onboard effects without having to modify Patches.



# System Configuration

## Overview

Kyra's System Configuration is the set of parameters that allow you to configure Kyra to your requirements. To access the System Configuration pages, press the **System Edit** button in the Edit section.

Except for the Category Filter setting, all System Configuration settings are stored automatically and retained when the system is powered down. The Category Filter always defaults to disabled (off) when Kyra is powered up.

Each of the System Configuration settings is described below.

## System Edit Pages

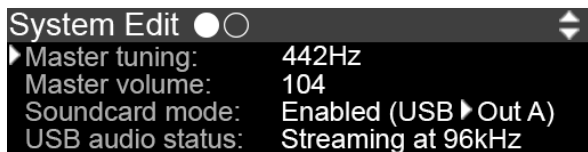

## Master Volume

The **Master Volume** setting configures the level of Kyra's line outputs. This is applied at the final digital to analogue conversion and is used to match the output of the system to your amplifier, mixer or headphones. It does not affect the USB audio streams. If you're using an external mixer or amplifier, set the **Master Volume** control to its maximum value and trim the levels on your mixer or amplifier. Master Volume can also be set by a MIDI Universal SysEx Device Control message. In both cases, the value set takes effect immediately and is stored.

⚠ Remember that **Master Volume** control does not affect the USB audio streams.

## Soundcard Mode

Kyra's **Soundcard Mode** allows you to route stereo audio from your DAW to Kyra. The audio will be sent to Output A (and correspondingly the headphone output). This allows you to use Kyra as a 'soundcard' to render the audio from your DAW (which could include sound from Kyra as well as virtual instruments on your DAW). As ASIO (currently) only allows one driver to be loaded at a time, you can't have Kyra and a separate soundcard active under ASIO on your computer although there are workarounds such as asio4all for Windows if you really want to use a separate sound-

card to render your DAW's audio. Note that Kyra's Soundcard Mode is of professional quality and renders 24-bit digital audio at 48kHz or 96kHz (it must be the same sample rate as audio from Kyra) so you're unlikely to notice any quality loss compared to using a separate sound card (in fact, it will probably be better).

- ❗ Use Kyra's Soundcard Mode to use Kyra's line outputs to render the audio from your DAW. This will simplify the configuration and wiring in many studio environment setups.
- ❗ Enabling Soundcard mode prevents Kyra outputting any of its own audio on Output A, the default output. **The Soundcard mode setting is retained when you switch off Kyra.** If you change your setup so that it expects synthesizer audio on Output A remember to switch off Soundcard mode **otherwise you won't get any sound from Kyra on Output A.**

### USB Audio Status

This is a status rather than an adjustable parameter. It shows the rate at which Kyra has been asked to stream audio to and/or from the host (your computer). If Kyra isn't streaming, the status will be 'Inactive'. Kyra allows the host to select streaming at 48kHz or 96kHz. Kyra al-

ways streams 24 bit audio but most host drivers can reduce this to 16 bit if required for legacy DAWs. For best quality results, configure your DAW to stream at 96kHz 24 bit. This will give you the best quality possible for any signal processing performed subsequently in your DAW.



### OLED Screensaver

The **OLED Screensaver** setting configures Kyra's screen saver to activate after 10, 30 (default) or 1 hour of inactivity of the front panel. There is also an option to disable the screensaver. When the screensaver is activated, the OLED display will be set to a reduced contrast level to extend its lifetime and reduce the chance of any image 'burn in'. The OLED display will revert to its standard level if any front panel control is used.

- ❗ If Kyra's screensaver or standby mode has activated, just press **Exit** to restore the display and continue your work.

## OLED Contrast

Sets the contrast level of the OLED display. The 'Standard' setting is recommended for general use.

## OLED Standby

Configures the length of time before the OLED display is switched off. Options are available for 2 hours, 4 hours and 8 hours. Standby mode can also be disabled. When Standby is activated, the OLED display will be switched off to extend its lifetime and reduce the chance of any image 'burn in'. The OLED display will revert to its standard configured level if any front panel control is used (use Exit to restore the display). Disabling standby mode or leaving the display on for extended periods is not recommended. Note that even when standby is disabled, the display will be put into standby mode (switched off) after 24 hours of inactivity.

## LED Brightness

Sets the brightness of the front panel LEDs. You may wish to select lower values to reduce glare in low-light studio or stage settings or higher settings in brightly lit outdoor areas.

## MIDI Configuration Display Pages

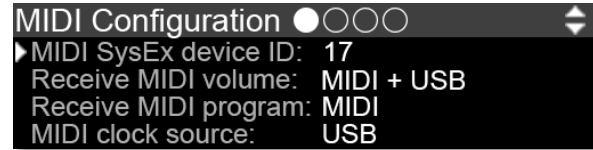

## MIDI SysEx Device ID

The **MIDI SysEx Device ID** used for MIDI Systems Exclusive (SysEx) communications, either between two Kyras or a Kyra synthesizer and a DAW/MIDI Editor/librarian. Unless the transmitting device sends on the 'all devices' ID, the Device ID setting on both units must be the same for communications to occur. Having a Device ID means you can have two or more Kyra units on the same DIN MIDI interface and address them individually with SysEx messages. In this setup, you'd need multiple MIDI Ins or a MIDI merge box to receive the return data from both units. If you use a generic MIDI utility, the Device ID setting on the synthesizer must match the Device ID used at the time the dump was saved. If you only have one Kyra on a given MIDI port or are using USB, leave this value at its default setting of 17. The Device ID applies to USB and DIN MIDI but is only useful for DIN MIDI setups with more than one Kyra in it.

ⓘ Don't change the Device ID from its default value unless you have more than one Kyra on a single DIN MIDI interface. There is never a reason to change it if you use USB for MIDI.

### Receive MIDI Volume

The **Receive MIDI Volume** setting enables or disables the reception of MIDI volume (CC#7) messages. This is a global setting that applies to all Parts. If MIDI volume reception is disabled with this setting, the setting in the individual Parts is ignored. You can select whether the messages will be received via DIN MIDI, USB or both.

### Receive MIDI Program

The Receive MIDI Program setting enables or disables the reception of MIDI program change messages. This is a global setting that applies to all Parts. If MIDI program change reception is disabled with this setting, the setting in the individual Parts is ignored. You can select whether the messages will be received via DIN MIDI, USB or both.

### MIDI Clock Source

The MIDI Clock Source setting determines whether MIDI Clock messages will be received via DIN MIDI or USB MIDI.

There's no disable option as MIDI Clock can be used by several modules with Kyra, each of which has an individual MIDI clock configuration.

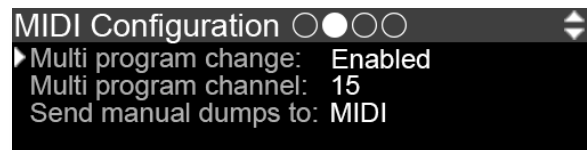

### Multi Program Change

The Multi Program Change setting enables or disables the use of a MIDI Program Change to select the current Multi. When enabled, a MIDI Program Change on the nominated MIDI channel will recall the Multi specified by the Program Change instead of any action it would have taken (i.e. a Patch change on a given Part). Disabling Multi program change ensures MIDI Program Changes will perform their intended action. Multi Program Change is a great feature to allow instant recall of all 8 Parts and their configurations using just a single MIDI Program Change command and is particularly useful for live performances.

## Multi Program Channel

Selects the MIDI channel used by the Multi Program Change feature. The value is ignored if Multi program change is disabled. As Kyra has 8 Parts (and hence up to 8 MIDI channels) it makes sense to use a MIDI channel not used by any Part. That way, MIDI Program Changes on Part channels operate exactly as intended and the additional feature of Multi Program Change uses its own channel. See also Multi program change.

! If you use Kyra's Multi Program Change feature, it makes sense to use a MIDI channel that is not used by any of Kyra's Parts.

## Send Manual Dumps To

The Send Manual Dumps To option configures which MIDI port manual Patch and Multi dumps will be sent to.

! Advanced users can use manual dumps to record Patches and Multis in their DAW or custom MIDI applications.

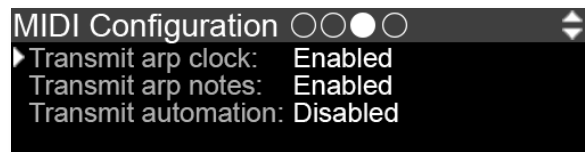

## Transmit Arp Clock

The Transmit Arp Clock setting enables or disables the transmission of MIDI Clock for the Arpeggiator on Part 1. To save MIDI bandwidth, switch this off if it isn't required. The option allows Kyra to send the MIDI clock via DIN MIDI, USB or both.

! As MIDI can only support one clock, only the clock for the arpeggiator on Part 1 can be sent. This isn't really a limitation as it'd be very unusual to have asynchronous arpeggiators on multiple Parts.

## Transmit Arp Notes

The Transmit Arp Notes setting enables transmission of each note played by the arpeggiators (there can be one on each Part) to be sent as MIDI note events. This allows you to send and/or record the notes played by the Arpeggiator so they can be edited and played back as individual notes on Kyra or another synthesizer. This feature can use a lot

of MIDI bandwidth, especially when the Arpeggiator is in Chord Mode. The options allow you to configure Kyra to send the notes via DIN MIDI or USB (but not both).

 You can overwhelm DIN MIDI quite easily with Arpeggiator note transmissions, especially in Chord Mode. This will result in poor timing and/or lost notes.

### Transmit Automation

The **Transmit Automation** setting configures the front panel controls related to Patch parameters to transmit MIDI SysEx messages when they are changed. These messages can control another Kyra, or more usefully, they can be recorded by a DAW for control automation. To save MIDI bandwidth, switch this off if it isn't used. The option allows Kyra to send the automation messages via DIN MIDI or USB.

 The best way to perform automation is to use MIDI CC (Continuous Controller) messages routed via the Mod Matrix. These CCs can come from your DAW or master keyboard's assignable controls.

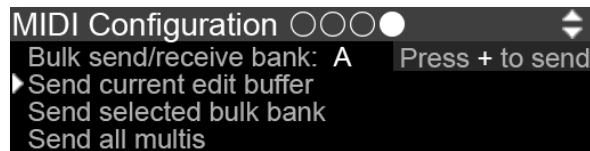

### Bulk Send/Receive Bank

The Bulk Send/Receive Bank option configures which of Kyra's Patch banks will be sent **and** received by manual MIDI SysEx messages. Be sure to have this set correctly when sending bulk Patch dumps to Kyra; an incorrect setting could result in a whole bank of valuable Patches being overwritten. It is also good practice to set this value to OFF when not in use. This ensures any generic manual SysEx banks sent to the system will be ignored (although a specific bank SysEx dump can still be done - but they can only come from an Editor/Librarian application and not another Kyra). This value is not stored when system is powered down and will default to OFF each time the system starts.

You can send ROM Banks. If a Bank is received via MIDI when a ROM Bank is selected in Bulk send/receive bank, it will be ignored. To copy a Bank to ROM, send it to a RAM Bank first and then copy it to the required ROM Bank using the Copy Patch Bank page.

These options are intended for sending individual and whole Banks of Patches from one Kyra to another without a computer (by wiring the MIDI out of the first system to MIDI in of the second system). Ensure SysEx is enabled on the receiving system and the Device IDs are the same on both.

❗ The main use of manual dumps is for advanced users with custom MIDI setups and to send Patch Banks and Multis from one Kyra to another one without using a computer.

### Send Current Edit Buffer

When **Send Current Edit Buffer** is activated (using the **Value Up** button), Kyra will immediately send the Edit Buffer of the current Part as a SysEx message. Providing it was configured correctly, a Kyra synthesizer attached via DIN MIDI would place this in its current Part's Edit Buffer. The data is sent via the port (DIN MIDI or USB) configured in the **Send Manual Dumps To** option in the MIDI Configuration page.

❗ Send Current Edit Buffer will never overwrite a stored Patch in the receiving Kyra.

### Send Selected Bulk Bank

When Send Selected Bulk Bank is activated (using the **Value Up** button), Kyra will immediately send the whole bank selected by the Bulk send/receive bank option as a series of SysEx messages. Owing to the amount of data involved it takes about ten seconds to complete if DIN MIDI is being used - it is instantaneous if USB MIDI is selected. Use this feature to back up your Patches to another Kyra, a DAW, a generic or custom librarian or a MIDI utility with SysEx capability. If backing up directly to another Kyra via DIN MIDI, ensure its Bulk send/receive bank is set correctly so that you don't overwrite Patches you wish to retain.

The data is sent via the MIDI port (DIN MIDI or USB) configured in the Send Manual Dumps To option in the MIDI configuration page.

⚠ Any Kyra that receives these messages will **overwrite the whole Bank** it has selected in **Bulk send/receive bank** without warning. If you have multiple Kyra units connected, ensure everything is configured correctly and your Patch Banks are backed up.

❗ **Bulk send/receive bank** defaults to Off so no Patches will be overwritten unless you changed this setting since you last powered up Kyra.

### Send All Multis

When Send All Multis is activated (using the **Value Up** button), Kyra will immediately send all the Multis as a SysEx message. Use this feature to back up your Multis to another Kyra system, a DAW, a generic or custom librarian or MIDI utility. Note that Multis rely on the Patches they reference - if the required Patches are not present at the referenced locations the Multi will not sound as intended.

⚠ Any Kyra that receives these messages will **overwrite all its Multis** without warning. If you have multiple Kyra units connected, ensure everything is configured correctly and your Multis are backed up. Unlike Patch Dumps, there's no Bank setting (as there's only one bank of Multis) so the overwrite will **always** occur.

### Patch Storage - Copy Patch Bank

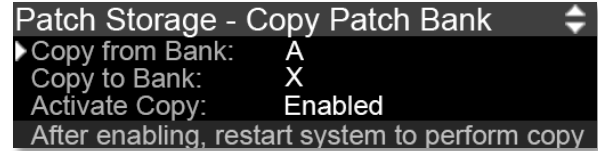

The Copy Patch Bank feature allows you to copy whole banks of Patches between any of Kyra's 26 memory banks. Recall each Bank comprises 128 Patches. You can copy between any two banks regardless of whether they are RAM Banks or ROM Banks.

⚠ Ensure the selected Copy to Bank does not have any Patches you want to keep (or is backed up) before activating the copy as the entire Bank will be overwritten.

The procedure to copy Patch Banks is:

1. Locate the Copy Patch Bank page in the System Edit pages.
2. Set the Bank you wish to copy from in "Copy from Bank". Any Bank can be selected.
3. Set the Bank you wish to copy to in the "Copy to Bank". Again, it can be any of the Banks from



A to Z. It should be different to the Bank you are copying from otherwise no changes will be made.

4. Set the Activate Copy option to 'Enabled'.

The copy operation will be performed when you next power up Kyra (e.g. from Standby). You can do this straight away by pressing and holding both the **Transpose** buttons to place Kyra into standby and then powering up again or you can do it any time later and any changes you make to the Bank to be copied will be included. The settings in the Patch Bank Copy page are set back to their defaults with Activate Copy set to Disabled when the system is powered on again to prevent any inadvertent copies; it is not necessary to set Activate Copy back to Disabled after a Bank copy. You can change it back to Disabled if you want to cancel a copy instruction before you power down Kyra.

⚠ Kyra automatically de-activates Copy after it has completed the copy operation.

The Copy Patch Bank feature is the **only** way you can write Patch Banks to ROM Banks (i.e. banks in the range H-Z) – you'll need to configure it to transfer to a RAM Bank first and then use the **Copy Patch Bank** feature to copy the Bank to ROM subsequently.

## Patch Control

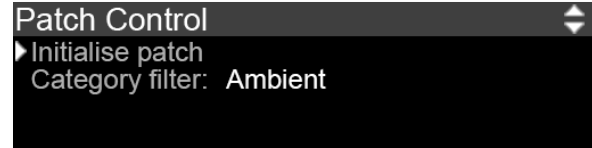

### Initialise Patch

**Initialise Patch** reverts all the settings in the current Part's Edit Buffer back to their default values. This is useful for creating a 'clean canvas' Patch from scratch without any unexpected settings from an existing Patch. Note that only the Edit Buffer is initialised, no stored Patches are changed unless you store Patch using the Store sequence. Once the Patch is initialised, the page switches to the Home page ready for you to start work. A default patch has the name "Default Patch Name" and plays a simple sawtooth waveform.

### Category Filter

The **Category Filter** allows you to browse Patches of a specific category. At power up, the Category Filter is off ('no filter') and browsing Patches using the **Patch** (and **Bank**) buttons simply steps through each Patch in se-

quence. When the filter is enabled, the **Patch** buttons will step through the Patches of the specified category, regardless of Bank. The **Bank** buttons have no function when the Category Filter is active.

❗ The Category on the Home Page flashes to indicate a Category Filter is active.

The selected Category will appear as soon as you use the **Patch** buttons (the current Patch won't be changed if it is not in the selected Category). If there are no Patches of the filtered category, the Patch buttons step through all the Patches in the Bank and the **Bank** buttons can be used. To disable the Category Filter, change it back to 'no filter' in the Patch Control page.

❗ The **Bank** buttons do not have a function when a Category Filter is active.

The Category Filter does not affect MIDI Program changes, they operate as before and are able to select a Patch regardless of category.

## System Build

This page shows the software version, hardware version and serial number of the system.

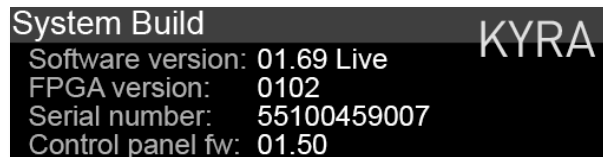

❗ Use the Software version number to determine if there's an updated version of firmware available for your Kyra.

# Kyra Sound Programming

## Introduction

In this section we take a closer look at Kyra's capabilities. To move beyond using preset Patches and making simple edits to them, you'll need a deep understanding of Kyra's architecture.

Once you have mastered Kyra's architecture, we're confident you'll be able to create amazing new sounds.



Once you've worked through Kyra's factory presets, you'll want to create your own new, exciting sounds for Kyra. You've come to the right place to learn how to do that ! Here at Waldorf, we always encourage users of our synthesizers to dive in and explore.

Don't worry if they seem daunting in the first instance, it will become clearer as you read and experiment. A good understanding of the architecture is important for getting the best sounds from Kyra.

As you saw in earlier sections, Kyra's sound generators operate in **Wave** or **Hypersaw** mode. It isn't possible to configure both at the same time but with Kyra's massive polyphony, you can achieve this by layering a Wave mode Patch with a Hypersaw mode Patch.



User layering if you want Wave and Hypersaw sounds together.



By layering eight dual hypersaw sounds (and detuning them) you can achieve as many 96 oscillators on a single note and still play 8 notes. Please don't underestimate the power of layering to create **massive** sounds on Kyra.

## Sound Generation

### Overview

We start by reviewing the sound generation architecture of Kyra. The diagrams in this section detail the configuration and signal routing of sound generation modules in Kyra.

## Wave Mode Architecture – Single Filter

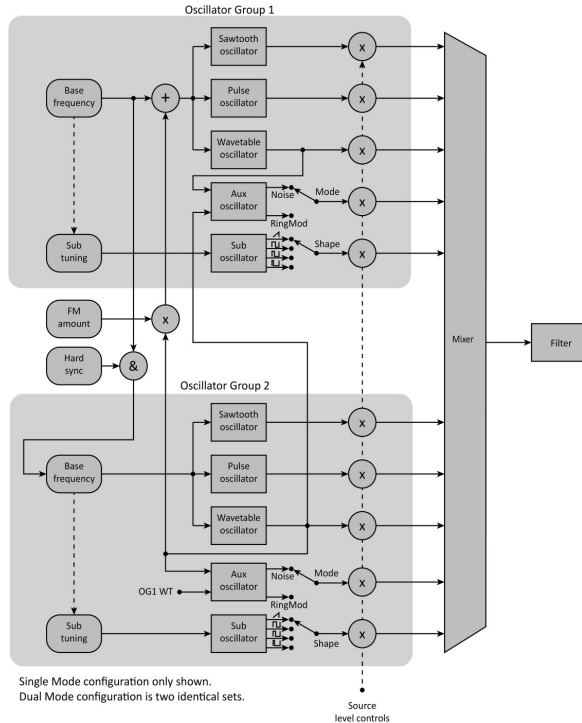

In Wave Mode, when Dual Mode is off, two independent Oscillator Groups are mixed together and are routed to the Filter as shown in the diagram.

When Dual Mode is selected, everything is doubled up (not shown in the diagram) so there are two Oscillator Group pairs (a total of 20 oscillator sources!) and each pair is routed to a separate filter with a true stereo signal path. However, the filters can't be adjusted individually other than using stereo LFOs. If individual filter control is required, select Dual Filter Mode. In either case, you can detune the two Oscillator Group pairs.

 Remember in Dual Mode, you can detune the two voices using the Dual Mode Detune setting.

## Wave Mode Architecture - Dual Filter

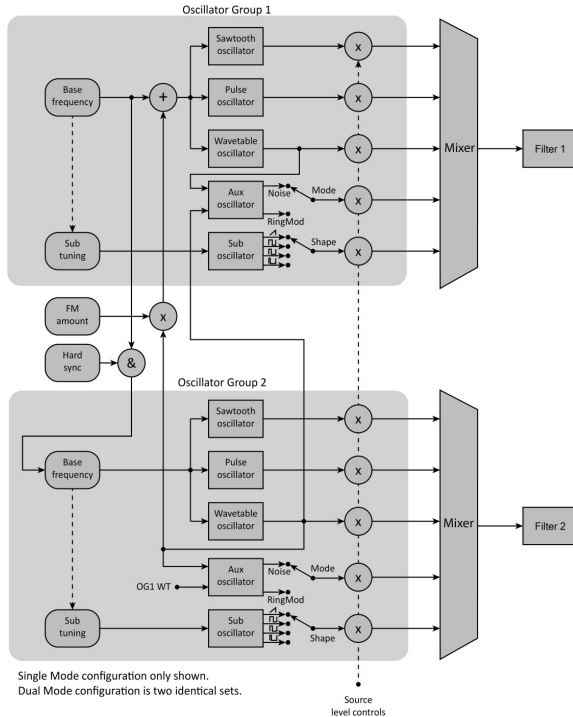

When Dual Filter mode is selected, the signal routing changes as shown in the diagram. Even though Dual Filter mode uses two voices, only one Oscillator Group pair exists (unlike Dual Mode, Single Filter mode). However, they are individually mixed and routed to separate Filters which can be configured and modulated individually. Note that the Aux Oscillator is present in both groups but has a common Mode and Level setting. As a result, the output of the Aux Oscillator will always be presented to both Filters. This is not the case for the other oscillators which allow individual control per Oscillator Group.

🔧🔧 Dual Filter Wave Mode offers the maximum flexibility in designing advanced Patches. Remember the two filters can be configured completely independently (including being of different types).

🔧🔧 With all that power comes the need to plan your Patch design. Unlike simpler configurations, it's not easy to 'stumble' across a killer sound in Dual Filter Mode.

## Hypersaw Mode Architecture

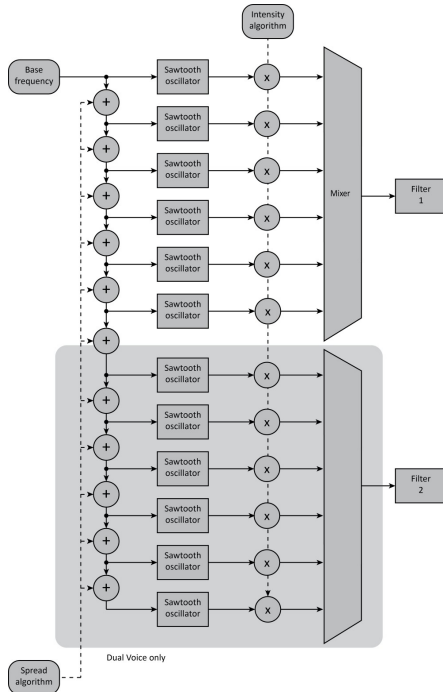

In Hypersaw Mode, Kyra dedicates and manages six oscillators in the hypersaw algorithm. When Dual Mode is selected, the hypersaw algorithm is extended twelve oscillators and two filters are used for a true stereo signal path. The diagram shows the signal flow for Hypersaw Mode (in single and Dual Mode configuration). Remember Kyra manages the two filters for you in Dual Mode Hypersaw – Dual Filters Mode isn't available in Hypersaw Mode.

🔊 In Hypersaw Dual Mode, Kyra interleaves the partials and spreads them across the stereo stage resulting in some very phat sounds.

## Programming Tips – Wave Mode

### Overview

Kyra adopts a virtual analogue synthesis model which has the advantage that it is easy to construct sounds using intuitive subtractive synthesis. It adds its own twists though, with the massive wavetables being notable. But don't be fooled, Kyra is not a 'rompler' (sample player) that plays canned samples, the perfectly-looped, single-cycle wavetables are designed for crafting new and exciting sounds far beyond that possible with a rompler.



Kyra's wavetables are an important part of the sonic capabilities of Kyra. Even though they're static you can 'slice and dice' them with the Ring Modulator, Hard Sync and FM as well as cross-fade between them with any modulator you wish.

When Kyra is in Dual Mode and Dual Filter mode is also enabled, each of the Oscillator Groups is routed through its own, independent filter. If Kyra is in Dual Mode but Dual Filter mode is off, the two Oscillator Groups will still pass through two independent filters, but the filters will both be controlled by a single set of controls and the only difference between the two groups will be when stereo LFOs are used. This is to permit a true stereo signal path.

### Wave Mode Sound Sources

Within each oscillator group, you'll find the following independent sound sources:

**Sawtooth:** A harmonically-rich tone ideal for modeling with subtractive synthesis.

**Pulse:** A basic tone featuring odd harmonics that can be adjusted from a square wave (manually or via a modulator) to a very thin pulse wave. Pulse width modulation (PWM) results in a very distinctive classic synthesizer sound.

**Sub Oscillator:** An oscillator that can play at the root pitch of the Oscillator Group or one octave below. The waveform can be one of four preset waveshapes, sawtooth, square, pulse or triangle. Each of the two Oscillator Groups has its own Sub Oscillator. The Sub Oscillator can be detuned (up to one semitone each way) relative to its parent group. You can use the Subs as bass-enhancing sound sources or as generic, detunable components to add thickness to the sound. Sub Oscillators in root pitch mode are especially useful for adding detuning effects to the Oscillator Group when Hard Sync is enabled as they are not involved in Hard Sync, FM or Ring Mod effects. In that respect, they can be viewed as completely independent oscillators.

**Noise:** A special, unpitched tone used to model wind and rushing effects produced by the Aux Oscillator. Note that even though each Oscillator Group does in fact have its own Aux Oscillator, there is only a single level control for both which is the Aux Level control in Oscillator Group 1's control page. As a result, in Dual Filters mode, noise will be presented to both filters if the Aux level is above zero. Noise is produced by the same source as the Ring Mod output, so you can have on or other depending on the Aux Oscillator Mode setting in Voice Control.



Another use for noise is to 'grunge up' a sound. Adding some noise and filtering it correctly can give sounds a distinctive lo-fi quality as if they were recorded using an old tape recorder.

**Ring Modulator:** The Ring Modulator (Ring Mod) is a special effect and a sound source itself (the Aux Oscillator). It operates on the wavetables of both Oscillator Groups to produce its output. Note that even though each Oscillator Group does in fact have its own Aux Oscillator, there is only a single level control for both which is the Aux Level control in Oscillator Group 1's control page. As a result, in Dual Filters Mode, Ring Mod audio will be presented to both filters if the **Aux Level** is above zero. Ring Mod is produced by the same source as the Noise output, so you

can have one or other depending on the **Aux Oscillator Mode** setting in Voice Control.



The Ring Modulator has a separate level control so you can use a modulator to adjust the amount of Ring Modulation in a sound as it evolves. This can result in some very creative possibilities. Try using this technique to give a sound a sharp, dissonant attack and then evolve into a purer sound with fewer harmonics.

**Wavetable:** A large palette of 4096 mathematically generated, perfectly looped single-cycle wave shapes covering a large range of timbres.



## Wave Mode Hard Sync

Hard Sync is a technique that mathematically links two oscillators to generate further sound possibilities. On Kyra, this occurs between the two Oscillator Groups and is either on or off, there is no level or intensity setting.



Take some time to experiment with Hard Sync. It can generate sounds that are not possible to achieve any other way. On Kyra, it excels at obtaining evolving harmonic textures from the two Wavetables.

Simply stated, Hard Sync uses the cycling of one oscillator (in this case the root frequency of Oscillator Group 1) to trigger (reset) the cycle of another (in this case, Oscillator Group 2). In this configuration, Oscillator Group 2 behaves somewhat differently in that its fundamental frequency is locked (synchronised) to that of Oscillator Group 1. However, adjusting the tuning interval between the two oscillators (typically by applying a pitch modulation, static or dynamic, to Oscillator Group 1) results in timbre changes in Oscillator Group 2 rather than the detuning effect it would normally have. This timbral change offers a wide spectrum of sounds that could otherwise not be achieved and work particularly well with the wavetable sounds. Unlike FM (frequency modulation) almost all Hard Sync configurations are harmonic and getting to a useful sound

does not take nearly as much effort as it does with FM. The best effects are achieved when the frequency ratio between the Oscillator Groups is up to one octave either way.

It is worth noting that Sub oscillators are not part of Hard Sync and they operate independently of Hard Sync. As Hard Sync tends to produce very tonally pure sounds, you may want to switch the subs to Root Pitch mode or turn them off as their wide tonality can be a distraction from the pure Hard Sync sound. On the other hand, they offer the ability to provide additional detuning effects that may otherwise be missing from a Hard Sync sound (as detuning is, by definition, not possible between two hard sync'd oscillators). As always, experimentation is key.

There are two distinct uses for Hard Sync. The first is to use it in a static configuration simply to obtain new timbres, usually from the wavetables in the two Oscillator Groups. By adjusting the relative tuning between the Oscillator Groups using the Oscillator Group 2 **Tune** and **Detune** controls, you will hear distinct timbral variation. So long as the ratio of tuning remains constant (as it will unless you are using exotic modulation matrix configurations) the timbre will be consistent across notes.

The second and more interesting use is a dynamic configuration whereby the ratio of frequencies between the two oscillator groups is varied by a modulator (e.g. an envelope

generator or LFO). When this is done, rather than hearing a pitch change, you will hear a timbre change and when set correctly, the sound can be very rich and animated. Check out 'The Emperor Piano' preset. The rich, evolving timbre variation during the decay period of the piano is achieved using a dynamic hard sync of wavetables. It would not be possible to achieve that effect using a filter as filters only remove harmonics - Hard Sync is creating new and shifting harmonics as the note evolves. It is most useful for creating intense, evolving, tonally pure sounds but also great for techno basses with that signature sync sound. Hard Sync can add evolving tonal variation and grain index-like effects to otherwise flat wavetable sounds with very little programming effort. Also, check out the preset 'The Synchronotron' where extreme Hard Sync is used with velocity mapping to achieve a very distinctive techno effect.

In summary, be sure to make good use of Hard Sync. Note that at least one sound source in Oscillator Group 2 must be audible for hard sync to have any effect. You can use hard sync on the basic virtual analogue sounds (pulse, sawtooth) but it is by far most effective for use on wavetable sources. Hard Sync is not available in Hypersaw Mode and has no effect on the Aux and Sub Oscillators.

 Avoid using Hard Sync with FM, they are contradictory and the result is rarely musical.

## Wave Mode Frequency Modulation

Frequency Modulation (referred to as 'FM') is a technique to make one oscillator (the modulator) to modulate the frequency of another (the carrier). Just as you can use an LFO to modulate the pitch of an oscillator, FM is the same as that just at audio frequencies.

FM traditionally has a characteristic metallic bell-like sound but as with hard sync, think of it as having more applications than that. Compared to Hard Sync, FM takes more time to achieve useful sounds but like Hard Sync, it can achieve sounds that are very difficult to achieve in other ways.

 You'll need to experiment much more to get useful sounds with FM. It's worth the effort though.

On Kyra, FM operates by using the wavetable output of Oscillator Group 2 to modulate the frequency of Oscillator Group 1. As with hard sync, noise the sub oscillators are not affected and can be used independently as before. As Oscillator Group 1 is the destination of FM, at least one sound source (saw, pulse or wavetable) in Oscillator Group 1 must be present for FM to be heard.

The idea behind FM is that the frequency ratio between the two oscillators, as well as the shape and degree (intensity)

of the modulation creates additional harmonics (usually quite a lot of them!). Those harmonics will be pleasing at certain ratios or highly dissonant otherwise. Depending on the sound you're looking to achieve you may want to turn off all the sound sources in Oscillator Group 2 if you are using a swept frequency ratio or dissonant ratio as that will likely be a distraction. Note that the tap for the Oscillator Group 2 wavetable for FM is before the level control for that sound source so you can mute it (set its level to zero) along with any and all of the other sources in Oscillator Group 2 and still achieve the FM effect from Oscillator Group 1 sources. This may be useful if the frequency of Oscillator Group 2 is set to be a varying inharmonic to Oscillator Group 1. If the ratio is harmonic, you may wish to leave some of Oscillator Group 2's sources present in the mix.



You can mix the two sources (carrier and modulator) and the FM amount as you wish using modulators. It's very flexible.

As mentioned, you'll need to experiment far more to get useful sounds from FM and just like classic FM synthesizers. In mentioning classic FM keyboards, they had multiple (typically 4 or 6) FM components (often called 'operators') but they typically only generated very simple waveforms such as sine waves. On Kyra, even though there are

only two components participating in FM (the two Oscillator Groups), recall that the carrier can be any of the VA waves or any wavetable and the modulator can be any wavetable. FM on these complex waveforms can result in some very interesting tones but as mentioned, you'll need to experiment extensively to get great sounds. Some wavetable groups are more useful than others for FM purposes - tonally simple waveforms such as those in the FM and Overtone groups are most useful. A modulating waveform that has a non-zero bias (i.e. is positive more than it is negative or vice versa) will cause a pitch shift of the note so it's best to use symmetric waves for the FM modulator. Many (but not all) waves in the FM group are symmetric. The carrier wave does not need to be symmetric.



Kyra uses FM rather than phase modulation. That's why the modulator needs to have zero bias to avoid a pitch shift.

As FM and Hard Sync are contradictory processes, it does not make sense to use FM when Hard Sync is enabled. It won't be useful and, in most cases, will force the oscillators out of tune. On the other hand, FM works very well with the Ring Modulator.

In summary, FM needs a lot of experimentation to yield good results but when it does, the sound can be very distinctive and hard to achieve without FM. It's good for

crunchy basses as well as percussive metallic effects and adding a sharp edge to electric piano sounds FM synthesizers became famous for. On Kyra, as the wavetables cover many of these sounds directly, FM more useful for achieving controlled distortion. Remember that FM has an intensity control and it can be the destination of a modulator in the Mod Matrix, so you can vary the intensity of the FM effect using a modulator (e.g. only apply it during the initial part of a sound or increase the FM with aftertouch).



Be sure to use Kyra's Mod Matrix to control the FM variables (the frequencies and shape of the carrier and modulator as well as the FM output level).

## Wave Mode Ring Modulator

Ring Modulation (referred to as 'Ring Mod') is a technique where two signals are mathematically multiplied. The result of this is the production of a massive number of additional harmonics, the sound of which vary hugely on the waveforms (and hence harmonic content) of the two source sounds as well as the ratio of their frequencies - even a tiny amount of fine tuning can produce dramatic results. Ring Mod is an all-time classical effect and has been used in countless productions for decades.

Like FM, Ring Mod is contradictory to Hard Sync and using Ring Mod with Hard Sync is unlikely to be useful. On the other hand, Ring Mod works exceptionally well with FM and can add considerable grit to the sound.

As with FM, you'll need to experiment to get great sounds and Ring Mod. Experiment with the wavetable shapes and the semitone intervals between the two Oscillator Groups to obtain the best effects. Unlike FM, Ring Mod does not affect the operation of any of the existing oscillators, it takes the output of the two wavetables and produces a new sound source.

On Kyra, the Ring Mod operates on the two wavetable oscillators, one of which is present in each of the Oscillator Groups. The two signals are taken before the wavetable level controls, so you can choose whether to hear one or both original wavetable sources with the ring modulated output or just the ring modulated combination and anywhere in between. As there are three level controls in total for the Ring Mod, the two wavetable levels as well as the Aux Oscillator level, you can mix the three however you wish, either manually or via the Mod Matrix.



Be sure to use Kyra's Mod Matrix to control the Ring Mod variables (the frequency ratio as well as the three levels - the two inputs and the Ring Modulator output).

As Ring Mod is performed by the Aux Oscillators, you'll need to choose the Ring Mod as the Aux Oscillator function in the Voice Control page before it can be used. Once enabled, the Aux Level control in Oscillator Group 1 will set the level of the Ring Mod output. You can modulate this in the Mod Matrix as required.



Routing velocity to Ring Mod EG modulation amount using the Mod Matrix is a great technique to bring up additional harmonics during the attack phase of a note as notes are played harder. Several of the factory presets use this technique.

## Bringing It All Together

Each one of the Wave Mode oscillator sources are independent and can be used simultaneously. Use the level controls for each source to mix them together to get exactly the sound you want.

It's important to note that the level control for each source is available as a destination in the modulation matrix so can be controlled by many modulation sources, e.g. envelope generators and LFOs. This provides many opportunities for advanced synthesis including the ability to cross-fade (morph) between any two wavetables using any modulator including EGs, LFOs, performance controls as well as per-note modulation such as velocity.



All the source Level controls can be controlled via the Mod Matrix. There's a lot of possibilities!

Kyra's wavetables offer almost limitless possibilities. There are a few useful tips to bear in mind when using the wavetables:

In their most basic form, you can use the wavetables to generate static timbres beyond those offered by the basic oscillators. You can mix these in using the Wavetable level controls and then select the wavetable itself.

Beyond static wavetables, you can apply modulators to the wavetables so adjust their relative levels; as there's two wavetables (one in each oscillator group) you can use modulators to smoothly cross-fade between the two tables to generate interesting, evolving timbres.

Remember to make use of the Subs for additional bass (sub mode) or detunable thickness (root mode).

As a final step in your path to wavetable mastery, learn how to use FM, Hard Sync and Ring Modulation to get dramatic evolution of wavetable sounds. By applying modulators to these techniques, you can achieve extremely dynamic sounds.



Sound Programmers have often avoided techniques such as FM, Hard Sync and Ring Modulation VA synthesizers as they caused a lot of aliasing. With 32x oversampled hardware sound generation, that's not a problem on Kyra.

A good technique to learn is to use a wavetable sound at the beginning (the attack portion) of a sound. For musicians who have used classic Roland LA (linear arithmetic) synthesizers this should be very familiar. It's a great way to get that extra 'snap' or 'punch' at the beginning of a sound. Several factory presets use this technique and most use EG3 for the attack (very fast attack, short decay) mo-

dulator leaving EG2 free for modulation throughout the rest of the note.

With such a large set of available wave shapes in the wavetables, once combined with these methods to combine and modulate the two wavetables in a Patch, the possibilities are endless. It can take some time to find the right waveshape and combining effect, but you'll get more adept at it as you work with Kyra and get to know your way around the wavetable groups.



We recommend you study the factory presets as part of your journey to becoming Kyra sound programming guru. Experiment, experiment, experiment!

## Hypersaw Mode

### Overview

Kyra's Hypersaw uses a special algorithm to create lush soundscapes quickly. Hypersaw Mode replaces Wave Mode's two Oscillator Groups with a single source whose tonal content is constructed with just two controls, **Intensity** and **Spread**. Built entirely out of multiple, harmonically-rich sawtooth waves (referred to as 'partials') each adjusted according to a special algorithm, the Hypersaw

provides characteristic soundscapes ideal for a range of uses from high impact lead sounds through to lush, animated pads.

### Bringing It All Together

The two Hypersaw parameters are available as destinations in the Mod Matrix for some truly wonderful modulation possibilities. Mappings of channel pressure (aftertouch) or envelope generators to Hypersaw Spread is particularly effective routing and is used in many of the factory hypersaw patches.



Even though you have far fewer parameters to play with in Hypersaw Mode, you can and should use them effectively. Modulating the Spread parameter results is extremely effective. Try modulating Spread with velocity, LFOs, EGs or aftertouch!

The Hypersaw Sub oscillator option drops the pitch of the two most extreme partials of the hypersaw by one octave and can give certain hypersaw sounds a distinct bass boost. The effect is more pronounced with higher levels of Hypersaw Intensity.



The Hypersaw sub is not always beneficial to a sound as it can detract from the purity of certain sounds such as pads. On the other hand, for huge sounds, it can help a lot. Flip the sub on and off and pick the setting that sounds best.

Other than Intensity and Spread, the only other controls that are used in Hypersaw Mode are the pitch modulation controls (**Tune, LFO1 to Pitch**) in Oscillator Group 1. This applies to Mod Matrix routings as well.

Remember to consider the overall Patch Level when increasing the Hypersaw intensity as increasing the intensity adds significant energy to the signal. If Hypersaw Patches get too loud, the limiters will kick in. This may or may not be desirable depending on the sound you're trying to achieve.



As hypersaws are so harmonically rich, they provide a great source for Kyra's filters. Try feeding the Hypersaw into Kyra's 24dB (4-pole filters) with a good amount of resonance and modulate the filter. It's easy to get great results with the Hypersaw and Kyra's ladder VA filters.



## Comparing Wave and Hypersaw Mode

When creating sounds bear in mind that Hypersaw is useful for a relatively narrow (but highly pleasing and popular) range of sounds. It lacks much of the flexibility of Wave Mode and relies almost entirely on the filters to achieve significant evolution of timbre as the note sounds.

In Wave Mode you have a vast palette of wavetables to draw on as well as the ability to modulate parameters like Pulse width, FM, ring mod and the ability to cross-fade the various sound sources using the Modulation Matrix to achieve very complex, evolving timbres. As always, experimentation is the key to getting the right sound.

You can re-create most of the functionality of Hypersaw Mode in Wave Mode; you get the same number of oscillator sources (by setting the Wavetable to a sawtooth and operating the Sub Oscillators at root pitch) and they need not be sawtooth waves either. You don't get as much detuning control (four pitches rather than six) but you can choose alternative tunings and modulations that Hypersaw Mode can't achieve. You also get the advantage of having two independent filters to process the sound. It takes some time to configure but the results can be outstanding.

By setting the Wavetable to a square wave (or similar) and the Sub Oscillator to a root pitch square or pulse, you can configure a 'Hypersquare' – a variation of a hypersaw that

uses square or pulse waves. You can mix and match to combine the two, the possibilities are endless.

Even though Kyra doesn't allow Hypersaw and Wave Mode to be used at the same time, you can achieve very similar effects by using the techniques described above. As mentioned, layering a Hypersaw and Wave Mode Patch is another way to achieve this without compromising the number of oscillator sources. Kyra is powerful enough to do this even when playing big chords with long release times.

## Using Dual Mode

Dual Mode doubles up two Kyra voices to build on both Wave Mode and Hypersaw Mode configurations. Dual Mode is not simply a unison of two voices.

Designed for sounds that need extra impact and stereo width, Dual Mode doubles up Kyra's oscillators and filters to provide a true stereo signal path. Additionally, in Hypersaw Mode, Dual Mode doubles the resources available to the hypersaw as well as providing true stereo imaging to provide an amazing twelve partial stereo hypersaw sound. In Dual Mode, alternate hypersaw partials are sent to each side of the stereo bus via its own filter.

Dual Mode features a Panorama control to allow you to adjust the stereo spread of the voice. By default, this is at

its maximum setting to provide the widest stereo field for Dual Mode patches but you may wish to restrict the stereo width the sound occupies in a mix by reducing the Panorama value. The sweet spot for most Dual Mode sounds is in the range 64 to 96.

Note that Dual Mode (including Dual Filter Mode) is the only option that reduces Kyra's polyphony. Dual Mode uses two voices for each note sounding. It's unlikely to be a problem as Kyra has 128 dedicated contention-free hardware voices but it's worth restricting Dual Mode to use on just two or three Parts in dense compositions. Note that when Dual Filter mode is engaged, Dual Mode is also switched on. This still only uses two hardware voices, not four.

When Kyra is configured for Wave Mode and Dual Mode, the Dual Mode Detune control in Voice Control allows the two stacked voices to be detuned to add extra depth. Dual Mode Detune isn't used in Hypersaw mode as the Hypersaw algorithm manages the detuning of all the partials. In Wave Mode, be sure to apply at least some Dual Mode Detune as it will improve the sound considerably. With no detuning at all, Dual Mode Patches can sound synthetic and mechanical – even a slight amount will be effective, even for Patches where you don't want an obvious detuning effect.



We recommend you always add some Dual Mode Detune for Dual Mode wave Patches to avoid a sterile, mechanical sound. Add a little Dual Mode Detune even for a non-Dual Mode Patch so if you choose to switch on Dual Mode later, the Patch is 'Dual Mode Ready'.

Dual Mode can have a significant improving effect on many types of sound. If you're looking to simply add stereo width or movement to a sound, consider using the Chorus/Flanger module in the Part's Effects Unit with increased Effect Mix and feedback values to achieve this. On the other hand, Dual Mode will often add substantial depth and presence that can't be achieved purely with effects.

A particularly interesting use of Dual Mode is combining it with stereo LFOs. When modulated by a stereo LFO, each of the two voices in a Dual Mode configuration will have different phases (either random, antiphase or quadrature depending on the LFO mode). This can produce some incredibly animated stereo effects as the phasing will be different for each side of the stereo image.



Remember to reduce the Patch Level when you switch on Dual Mode as you've effectively added 3dB (doubled) the signal level. Failing to account for the increased level will make the Patch sound louder than other Patches and can cause the limiters to kick in.

## No Unison Mode?

Kyra's Dual Mode uses special algorithms to provide more flexibility than simple unison.



Unison is simply playing the a sound stacked up with an exact copy of itself, perhaps with some detuning.

Kyra doesn't offer a polyphony-robbing unison mode as there's really no need for it with up to 20 sound sources per note in Dual Mode combined with extensive detuning capabilities. If you feel the need to stack more sounds up, layer Patches in a Multi. Layering is far more flexible than unison as the Patches loaded into the component Parts of the layer need not be the same. They can also have separate levels, effects, detuning and stereo positioning. In a live gig setting, you can recall layered Patches just as easily as regular Patches by using a Multi. Check out some of the factory Multis to see what can be achieved by layering on Kyra.

## Filters

Once the sound sources in the two Oscillator Groups (or the Hypersaw) are mixed together, they are passed to the Kyra's Filter section. Kyra has one filter per voice by default but when Dual Mode is enabled, two independent filters, configured in parallel (one per Oscillator Group or Partial Group in Hypersaw Mode), become available.

Kyra's Filters are accurate emulations of the classic ladder designs found on many vintage analogue synthesizers. Kyra's Filters are oversampled at 96kHz so sound clear and alias-free and can be swept right across the full audio range even with high resonance settings. The Filters have six configurations offering low pass, band pass, high pass each with 2-pole (12dB/octave) and 4-pole (24dB/octave) responses. Each configuration sounds radically different and will impart distinctive sonic characteristics on the sound from the Oscillator Groups.



Take the time to get familiar with the six different filter types offered by Kyra. They each offer distinctly different sounds. Once you've mastered that, learn how to use the various modulation possibilities to create dynamic filter effects.

The type and configuration of a synthesizer's filters very much determine its 'signature'. Kyra's Filters have a dis-

tinctive sound best characterised as full and rich for the two pole filters, sharp and acidic for the four pole filters.

There is also an additional per-Part Formant Filter in the EQ module to impart vocal effects onto Patches. You can also use the EQ module in the Part effects to further shape the sound. These filters are detailed in the Effects section.



Experiment to discover ways of combining Kyra's Filters with the Effects Units. The EQ, Formant Filter and Phaser are particularly good companions to the Filters.

## Mixers

Kyra has four hardware mixer units. Each of them serves a different purpose and having a good knowledge of their location and purpose is important for effective programming. All the mixers except the Output Mixer can be modulated.

### Source Mixers

The **Source Mixers** mix the oscillator sources for each of the two Oscillator Groups as required - whether manually as level controls or by means of a modulator. The mixer is applied per note, so the relative balance of each oscillator can be different on a per-note basis, e.g. in response to note velocity. The mixers shown in the voice architecture diagrams are the Source Mixers.

### Input Mixer

The **Input Mixer** fulfils the role of the VCA (voltage controlled amplifier) in a traditional synthesizer. It controls the level of each note in response to a modulator such as an envelope generator or LFO. The Input Mixer takes the mixed output from the Oscillator Groups (or two groups if Dual Voice is configured) and mixes the resulting output onto one of the stereo busses that represent Kyra's 8 Parts.

As a result, each note can be panned anywhere in the stereo field by means of a modulator.

### Part Mixer

The **Part Mixer** allows you to set the relative levels of the 8 Parts. Note that its design and location give it a different purpose to the level parameter in a Patch. The Part volume parameter sets the level for the Part post-effects. This means that changing the Part volume does not change the level of the signal going into the effects chain so the timbre of the sound does not change as it does when the Patch level is adjusted:

As its name implies, the Part Mixer is a component of the Part settings. Less obviously, it is also available as a Patch parameter - the Final Level parameter which is located in the Effects pages (Dynamics). Use Final Level to equalize the levels of Patches without affecting the timbre itself (as is the case with the Patch Level). The key is to remember that Patch Level and Patch Pan are pre-effects and Part Level (a Part parameter), Final Level (a Patch parameter) are post-effects.

### Output Mixer

The **Output Mixer** allocates each of Kyra's 8 Parts to one of the four stereo line outputs. Any number of Parts can be

assigned to each output but a Part itself can only be assigned to one output. If more than one Part is assigned to an output, they are mixed together. Note that the Output Mixer does not affect USB audio which is presented to the USB host as the original 8 stereo Parts from the Part Mixer.

Note that it is highly unusual but possible to overload the Output Mixer if several Parts are assigned to a single Output and the levels on those Parts are very high. If you hear clipping when routing multiple Parts to a single output, use the Part Mixer's levels to moderate the Part levels such that the relative levels are the same but the overall level is reduced. The **Master Volume** control will not solve clipping in the Output Mixer.

## Microtuning

### Overview

By default, Kyra plays notes according to the equal temperament tuning scale. This tuning is widely used in modern Western music and allows music to be played in any key. However, there are many alternative tunings and in other parts of the world and with music styles other than modern Western, these other tunings are used extensively. Kyra supports all tuning schemes by means of full keyboard tunability using the MIDI Tuning Standard (MTS). With MTS, Kyra can tune any key to any frequency to single cent resolution. This allows tuning schemes with octaves containing other than the 12 notes per octave of equal temperament tuning. Kyra supports fixed and dynamic re-tuning.

### MIDI Tuning Standard

Kyra supports two forms of MTS messages:

**Non-Realtime Bulk Dump:** These tune every key MIDI can play in a single message. This message is usually sent at the beginning of a song. As most tunings will only sound correct if played in a specific key (equal temperament's advantage is that it doesn't have this constraint), the song must be in the specified key to be correctly tuned.



Kyra will ignore a request to play MIDI note zero but it can (and must) be present in the MTS bulk dump message.

**Realtime Per-Key:** These messages tune individual keys in real time, as the song plays. This offers the most flexibility as the tunings can be changed during the song. **Hermode Tuning** is an example of a tuning that uses this. Your sequencer must support the tuning scheme for it to work.

Kyra maintains a single, global tuning scheme at any given time and does not store tuning information in non-volatile memory. Being global, the tuning configured applies to all notes on all Parts. Kyra defaults to equal temperament when the system is restarted. Some DAWs can handle the tuning messages automatically, others will require manual insertion of MIDI Tuning Standard messages in the song preroll in the form of a Non-Realtime Bulk Dump.

The only way to change the tuning is to replace it with another one. Restart Kyra to restore it to equal temperament tuning (or send it a bulk MTS of equal temperament).

### Other Tuning Parameters

Kyra's master tuning can be set using the System Configuration page to be in the range 430Hz to 450Hz in 1Hz

steps. This is a persistent global parameter that affects all parts and tunings.

Kyra also supports per-Part tuning. The Part Parameters allow cent-level tuning of a Part. Kyra recognises MIDI RPNS 0 and 1 so tuning can be configured by your DAW at the start of a song or in real time during the song.

### Further References

Microtuning is an advanced topic and support for real time tuning varies widely amongst the various DAW applications. Check the user manual of your DAW for microtuning and MTS support. Bulk tuning can be achieved with any software capable of sending MIDI SysEx messages. Check the user manual and FAQs for your DAW for more information. Microtuning is a fascinating topic; it opens up new possibilities for your compositions and is an essential tool for composers of classical and non-Western music. If you're new to alternative tunings, there is a wealth of information on the topic online to help you explore the topic further.



## Modulation Matrix

### Overview

As mentioned earlier, Kyra has a comprehensive set of hardwired modulation routes that take care of the bulk of routine modulation programming needs. However, there are a lot of possible modulation routes in the system and to address each one with a dedicated route would require hundreds, if not thousands, of options.

To simplify this Kyra offers the Modulation Matrix (Mod Matrix), a concept from vintage synthesizers where physical pins were inserted into arrays (the matrix) to wire modules together. On Kyra, these pins become menu options, but the concept is similar.

Use the Mod Matrix **Select** button to navigate the Mod Matrix features. Each press on the Mod Matrix **Select** button will display each of the six Mod Matrix channel pages in turn. There's two pages for each channel, one for the sources and another for the levels applied to each destination.

When looking at the Mod Matrix options, don't think that the hardwired modulators (also known as 'fixed mods') can be forgotten about as everything they can do Mod Matrix can do better. There are two problems with that.

The first is that using Mod Matrix to do what the hardwired modulators can do simply wastes Mod Matrix slots. There are six slots, but you can run out if you use slots on routings that can be had 'for free' using the hardwired mods.

The second, more interesting reason is that many of the hardwired modulators are themselves destinations for the Mod Matrix. For example, you could configure channel pressure (aftertouch) to adjust the amount of LFO1 routed to the oscillator pitch. You wouldn't be able to do that in the Mod Matrix alone as either the number of options would become overwhelming or the concept of feeding back into the Mod Matrix would be necessary and that makes life complicated. So, take the time to learn the fixed mods so you can use them for the basic tasks and learn how to use them as Mod Matrix Destinations. The sky really is the limit in terms of the modulation possibilities available with the Mod Matrix.



Understanding that hardwired modulators can be Mod Matrix destinations is key to mastering the Mod Matrix (and modulation in general) on Kyra.

## Structure

A Mod Matrix **route** consists of a modulation source a modulation destination (the sources and destinations are collectively referred to as **agents** in the user interface). Each Mod Matrix channel can have one source and up to 3 destinations. Each of these 18 routes has an amount value that can be positive or negative. For each destination, the final amount (positive or negative) is added to the currently configured value of the destination control. Note that it is added, it does not replace the destination value. For example, if you have a Patch where the filter is set to its maximum setting, adding more with the Mod Matrix will have no effect (but adding a negative value will). When configuring the Mod Matrix, you must be aware of the 'base' setting of a destination control in the Patch as the Mod Matrix output will be an offset from that value.



The output of the Mod Matrix is added to the configured value of a parameter along with any other modulations being applied. Once all these are added together, the final value is applied to the destination parameter.

The ordering of destinations in each channel is not relevant. A source can appear in more than one channel (e.g. if you want to use it for more than three routes) and a destination can appear in more than one route (even within a

channel). In that case, the total modulation value is determined by adding up all the routes, accounting for the fact some modulations can be negative. This can be useful if a single Mod Matrix route does not provide the range you want: simply add another identical route (by adding a second identical destination to the same source) and they will 'stack'.

## Modulation Sources

Kyra offers an extensive list of sources for the Mod Matrix. Most are MIDI controllers; the rest of the line-up is internal modulation sources such as LFOs and EGs. Note that some of the MIDI sources, such as pitch bend and pan, also have hardwired routes (e.g. to both Oscillator Group pitch for pitch bend and Part pan for the Pan control). Adding a Mod Matrix route does not affect or remove the hardwired route but it means you can 'overload' the controller to do other things.

Source	Description
Pitch bend	see Source name
Channel pressure	Keyboard Channel Pressure Data
Modulation wheel	see Source name (MIDI CC#1)
Breath controller	see Source name (MIDI CC#2)
MIDI CC 3	see Source name

Foot controller	see Source name (MIDI CC#4)
Data entry	see Source name (MIDI CC#6)
Balance	see Source name (MIDI CC#8)
MIDI CC 9	see Source name
Pan	see Source name (MIDI CC#10)
Expression	see Source name (MIDI CC#11)
MIDI CC 12	see Source name
MIDI CC 13	see Source name
MIDI CC 14	see Source name
MIDI CC 15	see Source name
MIDI CC 16	see Source name
MIDI CC 17	see Source name
MIDI CC 18	see Source name
MIDI CC 19	see Source name
Sustain pedal	MIDI Sustain pedal (CC# 64)
EG1	Amp Envelope Generator 1
EG2	Filter Envelope Generator 2
EG3	Aux Envelope Generator 3
LFO1 unipolar	see Source name
LFO1 bipolar	see Source name
LFO2 unipolar	see Source name
LFO2 bipolar	see Source name
LFO3 unipolar	see Source name

LFO3 bipolar	see Source name
On velocity	Velocity value
Random per note	Random value per note
MIDI note	MIDI Note number
Polyphonic Press.	Polyphonic Keyboard Pressure Data
Off Velocity	Release velocity value

 Remember you don't have to use modulation sources for their original purposes. With Kyra, if you want to wire the Pitch Bend wheel to the Sub Oscillator level, go ahead and do it. This is why there's an option to defeat the standard operation of the Pitch Bend controller by setting Pitch Bend amount to zero.

All sources are unipolar; they only cause positive **or** negative (not both) modulation on a destination. The only exception is the LFO sources which each appear twice as Mod Matrix sources – once as a unipolar source and once as a bipolar source.

 Take the time to learn when to use a unipolar and when to use a bipolar LFO routing. As an example, if you are modulating the pitch of an oscillator with an LFO, you'd want the average pitch to be that the oscillator to be configured for. The LFO would then apply modulation in both directions (sharp and flat). You'd use a bipolar routing for that. Note that hardwired LFO routings are always bipolar.

If a modulation route is set to be negative the effect of the modulation is inverted. For a unipolar source, the modulation will be completely negative. This is especially useful for EG sources.

### Modulation Destinations

Almost all Kyra's parameters are available as Mod Mat destinations.

Destination	Description
OSC1 tune	<- see destination name
OSC1 detune	<- see destination name
OSC1 wavetable OSC2 FM	<- see destination name
OSC1 LFO1 to pitch	<- see destination name
OSC1 LFO2 to pulse width	<- see destination name

OSC1 sawtooth level	<- see destination name
OSC1 wavetable level	<- see destination name
OSC1 pulse level	<- see destination name
OSC1 aux oscillator level	<- see destination name
OSC1 sub level	<- see destination name
OSC1 sub detune	<- see destination name
OSC1 pulse width	<- see destination name
OSC2 tune	<- see destination name
OSC2 detune	<- see destination name
OSC2 LFO1 to pitch	<- see destination name
OSC2 LFO2 to pulse width	<- see destination name
OSC2 sawtooth level	<- see destination name
OSC2 wavetable level	<- see destination name
OSC2 pulse level	<- see destination name
OSC2 sub level	<- see destination name
OSC2 sub detune	<- see destination name
OSC2 pulse width	<- see destination name
Hypersaw intensity	<- see destination name
Hypersaw spread	<- see destination name
Filter 1/2 balance	<- see destination name
Filter 1 cutoff frequency	<- see destination name
Filter 1 resonance	<- see destination name
Filter 1 EG1 to cutoff	<- see destination name

Filter 1 EG2 to cutoff	<- see destination name
Filter 1 LFO2 to cutoff	<- see destination name
Filter 2 cutoff frequency	<- see destination name
Filter 2 resonance	<- see destination name
Filter 2 EG1 to cutoff	<- see destination name
Filter 2 EG2 to cutoff	<- see destination name
Filter 2 LFO2 to cutoff	<- see destination name
VCA level (pre-effects)	<- see destination name
VCA pan	<- see destination name
VCA stereo width	<- see destination name
VCA LFO1 to amplifier	<- see destination name
VCA LFO2 to pan	<- see destination name
EG1 attack	<- see destination name
EG1 decay	<- see destination name
EG1 sustain	<- see destination name
EG1 release	<- see destination name
EG2 attack	<- see destination name
EG2 decay	<- see destination name
EG2 sustain	<- see destination name
EG2 release	<- see destination name
EG3 attack	<- see destination name
EG3 decay	<- see destination name
EG3 sustain	<- see destination name

EG3 release	<- see destination name
LFO1 speed	<- see destination name
LFO1 delay	<- see destination name
LFO2 speed	<- see destination name
LFO2 delay	<- see destination name
LFO3 speed	<- see destination name
DDL mix	<- see destination name
DDL delay	<- see destination name
DDL feedback	<- see destination name
Phaser mix	<- see destination name
Phaser feedback	<- see destination name
Phaser modulation rate	<- see destination name
Phaser modulation depth	<- see destination name
Phaser frequency	<- see destination name
Chorus mix	<- see destination name
Chorus delay	<- see destination name
Chorus feedback	<- see destination name
Chorus modulation rate	<- see destination name
Chorus modulation depth	<- see destination name
Reverb mix	<- see destination name
Reverb time	<- see destination name
Reverb damping	<- see destination name

Reverb darkness	<- see destination name
EQ mid gain	<- see destination name
EQ mid frequency	<- see destination name
Formant filter gain	<- see destination name
Formant filter tune	<- see destination name
Distortion mix	<- see destination name
Distortion drive	<- see destination name
Final level (post-effects)	<- see destination name
Dual Detune amount	<- see destination name

## Control Automation

All of Kyra's controls (rotary controls and buttons) that relate to Patch parameters can be automated. This allows your DAW to record any changes made to Patch parameters during a performance. When the sequence is played back, the controls will be updated exactly as they were during the original performance.

To enable control automation recording, enable Send Automation in the MIDI Configuration page. When enabled, any control related to a Patch parameter will send MIDI SysEx messages that can be recorded by your DAW (or control another connected Kyra).

Switch off Send Automation if you're not using it (it is off by default). The messages generated can occupy a significant amount of DIN MIDI bandwidth and memory in your DAW, especially for rotary controls. If you have recorded automation you no longer require (or it is incorrect), delete it in your DAW.

As automation uses MIDI SysEx messages, it is not possible to edit it in a DAW (other than the position of events). If you want editable automation, the best solution is to use MIDI Continuous Controllers (CCs). You can use the fixed CCs or for more flexibility, use the Mod Matrix to map CCs to the parameters you want to automate and then configure these on your master keyboard. The DAW can record

these and they will be editable in the DAW as they are standard MIDI messages rather than system exclusive messages. MIDI CCs use considerably less MIDI bandwidth than SysEx-based automation messages and can be used to update more than one Part at the same time. The use of MIDI CCs is recommended where possible. Kyra supports a wide range of fixed CCs (MIDI defined and extensions) and allows virtually limitless extensions via the Modulation Matrix.

Only Patch parameters can send automation. Part and System Configuration controls do not send automation messages - remember this includes transpose (a Part parameter) and Master Volume (a System Configuration parameter). Part parameters can be controlled via SysEx messages but do not send automation messages themselves.

Follow this checklist to ensure automation works correctly:

For automation recording:

- Enable Send Automation in the MIDI Configuration page and ensure the automation messages are configured to use the required MIDI port (DIN MIDI or USB).
- Select the Part you wish to automate.

- Adjust controls intended for automation to their default positions.
- Move the controls as required as the DAW records the messages (ideally, onto a separate automation track).
- Overdub with automation from any other Parts as required.

For automation playback, check that the Device ID in the MIDI Configuration page is the same as it was when the automation was recorded. There is no reason to change the Device ID unless you have more than one Kyra on a single DIN MIDI cable.

Use a Program Change message in the song preroll to set the automated parameters to their default values. If the Patch doesn't contain the correct defaults, edit the Patch or send automation messages in the song preroll (only the final message is required, the others can be deleted).

! We recommend the use of MIDI Continuous Controller and the Mod Matrix to solve your modulation requirements. Only resort to Control Automation if there is a specific need that can't be solved with MIDI CC and Mod Matrix automation.

! Control Automation can be useful for certain types of improvised music. Even so, we'd recommend using MIDI CCs and recording them from your master keyboard rather than from Kyra's controls using Control Automation.



# Troubleshooting

## Low Levels or Noise

As Kyra has such a large dynamic range, single Part playing will result in relatively low levels. These lower levels are necessary to ensure Kyra can output up to 128 notes over 8 Parts without using excessive compression. When playing single Part sounds, you might need to boost the input gain on your mixer or amplifier, this is normal. Check that the **Master Volume** control is at its maximum setting; this will ensure noise is minimised. Kyra has very high-quality components in its line outputs and significant noise (hiss) should not be evident if everything is set up correctly. If you find the need to turn the **Master Volume** control much below 100, consider turning down the trim on your mixer or the volume of your amplifier and turning up the **Master Volume** control to get similar levels.

For USB recordings, as the audio bit depth is 24 bits, boosting the level recorded is unlikely to result in significant degradation of the sound quality when normalising the recorded audio.

## Hum

A background hum indicates the likely presence of a ground loop in your overall system. Use headphones connected directly to Kyra to confirm the hum is not present at that output. Solving ground loops is very much dependent on the set up of your studio and is beyond the scope of this manual although removing connections in your setup (not just on Kyra) one at a time in your system is a good way to find out what is causing the hum. DIN MIDI can't form a ground loop but USB can, as can the line outputs if you have them connected to more than one piece of equipment (e.g. two amplifiers or mixers).

## Interference

The presence of digital static, interference or crackling on the line outputs is likely to be caused by faulty connections. Check that jack plugs are fully inserted and are in good condition. Try replacement leads and ensure they are balanced TRS types - balanced connections considerably increase tolerance of interference. Ensure Kyra is connected to balanced line inputs. Don't use microphone, phono or guitar inputs on your amplifier, mixer or soundcard. Some mixers and soundcards have switchable inputs - ensure the switch is in the balanced line level input setting. Check nothing near Kyra or the leads to your mixer is

causing interference; mobile phones are a possible source of interference and have no place in a studio.

If you're recording via a sound card, check it is of good quality. Built in (on motherboard), old and/or low cost soundcard interfaces won't have quality balanced inputs and are unlikely to yield good results.

### No Output

There are a few reasons why there might be no output. A good check is to insert headphones directly into Kyra's headphone jack. If audio is present there, the problem is likely to be with the line output leads or your mixer/soundcard. If audio isn't present, check:

- The **Main Volume** control is turned up
- Your master keyboard is configured correctly and transmitting on the correct channel. Check MIDI is being received by looking at the MIDI indicator on Kyra's Home page.
- The Part Output is set to the outputs you have connected and that the Part Volume is correct. Remember that if you're listening on headphones plugged directly into Kyra's headphones output, you will only hear Parts assigned to Output A.

- Soundcard mode is disabled so that instrument audio is routed to Output A rather than USB audio.

### Distortion

If the sound is distorted, first check if this is a feature of the selected Patch. It is possible to add intentional distortion to a Patch by a variety of means so be sure to check this first.

Next, check that the level of the Patch isn't too high. If a Patch level is too high, the limiters will kick in and cause saturation and compression of the sound, especially when loud block chords are played. If this is not what you want, reduce the level of the Patch.

It is unusual but possible to get distortion on the line outputs (including the headphone output which is simply a mirror of Output A) if more than one Part is sent to a single output and the Parts themselves are very loud. This would be heard as crackling or clipping. If this is happening, reduce the Part Volumes (in the Multi Edit page). As you add more Parts to your composition, it is good practice to review and remix the Part volumes and reduce them to rebalance the overall volume rather than reducing the volume on your mixer (or Kyra's headphones output) to compensate. This will avoid the risk of any distortion.

Using more than one of line outputs reduces the risk too as fewer Parts are being mixed onto a single output. As the USB output streams are not mixed, this risk does not exist for the USB streams.

This small risk of distortion is a design compromise to ensure a good dynamic range is available but without individual Parts having excessively low levels. On the other hand, Kyra seeks to avoid excessive compression. As a result, it is essential to manage levels as described above to avoid distortion occurring.

### Missing Notes

There are several reasons why notes may appear to be missing when you play back a song:

- The envelope of the sound is such that the note is released before it can be heard. In other words, the note is too short to be heard for the configured envelope.
- The note is cut off by a repeat of the same note at a lower velocity. This is the most common cause of perceived missing notes.
- A modulator is modifying some parameter that reduces the level of the note.
- The note off event was received before the note on event. This can happen unexpectedly – in particular, if

you use a step editor to create a sequence of the same note and quantize the notes back to back, sequencers occasionally will send the MIDI note on event of one note before the note off event of the previous one. As Kyra can only play one instance of a note on a given Part, this will result in the note not being heard. To fix this, shorten the event so there is a definite gap between the end of the note and the start of the next 'hit' of the same note.

- Two notes are playing with opposite or near-opposite phase. If two notes play such that their phases are opposite, they will sound much quieter or not sound at all. This can happen when identical notes are played (on different Parts) with hard quantization. To fix this, add slight randomization to the start times. Detuning or using a different sound is another strategy. This problem can also occur with Dual Mode sounds.
- Kyra is running out of voices on a Part. Kyra can sound up to 32 notes per Part – if this is exceeded, the oldest note sounding will be cut off to play the latest one requested. There's also an overall limit of 128 for all the Parts; if this is exceeded, new note requests will be ignored. You're unlikely to hit these limits but be aware of it. Remember that Dual Mode and Dual Filter Patches use two voice channels per note played.

- MIDI events are getting lost. Check the quality and length of the cables (USB or DIN MIDI). Try alternative cables. Reboot your computer to check if that resolves the problem.

### Stuck Notes

Notes that seem to be 'stuck' is almost certainly a sign that MIDI data is being lost or corrupted. Check your cables and MIDI drivers. Check that your controllers are not sending contradictory MIDI data on the USB and DIN MIDI ports. Stuck notes can be stopped by changing the Patch on the front panel.

### Timing Problems

There are several reasons why your compositions might have individual notes, sequences of notes or whole tracks/songs that appear to be playing out of time. This would usually manifest itself as the audio from Kyra being 'behind the beat'.

Your composition is too complex for MIDI. This primarily relates to the DIN MIDI interface. MIDI was developed in the early 80s and is a low speed interface. It is not capable of complex, highly quantized compositions with lots of real-time controller updates. The result of this is timing problems or lost events in your tracks. The solution is to

either simplify your composition or to use USB MIDI which operates considerably faster than DIN MIDI on Kyra. Note that sending SysEx messages during a song is not recommended, especially if using DIN MIDI.

If you're feeding Kyra's audio back into your DAW and have other tracks using VST instruments or other instruments, you will need to adjust the settings on your DAW to match these. This is referred to **Delay Compensation**. Kyra is extremely responsive to MIDI but you must account for the delay between the MIDI note play being sent by your DAW and the audio being received back at your DAW. The audio itself, whether via the stereo line outs or via USB, must be received by your computer and this also takes time. With a fast computer, USB MIDI and USB audio, you should be able to achieve a 'round-trip' latency of 5-20 ms. If it's more than that, check the settings and performance of your computer. If it's less than that, you can either ignore it or use your DAW's Delay Compensation settings to eliminate it completely (it isn't actually eliminated, the MIDI events are just sent by your DAW slightly earlier so that the audio is received back at the correct time but the result is the audio is spot on the beat). The impact of the latency depends on the type of music and your tolerance of timing latency but the important fact is that providing your system is configured correctly, you can eliminate it completely. Please refer to the manual of your DAW on how to configure Delay Compensation. Once con-

figured, you should be able to forget about it. Delay Compensation does not apply to live play (when you are listening to audio via the DAW as you play it) but if your system is configured correctly and performing well, the latency will be so low as to be not noticeable).

If you are using USB MIDI and/or audio, connect Kyra directly to your computer. Do not use hubs. They are often non-compliant and will introduce additional latency and other problems. Use good quality cables.



The line outputs are still active when you use USB audio but we recommend you don't use the line outputs when you're using USB audio, except in the case of Soundcard audio from Output A. This is due to the fact there may be a slight delay between the USB audio and the line outputs.

# Kyra USB Interface

## USB Audio

In addition to the stereo line outputs, Kyra streams each of its 8 stereo Parts over USB as 'virtual' connections to the host DAW (Digital Audio Workstation). The Output Mixer is not used for USB audio (but remains functional for the line outputs) and each Part is streamed independently directly from its Part without any further mixing or processing.

Any mixing required can be done in your DAW. Like the line outputs, Kyra's USB audio runs at the native 96kHz audio format to ensure the highest possible quality audio is available to your DAW. You can also select 48 kHz audio by configuring your DAW for 48 kHz operation. Note that the 48kHz downsampling only affects USB audio. Kyra's internal processing and the line outputs always run at 96 kHz. At either sample rate, the bit depth of the audio is 24 bits.

You can of course resample the audio in your DAW as part of the final mixdown of your song, e.g. if you are mixing down for mastering a CD at 44.1 kHz. Note that Kyra can't stream at 44.1 kHz, only 48 kHz and 96 kHz are available. If you are mastering for CD, run your project at 48 kHz or

better still, 96kHz and resample to 44.1 kHz when you produce your final master.



We recommend you stream Kyra's USB audio at 96kHz 24 bit and only resample when you produce your final mixdown for mastering. Consider 48kHz only if your DAW is not fast enough to accommodate 96kHz audio.

As Kyra has a USB 2.0 port with a capacity of 480 Mbits/sec, there are no inherent constraints on audio streaming as was often the case on synthesizers using the older USB 1.x specifications (referred to as 'low speed' and 'full speed'). Check that your computer has the specifications necessary to support the high data rates involved. Note that Kyra does not support legacy USB 1.1 (for audio or MIDI); a USB 2.0 or above compatible USB port is required.



Kyra will not connect to a low speed or full speed USB 1.x port.

Remember that the **Master Volume** control does not affect USB audio. Use Part Levels or controls on your DAW to do any necessary mixing and levels management.

You can check the sample rate Kyra is running at in the System Configuration pages.

## USB MIDI

MIDI commands and data can be sent and received via USB MIDI as well as the DIN MIDI connectors.

! We recommend you use USB MIDI rather than DIN MIDI. It's much faster and requires fewer cables.

## USB Installation

Kyra's USB implementation supports Windows 7 onwards as well as macOS onwards. MacOS users do not need to install a driver but until Windows supports USB Audio Class 2.0 (UAC2), Windows users must install the provided driver before using the USB connection; install the driver before connecting the USB port for the first time. It is important to ensure your computer operating system is updated with the latest service packs and updates before installing the driver.

Once installed, Kyra should appear as a single device with 16 audio channels - configure the routings in your DAW to route the channels to 8 stereo sources - refer to the user manual of your DAW for directions on how to achieve this as it will depend on which DAW you are using. The channel allocations are for 8 stereo pairs in order, left then right; for example, source channel 0 is the left channel of Part 1,

source channel 1 is the right channel of Part 1, source channel 2 is the left channel of Part 1, etc.

! You should only need to configure the USB audio mappings once in your DAW. Please refer to the manual for your DAW on how to do this mapping. Remember to include mappings for the return (Soundcard) channel.

In addition to the audio sources, a Kyra MIDI In and a Kyra MIDI Out port should also appear on your computer's MIDI device list.

Avoid inserting or removing the USB cable whilst the synthesizer is operating. Reconfigure cables when your computer and Kyra are all switched off. Note that most DAWs will not resume MIDI transfers if the USB cable is replaced; you might need to restart the application if the cable is unplugged or Kyra is restarted.

Please plug Kyra directly into a USB socket on your computer - do not use USB hubs. The worst hubs are those built into monitors. These are designed for low-performance peripherals such as mice and keyboards. Many stand-alone hubs do not implement USB correctly.

! Plug Kyra directly into a USB 2.0 or above port on your computer. Avoid using hubs.

## USB Troubleshooting

Kyra implements USB Audio Class 2.0 (UAC2) with ASIO support to achieve extremely low latency. Low latency (the time between key presses and sound) is important to most musicians. Most DAW applications have settings to configure the audio, usually in the form of buffer sizes. Smaller buffers mean lower latencies but increase the demands on your computer's performance. You'll need to experiment to get the right setting but it is a given that you should be using a powerful computer with fast disks and plenty memory if you want the absolute lowest latencies. Remember that Kyra is streaming 16 channels (8 stereo pairs) of 24-bit audio at up to 96kHz to your computer - that is a lot of data and puts significant demands on your computer.

⚠ Kyra always streams all 8 stereo pairs regardless of how many streams you're actually using.

If your computer isn't fast enough for the audio configuration you are using, you may hear clicks, pops or delays on the USB audio. If this occurs, review your DAW buffer settings. Other factors can cause audio defects including buggy USB drivers, low quality cables, low quality USB hubs and the hard disk in your computer being too slow to keep up, especially once you start multi-track record and

playback. SSDs (solid state drives) are an ideal solution for the 'scratch disk' for your DAW's audio.

When using USB audio with Kyra, avoid running other applications on your computer whilst you are using your DAW. Seemingly innocuous applications such as browsers, instant messaging tools and office applications can tie up CPU cycles and the hard disk to the point of interrupting audio. It is good practice to dedicate your DAW computer entirely to audio and use a different computer for everything else. Within the DAW itself, check that your plug-ins are not soaking up excessive CPU load (most DAWs have a load indicator).

Laptop computers tend to have slower CPUs, hard disks and memory than desktop computers, especially when running on battery power. Low latency multi track recording in a DAW on a laptop will need a very high specification model. Laptop users should have their computer connected to mains power. On the plus side, having Kyra in your setup removes a considerable amount of loading from your computer as you'll have far less need to run CPU-heavy software synthesizers and effects.

If your computer is not sufficiently powerful to handle Kyra's USB audio stream (which is likely to be the case if you can't get perfect audio with satisfactory latency), consider using the line outputs instead of USB audio. With



a good quality mixer, Kyra's four stereo outputs will sound just as good as USB audio.

### ASIO

Kyra's USB driver is ASIO compliant. ASIO provides for ultra-low latency capability allowing you to route studio quality audio via USB and not get any discernible latency between playing notes and hearing them (subject to the performance of your computer).

Note that it is a limitation of ASIO that an application (e.g. a DAW) can only load one ASIO driver at any given time. To solve this, Kyra has a 'Soundcard' mode which will accept a single stereo audio feed from your DAW and route it out via Output A (and correspondingly, the headphone output). ASIO will not allow you to load a second driver for a soundcard on your computer although there are work-around solutions such as asio4all for Windows users. You can find the Soundcard Mode option in the first System Edit page – switch this to Enabled to route audio from your DAW to Output A. This will replace the synthesizer audio currently assigned to Output A.

The use of non-ASIO compliant sound interfaces and applications for analogue input or playback (e.g. most on-board sound cards) is not recommended. They are highly unlikely to support low latency, high quality audio playback.



ASIO is only relevant to Windows users. Kyra is compatible with macOS CoreAudio without the need to install any additional drivers.

# Kyra Firmware Update

Kyra has a user-friendly feature that makes it possible to update the firmware software easily.

Firmware updates can be easily done with our free **Kyra Manager** application. The fastest way to get this application is by downloading it from our website at:

<http://www.waldorfmusic.com/kyra>

⚠ Download the **Kyra Manager** software for your operation system (Windows or macOS).



To update Kyra’s firmware software:

- Connect Kyra to your computer. You can use DIN MIDI (please connect MIDI In and Out to your computer MIDI interface) or USB MIDI. We strongly recommend to use USB MIDI. Do not use a USB hub for connection.

⚠ Keep in mind to install the Windows USB driver before using Kyra’s USB port with a Windows operating system.

- Make sure that your computer has an active internet connection.
- Start the Kyra Manager application. On the left side of the application window the checklist guides you through the firmware update process.
- Start with **Step 1** and confirm every step. Make sure to set up the correct MIDI connection within the software. This is important in case you use more than one Kyra within your setup.
- With the last step, the firmware update finally starts.
- The application shows a progress bar. Kyra will either restart or shutdown after the update.

⚠ **Do not under any circumstances turn off Kyra while the update step is in progress.**

# Technical Data

## Power Supply

Supply Voltage Power: 100 – 240 V AC  
 Supply Voltage Kyra: 12 V DC  
 Maximum power consumption: 9.5 W

## Dimensions and Weight

Width: 440 mm  
 Depth: 305 mm  
 Height (including knobs): 85 mm  
 Total weight: 5.7 kg

## Kyra Factory Bank List

Bank Name	Description
A RAM	Selection 1 Best of Factory
B RAM	Selection 2 Best of Factory
C RAM	Factory 1
D RAM	Factory 2
E RAM	Factory 3
F RAM	Factory 4
G RAM	Empty bank for storing own patches
H ROM	Selection 1 Best of Factory
I ROM	Selection 2 Best of Factory
J ROM	Factory 1
K ROM	Factory 2
L ROM	Factory 3
M ROM	Factory 4
N ROM	Factory 5
O ROM	Factory 6
P ROM	Factory 7
Q ROM	Factory 8

# Glossary

## Aliasing

A type of distortion specific to digital audio systems when a sound contains components that exceed half the sample rate (also known as the 'Nyquist Rate'). The result is a nasty, metallic noise that varies unpleasantly with pitch. Regardless of any marketing claims otherwise, it is not possible to remove aliasing once it has occurred. Kyra uses several techniques to mitigate aliasing, the main one being the use of massive oversampling.

## Antiphase LFO

A special setting for a Kyra LFO such that the LFO's output is inverted (180 degrees out of phase) before it is applied to the specified modulation target of the second voice of a Dual Mode note.

## Arpeggiator

A phrase-playing unit that allows sequential playing of notes played as a block chord on a keyboard.

## ASIO

Audio Stream Input/Output. An audio interface driver protocol for Windows audio specified by Steinberg. Allows low-latency direct access to audio hardware.

## Attack

The first of the four segments in an ADSR-style envelope generator. Faster attacks are associated with more percussive sounds and slower attacks with gentler pads and string type sounds. The attack segment starts when a key is pressed. If a note is retriggered, the attack phase will start at the existing level of the note rather than at zero.

## Automation

The technique of controlling parameters using an external controller, typically a sequencer. On Kyra, this can be done with continuous controllers via the Mod Matrix or by recording Systems Exclusive messages sent by the physical controls.

## Balanced

A balanced cable carries a single signal along two conductors each with opposite polarity. This allows the receiver to remove most of the noise induced by the cable by subtracting the signal from one conductor from the other. Kyra features balanced line outputs and you should use

balanced cables and a balanced input on your mixer or sound card to obtain the best results, especially if the cables are long. You can use unbalanced connectors and inputs but you will lose the noise immunity offered by balanced connections.

### **Bank**

A collection of 128 Patches. Patches are usually organised into Banks of 128 to match the MIDI specification that originally supported just 128 Patches. As synthesizers became able to store more than 128 Patches, Patches were grouped into Banks. Kyra supports 26 Banks of Patches labelled A to Z. The instrument supports MIDI Bank Select messages to allow the DAW/Sequencer to select Patches from any of the 26 Banks. The current Bank can also be set on the front panel using the Bank select buttons.

### **Bank Select**

A MIDI message to allow MIDI selection beyond 128 patches (or 'programs' in MIDI-speak). Using Bank Select is a two-step process whereby the Bank Select message is sent first and then Program Changes after that will select from the Bank previously selected. Note that per MIDI specifications, a Bank Select message does not cause the Patch to change, only the subsequent MIDI Program Change message does that and when it does, it uses the Bank selected from the previous Bank Select message.

### **Battery**

Kyra has an internal rechargeable battery that maintains Patch, Multi and Configuration data when the system is switched off at the mains. The battery is charged up whenever mains is applied. A full charge, which is achieved after a few hours of mains being connected, should last several months but note that the system will lose settings (including RAM patches) if the battery goes flat. To avoid this, ensure you plug the synthesizer into the mains at least for a few hours each month; ideally leave it plugged in all the time and in standby mode. If you're planning to store the synthesizer for an extended period without power, it makes sense to back up all your Patches and Multis before doing so.

### **BPM**

Beats per Minute. Kyra's arpeggiator is calibrated in BPM to allow it to be manually matched to the tempo of a song (typically in a live set). In a studio environment, if the arpeggiator is used, it would normally be set to synchronise to a MIDI clock. In that way, the arpeggiator will always be in sync with the song even if the song tempo changes.

## **Cent**

A very fine pitch interval representing 100th of a semitone. A cent is the finest interval Kyra can tune its oscillators to and is generally regarded as being finer than a human can discern.

## **Channel Pressure**

Also referred to as Aftertouch. Channel pressure is a MIDI feature to allow MIDI keyboards to respond to pressure. Unlike Polyphonic Pressure, the pressure is per channel rather than per note. Most MIDI keyboards can generate channel pressure information. Kyra can receive channel pressure information and routes it into the Mod Matrix where it can be used to modulate any destination. Channel pressure can also be added in most DAWs.

## **Chorus**

A modulated delay-based effect that gives the impression multiple instruments are playing at once. When used in moderation, it can give an otherwise flat sound a wonderful, airy feel. The Chorus/Flanger module on each Part can be configured to provide this.

## **Clipping**

A type of distortion that occurs when a signal reaches its maximum excursion and is hard limited (clipped). The

result is an unpleasant clicking, buzzing or cracking sound. Clipping is rare but possible on Kyra. Typically, it can only occur if excessively loud Parts are mixed together onto the same analogue output.

## **Coarse Tune**

The ability to tune an oscillator over a wide range, typically at least one octave. Kyra offers coarse tuning in semitone steps (in addition to detuning in sub-cent steps) up to two octaves above and below the root note.

## **Contention**

Contention is the situation that occurs when there are shared resources in a system and a request is made that exceeds the availability of those resources. Different systems handle this in different ways but in many synthesizers, it manifests itself as loss of polyphony or gaps in sounds. Kyra was designed to be completely contention free as all sound generation is done by dedicated hardware rather than best-effort software running on a generic processor. As a result, Kyra has no contention and the system will operate 100% accurately right up until it reaches its maximum capacity of 128 notes (or 32 notes in each Part). At that point, further notes will either displace older notes (Part) or not play at all (128 notes reached).

### **Continuous Controller**

A feature of MIDI to allow channel-based continuous parameters to be adjusted. Kyra responds to a defined set of standard MIDI continuous controllers (CCs). In addition to these standard CCs, Kyra offers additional fixed routings (specifically, for Filter settings) as well as several additional controllers into the Mod Matrix to allow custom configurations.

### **Comb Filter**

A delay-based effect that uses very short delay times (as little as a few samples) and feedback combined with modulation to provide a characteristic hollow tube-like sound particularly for percussive sounds. Even though this is a delay effect the delay times are far too short for distinct echoes to be discerned. The Chorus/Flanger module on each Part can be configured to provide this effect and includes a dedicated LFO to provide modulation of the effect.

### **Cutoff Frequency**

The frequency at which a filter transitions from its passband to its stopband. The Cutoff Frequency is often modulated and combined with resonance to provide dynamic sounds.

### **DAC**

Digital-to-Analogue Converter. The DAC converts the digital audio into analogue audio such that it can be mixed using an analogue mixer and rendered by an amplifier. Kyra features a high-quality 32-bit stereo DAC running at 96kHz for studio quality sound.

### **Daisy Chain**

A feature of DIN MIDI where you can connect devices in series using the MIDI Thru connector. As Kyra responds to up to 8 MIDI Channels, you can daisy chain two Kyras on a single DIN MIDI port and have individual control over all 16 Parts. You can also daisy chain a different unit such as a drum machine or a MIDI mixer. Please avoid chaining more than two devices on a single MIDI connector otherwise timing can be affected. Daisy chaining does not apply to USB MIDI.

### **Damping**

The use of a low-pass filter in the feedback chain of an effect so that the residual sound loses high frequency content over time.

### **Digital Delay Line (DDL)**

An emulation of the classic delay line that adds echoes (repeats) of the original sound that decays over time.

Kyra's DDL can be used to achieve special effects or complex rhythmic effects on percussive sounds. Kyra provides a delay module on each Part capable of providing delays up to 2.7 seconds and the delay time can be synchronised to a MIDI clock so it follows the tempo of your song accurately.

### **DAW**

Digital Audio Workstation. A Sequencer that can record, process and replay digital audio as well as MIDI information. Kyra offers a USB 2.0 connection for complete DAW integration.

### **Decay**

The second of the four segments in an ADSR-style envelope generator. The decay segment starts when the attack segment completes (reaches full amplitude) and ends when the sustain level is reached.

### **Defeat**

A term used to describe an effect that has been bypassed.

### **Delay Compensation**

A feature of most DAWs that ensures the audio from hardware instruments, including Kyra, and software (virtual) instruments are in perfect time synchronisation. If

you find audio from Kyra is out of sync with your software instruments, find out how to adjust the delay compensation on your DAW.

### **Detune**

The technique of varying the pitch interval between two oscillators by a relatively small amount (typically just a few cents). Two oscillators playing the same pitch will sound flat and hollow (and in fact may cancel out completely). Just a few cents of detune will provide a rich, animated effect. Synonymous with Fine Tuning.

### **Distortion**

A modification, desired or undesired, of a sound. Many things can cause undesired distortion but excessive levels are usually the culprit. Closely related to dynamic range and resolution. On the other hand, desired distortion can add character to a sound making it sound 'grittier'.

Kyra offers a dedicated distortion module on each Part that uses waveshapers and filters to add considerable extra harmonics to a sound.

### **Doubling**

A delay-type effect that uses delays in the order of 80-150mS to provide a thickening effect whereby the echo can just be discerned as distinct. The Chorus/Flanger module



on each Part can be configured to do this without tying up the main Digital Delay module.

### **Dry**

The component of a signal that has not been processed by an effect. The component of a signal that has been processed by an effect is referred to as the 'wet' signal.

### **DSP**

Digital Signal Processing or Digital Signal Processor. The use of discrete time signal processing to provide audio synthesis and effects. Kyra uses Digital Signal Processing but not traditional Digital Signal Processors as they are not able to provide the contention-free performance required.

### **Dual Mode**

A feature on Kyra that allows two hardware voices to be used to generate a stereo note. This can be applied to Wave and Hypersaw Mode Patches. Dual Mode is the only feature of Kyra that reduces its polyphony.

### **Dynamic Range**

The ability of an audio system to represent and handle a range of sounds from the quietest to the loudest without undesired distortion. A limited dynamic range will mean quieter sounds can be noisy and louder sounds suffer

distortion or clipping. A larger dynamic range provides for a larger range of levels without sacrificing audio quality due to excessive compression.

### **Effects**

Often shorted to 'FX'. These are algorithms used to alter and shape sounds, usually towards the end of the signal chain. Kyra offers Limiters, EQ, Digital Delay, Distortion, Phaser, Chorus/Flanger) and Reverberation modules in its effects chain. Each Part has its own independent FX unit which means a Patch will always sound the same regardless of which Part it is loaded into (assuming no outboard processing).

### **EG**

Short for Envelope Generator. A modulator used to achieve evolving modulation effects, most commonly using an amplifier to give a sound its own amplitude contour.

### **EQ**

Short for Equalization or Equalizer. A process used to shape the sound by cutting or boosting selected ranges of frequencies. Kyra supports a 3-band shelving EQ with a full range sweepable mid with adjustable Q on each of its 8 Parts.

## **Equal Temperament**

A tuning method whereby the ratio between any two adjacent notes is the twelfth root of two. By default, Kyra plays Equal Temperament tuning but it can be configured to play any tuning by means of MIDI Tuning Standard messages.

## **Filter**

A sound processor that attenuates certain frequencies to achieve a certain effect. Depending on the filter settings, filters can boost frequencies around the cutoff point.

## **Flanger**

An effect that uses relatively short delays and large amounts of feedback to generate a characteristic whooshing sound. The delay period can be modulated to obtain the whooshing effect. The Chorus/Flanger module in the Effects Unit on each Part can be configured to provide this.

## **FM**

Frequency Modulation. A technique of using one oscillator to modulate the frequency of another to provide distinctive extra harmonics. A useful technique but it can be very difficult to predict what the sound will be in advance and good settings are often more a matter of trial and error rather than by design. For this reason, pure FM synthesis

has fallen out of favour in recent years but it still has its uses; certain sounds are very hard to achieve using other techniques. Kyra supports FM between its two Oscillator Groups. Kyra also has a large wavetable bank of pre-made FM shapes that can achieve many of the sounds true FM can deliver without the complexity of configuring it.

## **Follow Mode**

A feature of Kyra that causes the OLED display to represent (follow) the control being manipulated by the user. Engaging follow mode provides useful feedback as to the current setting of a parameter. However, at times, it's distracting to have the display switch when a control is changed so Kyra allows follow mode to be switched off using the Follow Mode button.

## **Formant**

A grouping of harmonics (tonal components) that characterises a sound.

## **Formant Filter**

A filter intended to impart vocal characteristics on a sound. Kyra features a Formant Filter within each of the Part Effect units.

## **FPGA**

Field-Programmable Gate Array. A type of integrated circuit that can be dynamically configured to perform specialist operations, usually with massive parallelism. Kyra is based on an FPGA.

## **Front Panel**

The assembly containing the OLED display, rotary controls, push buttons and LEDs. The Front Panel has its own processor which can be updated as part of the Software Update.

## **FX**

Shorthand for 'effects'.

## **Gate Length**

The interval over which a note is held by an Arpeggiator, specified as a percentage of the configured beat length.

## **Hard Sync**

An effect whereby one oscillator is phase locked to another. It is very useful to achieve tonal variation on wavetable-based sounds.

## **Hot**

An unusually large audio signal that has the potential to cause distortion.

## **Humanising**

The practice of making music sound like it is being performed by human musicians rather than computers. This usually involves subtle randomization of timing, pitch and loudness of notes and beats. Kyra provides Mod Matrix agents (particularly the 'Random per Note' source) to help with this and most DAWs offer timing variation features.

## **Hypersaw**

A sound generation technique using banks of oscillators generating harmonically-rich sawtooth waves (referred to as 'partials') tuned and balanced according to a configurable algorithm. The result is a very rich, animated and powerful sound useful for a wide range of uses. The beauty of the hypersaw, in addition to its wonderful sound, is that it is very simple to configure as there's only two parameters, Intensity and Spread. The algorithm used, and the quality and number of the oscillators determines the quality of the hypersaw. Kyra's hypersaw consists of six partials by standard but this can be doubled to twelve by using Dual Mode.

## **Latency**

A delay, always undesired, between an action and its corresponding effect. Low latency in audio systems is especially critical when live playing by a human is involved as any significant latency between keyboard action and hearing the sound is highly detrimental to the whole experience.

Many factors contribute towards the total latency. Kyra features exceptionally low latency due to the custom hardware it has for MIDI processing and sound generation but poor configuration of your computer or the software running on it, or poor performance of the computer itself, can result in the overall latency being unsatisfactory.

## **Legato**

A style of playing whereby the next note is played before the previous one is released. On Kyra, only notes played legato whilst in Mono key mode will sound with portamento.

## **Limitter**

A process to limit the dynamic range of a signal in a musical way. Kyra hosts two Limiters on each Part. The first is located after the EQ module and before the Distortion module in the effects chain and has three programmable

settings. The second is located at the final Part output and has a fixed configuration.

## **LFO**

Low frequency oscillator. An oscillator with sub-sonic frequency (typically below 20Hz) used to provide modulation effects. Kyra has a total of 6 distinct LFOs, three for general synthesis and three in the effects section.

## **Master Tuning**

The reference pitch to which instruments playing together are tuned. Kyra allows its pitch to be set such that the A above middle C is in the range 430 to 450Hz. This is the instrument's root tuning to which all other pitch offsets are relative to, even if microtuning is used. The default setting is 440Hz.

## **Microtuning**

Microtuning is the ability of a synthesizer to individually tune each note to a frequency other than that defined by the default equal temperament tuning. This allows the instrument to play in tuning schemes other than equal temperament. Kyra supports global (all Parts) full keyboard microtuning by means of the MIDI Tuning Standard (MTS) for real time and non-realtime (bulk) updates.

## **MIDI**

Musical Instrument Digital Interface. A long-established standard and protocol developed specifically for musical instruments and related equipment to allow exchange of data between instruments and controllers (DAW, Sequencer). Kyra supports MIDI via DIN MIDI connectors (the traditional 5 pin jacks) as well as via high speed USB.

## **MIDI Clock**

A feature of MIDI to allow time-synchronised playback of event sequences on connected systems. MIDI clock does not relay positional information though and must be used with other messages to ensure play occurs at the right place as well as the right tempo. Kyra is able to lock its arpeggiator, DDL and LFOs to MIDI clock. You must ensure your master device (a sequencer, drum machine etc.) is configured to transmit MIDI clock before this can work; it is usually off by default as it uses valuable MIDI bandwidth.

## **Modulator**

A signal capable of affecting another in some way.

## **Modulation Matrix**

Often shorted to Mod Matrix. The facility provided by synthesizers to allow flexible routing of modulation sources to modulation destinations. Originally, most syn-

thesizers had fixed modulation paths which limited possibilities. The Mod Matrix offer almost unlimited modulation possibilities (although not all of them are useful). In addition to a range of fixed modulators, Kyra offers six modulation matrix channels, each channel offering up to three destinations thus providing a total maximum of 18 routings.

## **Mono Play**

Restricting a Part to only play one note at a time. Useful for legato effects such as bass playing.

## **Multi**

A stored configuration of all 8 Parts. A Multi allows instant recall of the configuration of all 8 Parts - either from the front panel or via MIDI (using the Multi program change feature).

## **Multitimbral**

The ability of a synthesizer to play multiple sounds (specifically, multiple Patches) at the same time. Kyra is multitimbral as it has 8 completely independent Parts. The term 'polytimbral' is also used to mean the same thing.

## **Octave**

A musical interval corresponding to a doubling or halving of pitch.

## **OLED**

Organic Light Emitting Diode. A relatively new display technology that offers many improvements over traditional LCDs (Liquid Crystal Displays). Typical advantages include faster response times as well as dramatically improved contrast and viewing angles. Kyra features an OLED display.

## **Oscillator Group**

A grouping of oscillators within the sound source section of Kyra. Kyra supports two independent Oscillator Groups providing a total of ten sound sources per voice.

## **Outboard**

Signal processing units in the Kyra signal chain that are applied externally, i.e. beyond its own internal effects units.

## **Oversampling**

The technique of operating a digital audio system at a multiple of the fundamental sample rate (of 48kHz in the case of Kyra) to avoid aliasing. Kyra's oscillators operate at

32x the fundamental rate and use other techniques as well to all but eliminate aliasing. The filters and effects units are two times oversampled. The result is a system with a clean, bright top end that can support techniques particularly prone to aliasing such as hard sync, FM, ring modulation and wavetable playback. Systems that are not oversampled often suffer from aliasing and/or have muddy or noisy top end performance where they must use intrusive filtering to attempt to avoid aliasing or attempt to conceal it when it has already happened. When configured for 48kHz output there is a small possibility of aliasing on the USB audio streams.

## **Pan**

The location of a sound in the stereo field. 'Panning' implies changing the pan value so that the sound 'moves' within the stereo field.

## **Part**

The configuration of one of the 8 independent sub-modules of Kyra. It is reasonable to view a Part as a complete synthesizer. Each Part can play a configurable sound (as determined by the Patch loaded into it) and has its own set of configurable parameters.

## **Passband**

The range of filters passed (not attenuated) by a filter.

### **Patch**

The settings that determine the sound a Part will play when note requests are made via MIDI. Each Part hosts one Patch from the pool of Patches stored by the system. Kyra can store up to 3,328 Patches. Any Patch can be recalled instantly from the front panel or by means of a MIDI commands (Program Change and Bank Select).

### **Phaser**

An effect based on banks of modulated all-pass filters (as opposed to delay lines). Provides an airy effect somewhat like a flanger but subtler and more delicate in nature. Kyra has a six-stage Phaser available on each Part. Phasers are very useful for simulating vocal formants and adding other resonant tonalities to sounds.

### **Polyphonic Pressure**

Often shortened to Poly Pressure. A MIDI feature to allow modulation of notes by pressing down on individual keyboard keys. Very few keyboards support the generation of polyphonic pressure information but it is possible to add it in many DAWs. Kyra can receive poly pressure information; the data is fed into the Mod Matrix and can be used to modulate any polyphonic destination. Poly pressure can generate a lot of MIDI information so use it sparingly when using DIN MIDI.

### **Polyphony**

The maximum number of simultaneous notes supported by an instrument. Kyra supports 128 notes of single voice polyphony with up to 32 notes per Part.

### **Polytimbrality**

See Multitimbral.

### **Portamento**

A technique whereby notes glide from one to the next. Kyra implements real polyphonic portamento whereby the base pitch for a new note is the pitch of the last note played on the channel and all notes take the same, configurable time to reach their final pitch regardless of the size of the interval. In Mono key mode, Kyra implements monophonic portamento which only occurs for note played legato.

### **Pulse**

A basic waveform with a characteristic hollow, boxy sound. The timbre is very much dependent on the width of the pulses and modulation of the pulse width (PWM) provides a distinctive sound. Available as a basic waveform in both Oscillator Groups and their sub-oscillators.

## **PWM**

Pulse Width Modulation. The technique of modulating (varying) the width of a pulse wave to change its timbre. When modulated by an LFO, PWM provides a very pleasing, chorus-style sound.

## **Q**

Q or Q-Factor is a parameter of the mid band of Kyra's EQ module. Higher Q values will make the band more selective (for boost or cut). Lower Q values will make the band wider. Filter resonance is also referred to as 'Q'.

## **Quadrature LFO**

A special setting for a Kyra LFO such that the LFO's output is phase shifted 90 degrees before it is applied to the specified modulation target of the second voice of a Dual Mode note. Compare this to the 180-degree shift when antiphase mode is selected. The Phaser and Formant modules in the Effects Unit also have their own quadrature LFOs.

## **RAM**

Random Access Memory. In the context of Patch and Multi storage, RAM allows you to store Patches and Multis quickly. The RAM in Kyra is backed up with a rechargeable battery so that the contents of the RAM are maintained when the system is switched off (either in standby or completely

powered down). RAM is, however, limited in size and Kyra supports 7 Banks of Patch storage, each containing 128 Patches along with 128 locations for Multi storage. ROM storage can be used to extend the capacity, please see ROM.

## **Release**

The fourth and final of the segments in an ADSR-style envelope generator. The release segment starts when a key is released or the sustain pedal is lifted and ends when the level reaches zero. At that point, the note no longer exists and the voice can be re-allocated.

## **Resonance**

An attribute of a filter, typically an audio filter, whereby feedback is used to emphasise the frequencies around the cutoff point (and consequently, increase the roll-off rate of the cutoff itself). Resonance adds considerable character to a sound, especially when the cutoff frequency is modulated.

## **Retrigger**

If a note is played that is already playing (e.g. playing the same note twice in quick succession) the note is retriggered rather than another note at the same pitch being played more than once. In this context retriggering means the replacement note will play from the level the previous one



was at the time of the retrigger. In most cases this works smoothly but if the note velocity of the retriggering note is significantly different there may be a perceived jump in volume resulting in, depending on the sound itself, an unwanted click; skillful playing and/or careful editing in a DAW will avoid this if it is a problem.

### **Reverberation**

Often shortened to Reverb or just rev, an effect that simulates the acoustics of an enclosed space. Adds space and 'air' to sounds that would otherwise sound artificial, dry and flat.

### **Ring Modulator**

A sound processing effect which multiplies two waveforms together to produce a third. This results in the addition of a lot of extra harmonics and a very distinctive sound as the ratio of the frequency of the two source sounds is changed. Kyra implements a ring modulator between the two Oscillator Group wavetables.

### **Rolloff**

The rate at which a filter attenuates harmonics as they beyond the cutoff frequency. Kyra offers two pole filters with a relatively gentle 12dB/octave rolloff and four pole filters with a more aggressive 24dB/octave rolloff.

### **ROM**

Read Only Memory. In the context of Patch storage, ROM allows you to store several Patch banks which are stored indefinitely without the need for the battery that is used to maintain RAM. On the other hand, you can't store Patches individually in ROM and must use the Copy Patch Bank to write whole Banks of Patches to ROM. You can, however, recall Patches individually just as if they were in RAM. When combined with the RAM Patch storage, Kyra offers a generous 26 banks of storage which is a total of 3,328 Patches.

### **Rompler**

Short for 'Read only Memory Player' a type of synthesizer popular in the 90s and 00s that had a fixed set of sounds stored as sampled audio in memory with very little ability to edit or process them. Whilst being cheap to make and easy to use, these synthesizers usually had a limited ability to create new sounds.

### **RPN**

Registered Parameter Number. This is a set of MIDI- defined parameters. Kyra responds to RPN 0 for bend range, RPN 1 for fine tuning and RPN 2 for coarse tuning of a Part.

## Sample Rate

The frequency of the intervals used to represent sound in a digital audio system. Higher sample rates allow the representation of higher frequency sounds as well as allowing the system to be more tolerant of out of band signals that can cause aliasing. Kyra has a native sample rate of 32x (1536kHz) for all sound generation and 2x (96kHz) for filtering, effects and final audio output. The result of this is sounds that are virtually alias-free.

## Sawtooth

A harmonically-rich waveform that has a trumpet-like sound. An ideal source for subtractive synthesis owing to its rich harmonic content which includes odd and even harmonics. Available as a basic VA waveform in both Oscillator Groups and their Sub Oscillators. Technically, Kyra produces a ramp waveform but the harmonic content is identical.

## Screen Saver

A timer that reduces the contrast and eventually switches off the display in order to reduce the risk of image burn or shortened display lifetime. By leaving the screen saver on its default settings, there's less chance of damage to the OLED display if you forget to switch off your instrument as the screensaver will protect it. The instrument remains

fully functional even if the display has switched off. Manipulating any front panel control will restore the display. Disabling the screensaver is not recommended as leaving it on for very long periods may shorten its lifetime. Note that the screensaver will activate after 24 hours even if it is disabled.

## Semitone

A musical interval representing 100 cents or one twelfth of an octave. The interval between two keys on a keyboard.

## Sequencer

A computer program (or occasionally a standalone hardware device) that allows the recording, arrangement and replay of MIDI data. A sequencer with the ability to record and process digital audio is usually referred to as a DAW (Digital Audio Workstation).

## Signal to noise ratio

The 'distance' between the signal (the bit you want to hear, the music) and the 'noise' (the bit you don't want to hear).

As the noise level in many systems is largely fixed, higher (and hence better) signal to noise ratios are obtained by having the signal as loud ('hot') as possible. That is true on Kyra and you should ensure levels are as high as they can be without risking distortion. Excessively low signal levels

combined with high subsequent amplification will reduce the signal to noise ratio. In the unlikely situation you hear noise (hissing) from Kyra, check that volumes are at the right level. If you find the Master volume is much below 75% of its full level, look to turn that up and reduce the level of your monitor amplifiers. Finding the right levels is always a tradeoff and getting it right is a matter using your ears and experience.

### **Slope**

A setting in Kyra's envelope generators that allows the sustain portion of the envelope to take on a downward or upward bias. This effectively makes the sustain portion into another decay slope but with the additional feature of being able to increase as well as decay.

### **Software (or Firmware) Update**

The ability of Kyra to receive updated software versions via USB. Software Updates can contain new features and bug fixes.

### **Song Position Pointer**

A feature of MIDI used by DAWs to specify where a song is being played from. Kyra uses this information to start and synchronise its arpeggiator. Often shortened to 'SPP'.

### **Sostenuto**

A variation of note sustain whereby only notes played whilst the sostenuto pedal is down are sustained. Not as common as the sustain pedal but often used by classically trained pianists. Useful for holding block chords in lower registers whilst playing a melody in higher registers. Kyra supports MIDI sostenuto.

### **SSD**

Solid State Disk. A type of hard disk using Flash memory rather than magnetic disks. When recording multiple 96kHz 24-bit streams from Kyra, your DAW will perform better if it has an SSD.

### **Staccato**

Notes that are played such that the previous note is released before the next is played, the opposite of legato. In Mono key mode, Kyra will suspend portamento for notes played staccato.

### **Stopband**

The range of frequencies attenuated by a filter.

### **Sub Oscillator**

An oscillator that is tuned to a frequency below that of a main oscillator, typically one octave below. Used to provi-

de extra bass and body to a sound. Kyra features an independently tunable Sub Oscillator in each of its two Oscillator Groups. The hypersaw also has a sub oscillator feature.

### **Sustain**

The third of the four segments in an ADSR-style envelope generator. The sustain segment starts when the decay reaches the configured sustain level and ends when the key is released. The sustain pedal effectively holds the sustain period of a note until the sustain pedal is released, regardless of when the keys themselves are released.

### **Sustain Pedal**

Sometimes shortened to sus or hold pedal. A pedal (and corresponding MIDI command) to sustain notes regardless of the lifting of fingers from keys until the sustain pedal is released.

### **System Exclusive**

Often shortened to 'SysEx'. A part of the MIDI specification that allows proprietary (non-standard) information to be exchanged between MIDI devices. Kyra uses System Exclusive messages to allow the saving, configuration and restoring of Patch, Multi and System configuration data. Kyra also supports certain universal SysEx messages, these are detailed in the MIDI implementation chart.

### **Timbre**

The tonal quality of a sound.

### **Tremolo**

Amplitude (level) modulation by a periodic source, typically an LFO

### **TRS**

Tip, ring, sleeve. A type of audio cable that carries a single channel of balanced audio. On Kyra, two cables are required for stereo operation. Kyra's line outputs are balanced TRS-type jacks. Kyra will operate with non-balanced cables and mixers but you will lose the benefits of balanced audio (primarily, increased tolerance of interference and noise). This loss of quality will be more evident with longer cables.

### **UAC2**

USB Audio Class 2.0. A specification for USB that supports multichannel, low latency, high quality audio over USB. macOS supports UAC2 natively but Windows, as at Windows 10, requires a driver to be installed to handle UAC2.

## **Unison**

A feature of some synthesizers to sound two or more voices for each note possibly with a slight detuning between them. Kyra offers Dual Mode as an alternative to Unison. It sounds less mechanical and uses fewer resources than plain unison.

## **USB**

Universal Serial Bus. A serial computer bus able to communicate commands (like MIDI) and stream low-latency audio between systems. Various standards of USB are defined with increasing speeds and features available to later versions of the standard. Kyra requires support for at least USB 2.0 ('high speed') to use USB.

## **VCA**

Voltage Controlled Amplifier. The part of an analogue synthesizer that controls the level of the sound, usually under the control of a modulator such as an envelope generator. In digital instruments such as Kyra, the VCA is implemented digitally but the concept is identical so there's no reason not to use the existing terminology.

## **Virtual Analogue**

Often shortened to 'VA'. The process of using discrete time signal processing to emulate classic analogue synthesis.

## **Voice Stealing**

The algorithm used to decide how to deal with a request to play more notes (voices) than supported by a synthesizer. The algorithm used by Kyra within a Part is to steal (reassign) the oldest (longest-playing) note from a Part when a request to play a 33rd note arrives (each Part can support up to 32 notes, subject to a system total of 128). There is no voice stealing between Parts and if the overall limit of 128 is exceeded, further note play requests are ignored.

## **Wavetable**

A type of synthesis where fragments (single cycle) waveforms are played back as a loop. Kyra offers two wavetables on each note (there's one in each Oscillator Group). The wavetables are a large portion of the sonic palette of Kyra as there's an unusually large number of them available (4096) covering a very large range of sounds, especially when combined with hard sync and the traditional virtual analogue waveforms available in each Oscillator Group. Often shortened to just 'wave'.

## **Wet**

The component of a signal that has been processed by an effect. The component of a signal that has not been processed by an effect is referred to as the 'dry' signal.

# Product Support

## Service & Repair

Kyra does not contain any user-serviceable parts. If your Kyra develops a fault or needs servicing, please refer to a Waldorf authorised service center. For more information, please ask your musicians dealer or your local Waldorf distributor.

## Any Questions?

If you have any questions about your Waldorf product, feel free to contact us using one of the three options listed below. We're here to help.

① Use the support form at our website. This is the most efficient and fastest way to contact us. Your questions will be forwarded immediately to the resident expert and you will quickly receive an answer.

<https://support.waldorfmusic.com>

② Send us a letter. It will take a bit longer, but it is just as dependable as the support form.

**Waldorf Music GmbH**  
**Lilienthalstr. 7**  
**53424 Remagen, Germany**

③ Visit our support forum at [www.waldorfmusic.com](http://www.waldorfmusic.com)

# MIDI Implementation Chart

	Transmit/ Export	Recognize/ Import	Remarks
MIDI channels	16	16	Via USB or MIDI
Note numbers	1-127	1-127	
Program change	-	0-127	
Bank Select response? (Yes/No) If yes, list banks utilized in remarks column		Yes	0-25
Modes supported: Mode 1: Omni-On, Poly (Yes/No) Mode 2: Omni-On, Mono (Yes/No) Mode 3: Omni-Off, Poly (Yes/No) Mode 4: Omni-Off, Mono (Yes/No) Multi Mode (Yes/No)		No	Always Omni-Off, Poly
Note-On Velocity (Yes/No)	Yes	Yes	Arpeggiator can transmit note events
Note-Off Velocity (Yes/No)	No	Yes	
Channel Aftertouch (Yes/No)	No	Yes	
Poly (Key) Aftertouch (Yes/No)	No	Yes	
Pitch Bend (Yes/No)	No	Yes	
Active Sensing (Yes/No)	No	Yes	
System Reset (Yes/No)	No	No	
Tune Request (Yes/No)	No	No	

## MIDI Implementation Chart

Universal System Exclusive: Sample Dump Standard (Yes/No)	No	No	Setting is persistent
Device Inquiry (Yes/No)	No	Yes	
File Dump (Yes/No)	No	No	
MIDI Tuning (Yes/No)	No	No	
Master Volume (Yes/No)	No	Yes	
Master Balance (Yes/No)	No	No	
Notation Information (Yes/No)	No	No	
Turn GM1 System On (Yes/No)	No	No	
Turn GM2 System On (Yes/No)	No	No	
Turn GM System Off (Yes/No)	No	No	
DLS-1 (Yes/No)	No	No	
File Reference (Yes/No)	No	No	
Controller Destination (Yes/No)	No	No	
Key-based Instrument Ctrl (Yes/No)	No	No	
Master Fine/Coarse Tune (Yes/No)	No	Yes	
Other Universal System Exclusive	No	No	
Manufacturer or Non-Commercial System Exclusive	Yes	Yes	
NRPNS (Yes/No)	No	No	
RPN 00 (Pitch Bend Sensitivity) (Yes/No)	No	Yes	1-12 semitones
RPN 01 (Channel Fine Tune) (Yes/No)	No	Yes	Plus or minus one semitone, 64 is base
RPN 02 (Channel Coarse Tune) (Yes/No)	No	Yes	Two octaves either way, 64 is base



## MIDI Implementation Chart

---

RPN 03 (Tuning Program Select) (Yes/No)	No	No	
RPN 04 (Tuning Bank Select) (Yes/No)	No	No	
RPN 05 (Modulation Depth Range) (Yes/No)	No	No	
MIDI Clock (Yes/No)	Yes	Yes	
Song Position Pointer (Yes/No)	No	Yes	
Song Select (Yes/No)	No	No	
Start (Yes/No)	No	Yes	
Continue (Yes/No)	No	Yes	
Stop (Yes/No)	No	Yes	
MIDI Time Code (Yes/No)	No	No	
MIDI Machine Control (Yes/No)	No	No	
MIDI Show Control (Yes/No)			
If yes, MSC Level supported	No	No	
General MIDI compatible? (Level(s)/No)	No	No	
Is GM default power-up mode? (Level/No)			
DLS compatible? (Levels(s)/No)	No	No	
(DLS File Type(s)/No)			
Standard MIDI Files (Type(s)/No)	No	No	
XMF Files (Type(s)/No)	No	No	
SP-MIDI compatible? (Yes/No)	No	No	

## MIDI Implementation Chart

---

Control	Function	Transmitted (Y/N)	Recognized (Y/N)	Remarks
0	Bank Select (MSB)	No	No	
1	Modulation Wheel (MSB)	No	Yes	
2	Breath Controller (MSB)	No	Yes	
3		No	Yes	
4	Foot Controller (MSB)	No	Yes	
5	Portamento Time (MSB)	No	Yes	
6	Data Entry (MSB)	No	Yes	
7	Channel Volume (MSB)	No	Yes	Configures Part level
8	Balance (MSB)	No	Yes	
9		No	Yes	
10	Pan (MSB)	No	Yes	Configures Part Pan
11	Expression (MSB)	No	Yes	
12	Effect Control 1 (MSB)	No	Yes	
13	Effect Control 2 (MSB)	No	Yes	
14		No	Yes	
15		No	Yes	
16	General Purpose Controller 1 (MSB)	No	Yes	
17	General Purpose Controller 2 (MSB)	No	Yes	
18	General Purpose Controller 3 (MSB)	No	Yes	
19	General Purpose Controller 4 (MSB)	No	Yes	
20		No	Yes	

## MIDI Implementation Chart

---

Control	Function	Transmitted (Y/N)	Recognized (Y/N)	Remarks
21		No	No	
22		No	No	
23		No	No	
24		No	No	
25		No	No	
26		No	No	
27		No	No	
28		No	No	
29		No	No	
30		No	No	
31		No	No	
32	Bank Select (LSB)	No	Yes	
33	Modulation Wheel (LSB)	No	No	
34	Breath Controller (LSB)	No	No	
35		No	No	
36	Foot Controller (LSB)	No	No	
37	Portamento Time (LSB)	No	No	
38	Data Entry (LSB)	No	No	
39	Channel Volume (LSB)	No	No	
40	Balance (LSB)	No	No	
41		No	No	

MIDI Implementation Chart

---

Control	Function	Transmitted (Y/N)	Recognized (Y/N)	Remarks
42	Pan (LSB)	No	No	
43	Expression (LSB)	No	No	
44	Effect Control 1 (LSB)	No	No	
45	Effect Control 2 (LSB)	No	No	
46		No	No	
47		No	No	
48	General Purpose Controller 1 (LSB)	No	No	
49	General Purpose Controller 2 (LSB)	No	No	
50	General Purpose Controller 3 (LSB)	No	No	
51	General Purpose Controller 4 (LSB)	No	No	
52		No	No	
53		No	No	
54		No	No	
55		No	No	
56		No	No	
57		No	No	
58		No	No	
59		No	No	
60		No	No	
61		No	No	
62		No	No	

## MIDI Implementation Chart

---

Control	Function	Transmitted (Y/N)	Recognized (Y/N)	Remarks
63		No	No	
64	Sustain Pedal	No	Yes	
65	Portamento On/Off	No	Yes	
66	Sostenuto	No	Yes	
67	Soft Pedal	No	Yes	
68	Legato Footswitch	No	No	
69	Hold 2	No	No	
70	Sound Controller 1 (default: Sound Variation)	No	No	
71	Sound Ctrl 2 (default: Timbre/Harmonic Quality)	No	No	
72	Sound Controller 3 (default: Release Time)	No	No	
73	Sound Controller 4 (default: Attack Time)	No	No	
74	Sound Controller 5 (default: Brightness)	No	Yes	Maps to Filter 1 Cutoff Frequency
75	Sound Controller 6 (GM2 default: Decay Time)	No	No	
76	Sound Controller 7 (GM2 default: Vibrato Rate)	No	No	
77	Sound Controller 8 (GM2 default: Vibrato Depth)	No	No	
78	Sound Controller 9 (GM2 default: Vibrato Delay)	No	No	
79	Sound Controller 10 (GM2 default: Undefined)	No	No	
80	General Purpose Controller 5	No	No	
81	General Purpose Controller 6	No	No	
82	General Purpose Controller 7	No	No	
83	General Purpose Controller 8	No	No	

## MIDI Implementation Chart

---

Control	Function	Transmitted (Y/N)	Recognized (Y/N)	Remarks
84	Portamento Control	No	No	
85	(custom) Filter 1 Cutoff Frequency	No	Yes	
86	(custom) Filter 2 Cutoff Frequency	No	Yes	
87	(custom) Filter 1 Resonance	No	Yes	
88	(custom) Filter 2 Resonance	No	Yes	
89		No	No	
90		No	No	
91	Effects 1 Depth (default: Reverb Send)	No	No	
92	Effects 2 Depth (default: Tremolo Depth)	No	No	
93	Effects 3 Depth (default: Chorus Send)	No	No	
94	Effects 4 Depth (default: Celeste [Detune] Depth)	No	No	
95	Effects 5 Depth (default: Phaser Depth)	No	No	
96	Data Increment	No	No	
97	Data Decrement	No	No	
98	Non-Registered Parameter Number (LSB)	No	No	
99	Non-Registered Parameter Number(MSB)	No	No	
100	Registered Parameter Number (LSB)	No	No	
101	Registered Parameter Number(MSB)	No	No	
102		No	No	
103		No	No	
104		No	No	

## MIDI Implementation Chart

---

Control	Function	Transmitted (Y/N)	Recognized (Y/N)	Remarks
105		No	No	
106		No	No	
107		No	No	
108		No	No	
109		No	No	
110		No	No	
111		No	No	
112		No	No	
113		No	No	
114		No	No	
115		No	No	
116		No	No	
117		No	No	
118		No	No	
119		No	No	
120	All Sound Off	No	Yes	
121	Reset All Controllers	No	Yes	
122	Local Control On/Off	No	No	
123	All Notes Off	No	Yes	
124	Omni Mode Off	No	No	
125	Omni Mode On	No	No	

## MIDI Implementation Chart

---

<b>Control</b>	<b>Function</b>	<b>Transmitted (Y/N)</b>	<b>Recognized (Y/N)</b>	<b>Remarks</b>
126	Poly Mode Off	No	No	
127	Poly Mode On	No	No	



Waldorf Music GmbH • Lilienthal Straße 7 • D-53424 Remagen  
© 2011 Waldorf Music GmbH • All rights reserved  
[www.waldorfmusic.com](http://www.waldorfmusic.com)

