

WWW.MUSICAREA.CN

WESTERN
INSTRUMENT

CASES

P R O D U C T

现代西方乐器包

C A T A L O G



MUSIC AREA
CASES

TABLE OF CONTENTS

产品目录

吉他、贝斯包

AA31	1-6
AA30	7-10
龙	11-16
汉30	19-26
风30	29-36
唐30	39-48
精英30	51-56
风20	59-66
精英20	69-72
精英10	73-76

打击乐包

军鼓包	77-78
镲片包	81-82
鼓棒包	83-84

键盘包

61键键盘包	85-88
76键键盘包	85-88
88键键盘包	85-88

尤克里里包

89-92

萨克斯包

93-94

提琴包

95-96

其他

木箱背负系统	42
恒温双肩背包	97
吉他背带	98

GUITAR & BASS CASES

AA31
AA30
DRAGON
HAN30
WIND30
TANG30
RB30
WIND20
RB20
RB10

PERCUSSION CASES

SNARE CASES
CYMBAL CASES
DRUM STICK CASES

KEYBOARD CASES

61-KEY KEYBOARD CASES
76-KEY KEYBOARD CASES
88-KEY KEYBOARD CASES

UKULELE CASES

SAXOPHONE CASES

VIOLIN CASES

OTHER PRODUCTS

HARD-CASE BACKPACK
ISOTHERMIC BACKPACK
GUITAR STRAPS



GUITAR & BASS CASES

吉他 & 贝斯包



OTHER CASES

其他乐器包



键盘包

萨克斯包

尤克里里包

提琴包

镲片包

军鼓包

恒温双肩背包

鼓棒包

PREMIUM
PROTECTION
FOR
PRECIOUS
PROPERTY



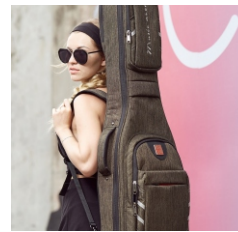

ARTISTS & FRIENDS



Ruby Industrial Co., Ltd is a leading manufacturer that designs and makes premier bags and cases for musical instruments.

东莞市乐邦实业有限公司是一家全球领先的专业乐器箱包制造商。

Over the past 10 years, we have been providing ODM and OEM services for numerous brands like YAMAHA, F BASS, etc.

过去10年来，我们一直持续为世界众多知名乐器品牌提供ODM和OEM服务，如YAMAHA, F BASS等。

Products

Gig bags and cases for fretted, brass, woodwind, strings and percussion instruments.

产品范围

有品弦乐器，无品弦乐器，管乐器和打击乐器等主流中西乐器的箱包。

Excellent Protection

Shock-proof, Drop-proof, Water-proof, Moisture-proof, Mildew-proof, Sun-proof, Scratch-proof.

卓越保护

防震，防摔，防水，防潮，防霉，防晒，防刮。

All fabrics are customized by our unique formula and have RoHS & REACH Certificate of Compliance which meets EU environmental policy.

选材严格

所有布料均选用自己的纺织配方独特定制，所有材料都符合欧盟ROHS, REACH等环保标准。



Skilled workers are the key factors that make us an unshakable leader position in the industry. Including sewing workers, materials researchers, mold engineers, and even warehouse managers, they have been working in Ruby for more than 15 years, which is a solid foundation for our long-term cooperation with YAMAHA and other world-class brands.

使我们在行业中处于不可动摇的领先地位的核心资产是我们的员工，包括车缝人员，材料研究员，模具工程师，甚至仓库管理人员，他们都在乐邦工作了15年以上，这是我们与YAMAHA及其他世界级品牌建立长期合作的坚实基础。

2012

In 2012, we established our own brand: Music Area — aiming to build a high-end instrument cases production base. Our logo is designed as an Imperial Seal of China to present the profound culture in China and deliver our brand concept: A guarantee of Superior Quality Products.

2012年，我们建立了自己的品牌：音乐驿站 — 以打造高端乐器箱包生产基地为目的，以广交天下音乐朋友为营销理念，以中文为品牌商标，为天下琴友提供卓越和专业的乐器箱包。

In 2015, we started promotion of Music Area after three years' research and development, and we have finalized multiple series of instrument gig cases, such as AA31, WIND30, HAN30 and TANG30. In less than two years, our cases become favored by many famous artists including Chuck Rainey, Neil Zaza, Silas Fernandes, Don Alder, Travis Bowman and so forth.

2015年，经过三年的研发，我们发布了AA31，WIND30，HAN30，TANG30等多个系列的乐器包，并全面地展开了音乐驿站的推广工作。

在不到两年的时间里，我们的琴包受到了众多著名艺术家的青睐，其中包括国内的：冯满天及中央民族乐团、零点乐队、黑豹乐队、夜叉乐队、左右乐队、丢火车乐队、玩具船长、李志、李健、崔健、韩虹、赵雷、曹思义、兰海鹏等；国外的：Chuck Rainey, Neil Zaza, Silas Fernandes, Don Alder, Travis Bowman等等。

2015



MUSIC AREA
C A S E S

Become an innovative designer and solution provider for instrument cases
Devote ourselves to offering customers quality products and services
Make better instrument bags and cases providing superior safety.
Create a Chinese brand that makes Chinese proud.
Show the world the difference of "Made in China".

成为乐器箱包的创新设计商和解决方案供应商
致力于为客户提供优质的产品和服务
制造更好的更安全的乐器箱包
打造一个让中国人自豪的中文品牌
让全世界重新认识“中国制造”



AA31-EG-BLK

AA31 (BLACK)

AA31 (黑色)



ELECTRIC GUITAR CASE
电吉他包

AA31-EG-BLK



BASS GUITAR CASE
贝斯包

AA31-EB-BLK



WHEELS
带脚轮

DUAL E-GUITAR CASE
双电吉他包

AA31-2EG-BLK



WHEELS
带脚轮

DUAL E-BASS CASE
双电贝斯包

AA31-2EB-BLK

MAX DIMENSION OF SUITABLE GUITARS



LENGTH
总长
1029 mm
40.5 in.



DEPTH
深度
64 mm
2.5 in.



LENGTH
总长
1237 mm
48.7 in.



DEPTH
深度
64 mm
2.5 in.



LENGTH
总长
1029 mm
40.5 in.



DEPTH
深度
127 mm
5 in.

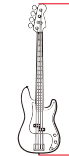

LENGTH
总长
1237 mm
48.7 in.



DEPTH
深度
127 mm
5 in.

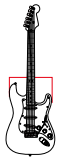

UPPER
BOUT
WIDTH
上桶宽
279 mm
11 in.



LOWER
BOUT
WIDTH
下桶宽
356 mm
14 in.

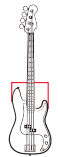

UPPER
BOUT
WIDTH
上桶宽
305 mm
12 in.



LOWER
BOUT
WIDTH
下桶宽
381 mm
15 in.

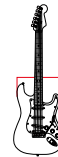

UPPER
BOUT
WIDTH
上桶宽
279 mm
11 in.



LOWER
BOUT
WIDTH
下桶宽
356 mm
14 in.

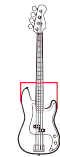

UPPER
BOUT
WIDTH
上桶宽
305 mm
12 in.



LOWER
BOUT
WIDTH
下桶宽
381 mm
15 in.

NET WEIGHT / 净重
4.1 KG / 9.04 LBS

NET WEIGHT / 净重
4.3 KG / 9.48 LBS

NET WEIGHT / 净重
5.5 KG / 12.13 LBS

NET WEIGHT / 净重
6.3 KG / 13.9 LBS

MULTI-ANGLE VIEW 多角度视图



PRODUCT HIGHLIGHTS 产品亮点



STRAP PIN PROTECTION

The 40mm thick pad protects the strap pin from shock-damage and it's removable or relocated for different size of body size.

尾钉保护垫

琴包底部约40毫米厚的加强缓冲垫有效防止背带尾钉和琴体在跌落时受到损坏，它也是可以拆卸或放在侧面使用，让琴包可以适用于不同体积的琴体。



HIDEABLE STRAPS

Shoulder straps can be hidden in a pocket to prevent you being stumbled by stepping on them when you carry by the side handle.

肩带收纳袋

琴包背面配有肩带收纳袋，在您不需要使用背带时，可将背带放进收纳袋以防止背带弄脏，同时还能避免您在使用侧面提手时误踩到背带而导致滑倒的隐患。



PADDED NECK CRADLE

The padded neck cradle is firmly in place and the headstock is fully protected against backward drops and side-to-side impacts.

琴颈保护枕

琴包内部配有一个厚实而且软硬适中的琴颈支撑垫，用于保护琴颈和琴头不受晃动或跌落带来的风险，而且它是可以根据不同琴颈的尺寸自由调节最佳的支撑位置。

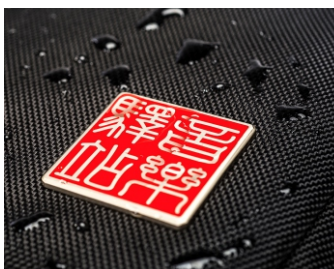

WATER-PROOF MATERIAL

The waterproof coating on the surface and PVC coating on the opposite side effectively prevents the liquid from infiltrating into the case.

防水材料

琴包表面材料加入了防水涂层，面料的反面加有PVC涂层，可以有效防止液体渗入包中。



ROOM FOR TWO

AA31-2EG-BLK is especially designed for carrying two electric guitars and AA31-2EB-BLK is for two basses. There's a thick pad that safely separates the two instruments.

双琴包

AA31-2EG-BLK可以容纳两把电吉他，AA31-2EB-BLK可以容纳两把电贝司，他们内部都设有一块厚厚的垫子将两把琴独立并安全地保存起来。



FOOTHOLDS AND WHEELS

Two footholds at the bottom to hold the case. Two wheels at the bottom for you to drag the case.

脚垫和脚轮

双琴包底部装有脚垫可以将琴包立起来，另外配有两个脚轮方便您拖动琴包。



30MM PADDING
30MM填充厚度



WATER-PROOF
防泼水

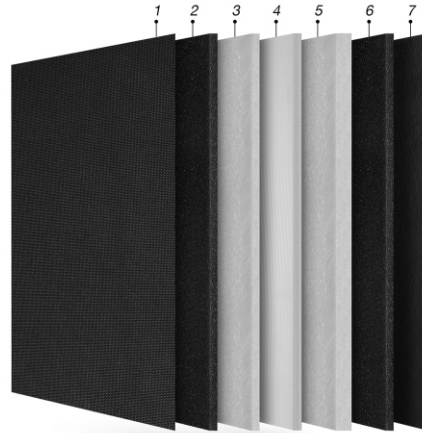

TOP & BACK
(from outer to inner layer)

1. 1680D Polyester
2. Polyurethane Foam (5mm)
3. EPE (5mm)
4. PP Reinforcing Plate (4mm)
5. EPE (10mm)
6. Polyurethane Foam (5mm)
7. Polyester Velboa Fabric

正面和背面
(从表层到里层)

1. 聚酯纤维
2. PU软泡棉 (5mm)
3. 聚乙烯发泡棉 (5mm)
4. PP加强板 (4mm)
5. 聚乙烯发泡棉 (10mm)
6. PU软泡棉 (5mm)
7. 毛绒布

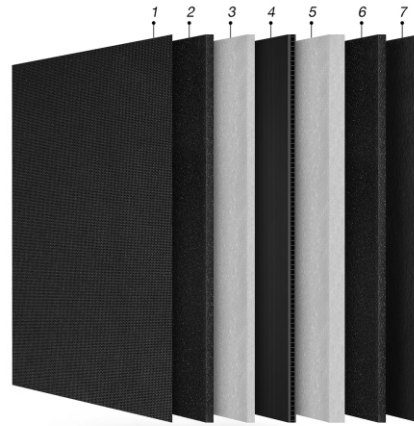

SIDES
(from outer to inner layer)

1. 1680D Polyester
2. Polyurethane Foam (5mm)
3. EPE (5mm)
4. ABS Reinforcing Plate (5mm)
5. EPE (10mm)
6. Polyurethane Foam (5mm)
7. Polyester Velboa Fabric

侧面
(从表层到里层)

1. 聚酯纤维
2. PU软泡棉 (5mm)
3. 聚乙烯发泡棉 (5mm)
4. ABS加强板 (5mm)
5. 聚乙烯发泡棉 (10mm)
6. PU软泡棉 (5mm)
7. 毛绒布



AA31-2EG-BLK



AA30-DA-BLK

AA30 (BLACK)

AA30 (黑色)



CLASSIC GUITAR CASE
古典吉他包

AA30-CG-BLK



ACOUSTIC GUITAR CASE
民谣吉他包

AA30-DA-BLK

MAX DIMENSION OF SUITABLE GUITARS



LENGTH
总长
1041 mm
41 in.



DEPTH
深度
127 mm
5 in.



LENGTH
总长
1054 mm
41.5 in.



DEPTH
深度
127 mm
5 in.

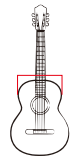

UPPER
BOUT
WIDTH
上桶宽
279 mm
11 in.



LOWER
BOUT
WIDTH
下桶宽
368 mm
14.5 in.

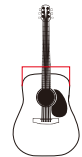

UPPER
BOUT
WIDTH
上桶宽
305 mm
12 in.



LOWER
BOUT
WIDTH
下桶宽
394 mm
15.5 in.

NET WEIGHT / 净重
4.42 KG / 9.7 LBS

NET WEIGHT / 净重
4.82 KG / 10.6 LBS

MULTI-ANGLE VIEW 多角度视图



PRODUCT HIGHLIGHTS 产品亮点



STRAP PIN PROTECTION

The 40mm thick pad protects the strap pin from shock-damage and it's removable or relocated for different size of body size.

尾钉保护垫

琴包底部约40毫米厚的加强缓冲垫有效防止背带尾钉和琴体在跌落时受到损坏，它也是可以拆卸或放在侧面使用，让琴包可以适用于不同体积的琴体。

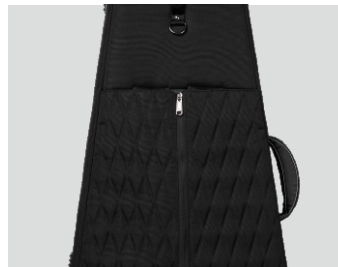

HIDEABLE STRAPS

Shoulder straps can be hidden in a pocket to prevent you being stumbled by stepping on them when you carry by the side handle.

肩带收纳袋

琴包背面配有肩带收纳袋，在您不需要使用背带时，可将背带放进收纳袋以防止背带弄脏，同时还能避免您在使用侧面提手时误踩到背带而导致滑倒的隐患。



PADDED NECK CRADLE

The padded neck cradle is firmly in place and the headstock is fully protected against backward drops and side-to-side impacts.

琴颈保护枕

琴包内部配有一个厚实而且软硬适中的琴颈支撑垫，用于保护琴颈和琴头不受晃动或跌落带来的风险，而且它是可以根据不同琴颈的尺寸自由调节最佳的支撑位置。



SHOULDER STRAPS

S-shaped shoulder straps with massage cushions are ergonomically designed to reduce the burden on the shoulders.

双肩背带

带按摩垫的S形双肩背带符合人体工程学设计，可减轻肩部负担。



30MM PADDING
30MM填充厚度



WATER-PROOF
防泼水



TOP & BACK
(from outer to inner layer)

1. 900D*400D Polyester
2. Polyurethane Foam (5mm)
3. EPE (5mm)
4. PP Reinforcing Plate (4mm)
5. EPE (10mm)
6. Polyurethane Foam (5mm)
7. Plush

正面和背面
(从表层到里层)

1. 聚酯纤维
2. PU软泡棉 (5mm)
3. 聚乙烯发泡棉 (5mm)
4. PP加强板 (4mm)
5. 聚乙烯发泡棉 (10mm)
6. PU软泡棉 (5mm)
7. 金丝绒



SIDES
(from outer to inner layer)

1. 900D*400D Polyester
2. Polyurethane Foam (5mm)
3. EPE (5mm)
4. ABS Reinforcing Plate (5mm)
5. EPE (10mm)
6. Polyurethane Foam (5mm)
7. Plush

侧面
(从表层到里层)

1. 聚酯纤维
2. PU软泡棉 (5mm)
3. 聚乙烯发泡棉 (5mm)
4. ABS加强板 (5mm)
5. 聚乙烯发泡棉 (10mm)
6. 软泡棉PU (5mm)
7. 金丝绒



DRAGON-EG

DRAGON

龙



ACOUSTIC GUITAR CASE
民谣吉他包
DRAGON-DA













ELECTRIC GUITAR CASE
电吉他包
DRAGON-EG

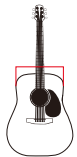

BASS GUITAR CASE
贝斯包
DRAGON-EB

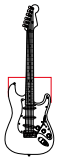
MAX DIMENSION OF SUITABLE GUITARS

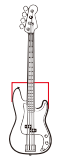
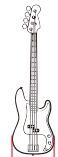
ACOUSTIC GUITAR CASE (DRAGON-DA)		ELECTRIC GUITAR CASE (DRAGON-EG)		BASS GUITAR CASE (DRAGON-EB)	
	LENGTH 总长 1080 mm 42.5 in.		DEPTH 深度 127 mm 5 in.		LENGTH 总长 1016 mm 40 in.
	DEPTH 深度 64 mm 2.5 in.		LENGTH 总长 1194 mm 47 in.		DEPTH 深度 64 mm 2.5 in.
	UPPER BOUT WIDTH 上桶宽 310 mm 12.2 in.		LOWER BOUT WIDTH 下桶宽 400 mm 15.7 in.		UPPER BOUT WIDTH 上桶宽 280 mm 11 in.
	LOWER BOUT WIDTH 下桶宽 381 mm 15 in.		UPPER BOUT WIDTH 上桶宽 343 mm 13.5 in.		LOWER BOUT WIDTH 下桶宽 394 mm 15.5 in.
NET WEIGHT / 净重 4.25 KG / 9.37 LBS		NET WEIGHT / 净重 4 KG / 8.8 LBS		NET WEIGHT / 净重 4.2 KG / 9.26 LBS	

MULTI-ANGLE VIEW 多角度视图



PRODUCT HIGHLIGHTS 产品亮点



STRAP PIN PROTECTION

The 40mm thick pad protects the strap pin from shock-damage and it's removable or relocated for different size of body size.

尾钉保护垫

琴包底部约40毫米厚的加强缓冲垫有效防止背带尾钉和琴体在跌落时受到损坏，它也是可以拆卸或放在侧面使用，让琴包可以适用于不同体积的琴体。



HIDEABLE STRAPS

Shoulder straps can be hidden in a pocket to prevent you being stumbled by stepping on them when you carry by the side handle.

肩带收纳袋

琴包背面配有肩带收纳袋，在您不需要使用背带时，可将背带放进收纳袋以防止背带弄脏，同时还能避免您在使用侧面提手时误踩到背带而导致滑倒的隐患。



PADDED NECK CRADLE

Two padded neck cradles are firmly in place so the headstock is fully protected against backward drops and side-to-side impacts.

琴颈保护枕

琴包内部配有两个厚实的琴颈支撑垫，用于保护琴颈和琴头不受晃动或跌落带来的风险，其中一个是可以根据不同琴颈的尺寸调节最佳的支撑位置。



FRONT HANDLE

The front handle allows you to use it uprightly in line to avoid inconveniencing other people by lifting the case with the side-handle.

正面提手

琴包正面设有提手，方便您在人群中或排队时使用，以避免在使用侧面提手时琴包过长而影响到他人。



RAIN COVER

Dragon series is not waterproof, but don't worry, a rain cover is added in the bottom pocket of the back case.

防雨罩

龙系列的面料不防水，但不用担心，琴包背面的底部口袋中配有防雨罩。



30MM PADDING
30MM填充厚度

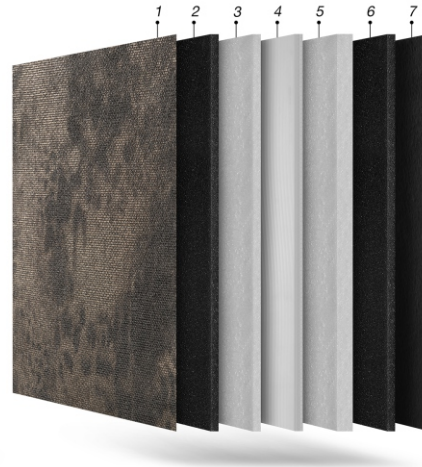

TOP & BACK
(from outer to inner layer)

1. Gilt Canvas
2. Polyurethane Foam (3mm)
3. EPE (5mm)
4. PP Reinforcing Plate (4mm)
5. EPE (10mm)
6. Polyurethane Foam (5mm)
7. Polyester Velboa Fabric

正面和背面
(从表层到里层)

1. 烫金帆布
2. PU软泡棉 (3mm)
3. 聚乙烯发泡棉 (5mm)
4. PP加强板 (4mm)
5. 聚乙烯发泡棉 (10mm)
6. PU软泡棉 (5mm)
7. 毛绒布



SIDES
(from outer to inner layer)

1. Gilt Canvas
2. Polyurethane Foam (3mm)
3. EVA (5mm)
4. EPE (15mm)
5. Polyurethane Foam (5mm)
6. Polyester Velboa Fabric

侧面
(从表层到里层)

1. 烫金帆布
2. PU软泡棉 (3mm)
3. EVA (5mm)
4. 聚乙烯发泡棉 (15mm)
5. PU软泡棉 (5mm)
6. 毛绒布



DRAGON-EG



DRAGON-EG



WIND30-EG-GRN



DRAGON-EG



HAN30-EG-BN

HAN30 (BROWN)

汉30 (棕色)



CLASSIC GUITAR CASE
古典吉他包

HAN30-CG-BN



ACOUSTIC GUITAR CASE
民谣吉他包

HAN30-DA-BN



ELECTRIC GUITAR CASE
电吉他包

HAN30-EG-BN



BASS GUITAR CASE
贝斯包

HAN30-EB-BN

MAX DIMENSION OF SUITABLE GUITARS



LENGTH
总长
1016 mm
40 in.



DEPTH
深度
127 mm
5 in.

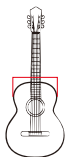

UPPER
BOUT
WIDTH
上桶宽
279 mm
11 in.



LOWER
BOUT
WIDTH
下桶宽
381 mm
15 in.

NET WEIGHT / 净重
4.56 KG / 10 LBS



LENGTH
总长
1054 mm
41.5 in.



DEPTH
深度
140 mm
5.5 in.

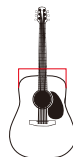

UPPER
BOUT
WIDTH
上桶宽
305 mm
12 in.



LOWER
BOUT
WIDTH
下桶宽
394 mm
15.5 in.

NET WEIGHT / 净重
4.66 KG / 10.3 LBS



LENGTH
总长
991 mm
39 in.



DEPTH
深度
64 mm
2.5 in.

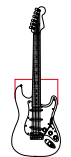

UPPER
BOUT
WIDTH
上桶宽
305 mm
12 in.



LOWER
BOUT
WIDTH
下桶宽
356 mm
14 in.

NET WEIGHT / 净重
3.9 KG / 8.6 LBS



LENGTH
总长
1199 mm
47.2 in.



DEPTH
深度
64 mm
2.5 in.

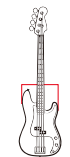

UPPER
BOUT
WIDTH
上桶宽
279 mm
11 in.

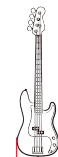

LOWER
BOUT
WIDTH
下桶宽
343 mm
13.5 in.

NET WEIGHT / 净重
4.33 KG / 9.55 LBS

MULTI-ANGLE VIEW 多角度视图



PRODUCT HIGHLIGHTS 产品亮点



STRAP PIN PROTECTION

The 40mm thick pad protects the strap pin from shock-damage and it's removable or relocated for different size of body size.

尾钉保护垫

琴包底部约40毫米厚的加强缓冲垫有效防止背带尾钉和琴体在跌落时受到损坏，它也是可以拆卸或放在侧面使用，让琴包可以适用于不同体积的琴体。



HIDEABLE STRAPS

Shoulder straps can be hidden in a pocket to prevent you being stumbled by stepping on them when you carry by the side handle.

肩带收纳袋

琴包背面配有肩带收纳袋，在您不需要使用背带时，可将背带放进收纳袋以防止背带弄脏，同时还能避免您在使用侧面提手时误踩到背带而导致滑倒的隐患。



PADDED NECK CRADLE

The padded neck cradle is firmly in place and the headstock is fully protected against backward drops and side-to-side impacts.

琴颈保护枕

琴包内部配有一个厚实而且软硬适中的琴颈支撑垫，用于保护琴颈和琴头不受晃动或跌落带来的风险，而且它是可以根据不同琴颈的尺寸自由调节最佳的支撑位置。

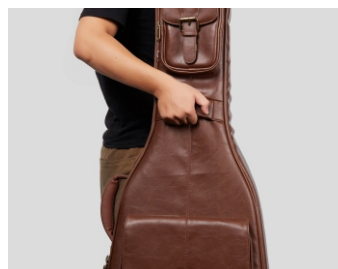

FRONT HANDLE

The front handle allows you to use it uprightly in line to avoid inconveniencing other people by lifting the case with the side-handle.

正面提手

琴包正面设有提手，方便您在人群中或排队时使用，以避免在使用侧面提手时琴包过长而影响到他人。



30MM PADDING
30MM填充厚度



WATER-PROOF
防泼水

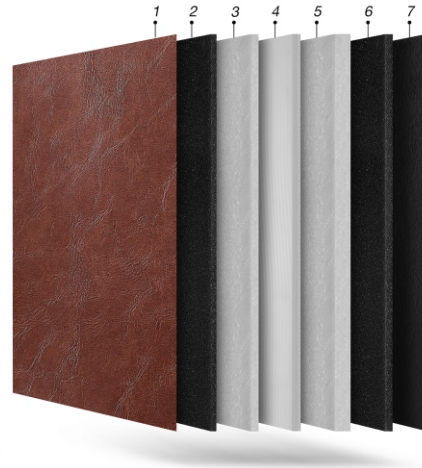

TOP & BACK
(from outer to inner layer)

1. PVC Leather
2. Polyurethane Foam (3mm)
3. EPE (5mm)
4. PP Board (4mm)
5. EPE (10mm)
6. Polyurethane Foam (5mm)
7. Polyester Velboa Fabric

正面和背面
(从表层到里层)

1. PVC皮革
2. PU软泡棉 (3mm)
3. 聚乙烯发泡棉 (5mm)
4. PP加强板 (4mm)
5. 聚乙烯发泡棉 (10mm)
6. PU软泡棉 (5mm)
7. 毛绒布



SIDES
(from outer to inner layer)

1. PVC Leather
2. Polyurethane Foam (3mm)
3. EPE (20mm)
4. Polyurethane Foam (5mm)
5. Polyester Velboa Fabric

侧面
(从表层到里层)

1. PVC皮革
2. PU软泡棉 (3mm)
3. 聚乙烯发泡棉 (20mm)
4. PU软泡棉 (5mm)
5. 毛绒布



HAN30-EG-GRY

HAN30 (GREY)

汉30 (灰色)



CLASSIC GUITAR CASE
古典吉他包

HAN30-CG-GRY



ACOUSTIC GUITAR CASE
民谣吉他包

HAN30-DA-GRY



ELECTRIC GUITAR CASE
电吉他包

HAN30-EG-GRY



BASS GUITAR CASE
贝斯包

HAN30-EB-GRY

MAX DIMENSION OF SUITABLE GUITARS



LENGTH
总长
1016 mm
40 in.



DEPTH
深度
127 mm
5 in.

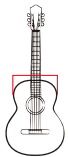

UPPER
BOUT
WIDTH
上桶宽
279 mm
11 in.



LOWER
BOUT
WIDTH
下桶宽
381 mm
15 in.

NET WEIGHT / 净重
4.56 KG / 10 LBS



LENGTH
总长
1054 mm
41.5 in.



DEPTH
深度
140 mm
5.5 in.

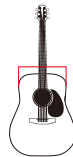

UPPER
BOUT
WIDTH
上桶宽
305 mm
12 in.



LOWER
BOUT
WIDTH
下桶宽
394 mm
15.5 in.

NET WEIGHT / 净重
4.66 KG / 10.3 LBS



LENGTH
总长
991 mm
39 in.



DEPTH
深度
64 mm
2.5 in.

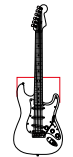

UPPER
BOUT
WIDTH
上桶宽
305 mm
12 in.



LOWER
BOUT
WIDTH
下桶宽
356 mm
14 in.

NET WEIGHT / 净重
3.9 KG / 8.6 LBS

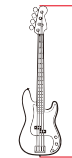

LENGTH
总长
1199 mm
47.2 in.



DEPTH
深度
64 mm
2.5 in.

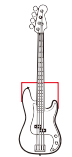

UPPER
BOUT
WIDTH
上桶宽
279 mm
11 in.



LOWER
BOUT
WIDTH
下桶宽
343 mm
13.5 in.

NET WEIGHT / 净重
4.33 KG / 9.55 LBS

MULTI-ANGLE VIEW 多角度视图



PRODUCT HIGHLIGHTS 产品亮点



STRAP PIN PROTECTION

The 40mm thick pad protects the strap pin from shock-damage and it's removable or relocated for different size of body size.

尾钉保护垫

琴包底部约40毫米厚的加强缓冲垫有效防止背带尾钉和琴体在跌落时受到损坏，它也是可以拆卸或放在侧面使用，让琴包可以适用于不同体积的琴体。



HIDEABLE STRAPS

Shoulder straps can be hidden in a pocket to prevent you being stumbled by stepping on them when you carry by the side handle.

肩带收纳袋

琴包背面配有肩带收纳袋，在您不需要使用背带时，可将背带放进收纳袋以防止背带弄脏，同时还能避免您在使用侧面提手时误踩到背带而导致滑倒的隐患。



PADDED NECK CRADLE

The padded neck cradle is firmly in place and the headstock is fully protected against backward drops and side-to-side impacts.

琴颈保护枕

琴包内部配有一个厚实而且软硬适中的琴颈支撑垫，用于保护琴颈和琴头不受晃动或跌落带来的风险，而且它是可以根据不同琴颈的尺寸自由调节最佳的支撑位置。

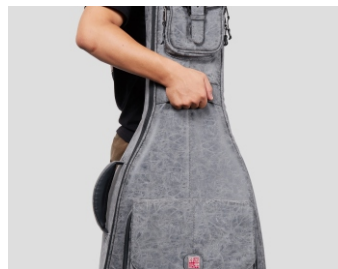

FRONT HANDLE

The front handle allows you to use it uprightly in line to avoid inconveniencing other people by lifting the case with the side-handle.

正面提手

琴包正面设有提手，方便您在人群中或排队时使用，以避免在使用侧面提手时琴包过长而影响到他人。



30MM PADDING
30MM填充厚度



WATER-PROOF
防泼水

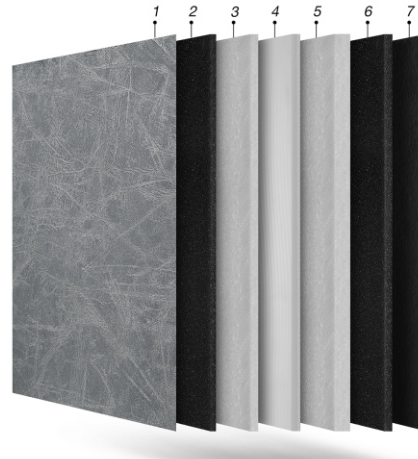

TOP & BACK
(from outer to inner layer)

1. PVC Leather
2. Polyurethane Foam (3mm)
3. EPE (5mm)
4. PP Board (4mm)
5. EPE (10mm)
6. Polyurethane Foam (5mm)
7. Polyester Velboa Fabric

正面和背面
(从表层到里层)

1. PVC皮革
2. PU软泡棉 (3mm)
3. 聚乙烯发泡棉 (5mm)
4. PP加强板 (4mm)
5. 聚乙烯发泡棉 (10mm)
6. PU软泡棉 (5mm)
7. 毛绒布



SIDES
(from outer to inner layer)

1. PVC Leather
2. Polyurethane Foam (3mm)
3. EPE (20mm)
4. Polyurethane Foam (5mm)
5. Polyester Velboa Fabric

侧面
(从表层到里层)

1. PVC皮革
2. PU软泡棉 (3mm)
3. 聚乙烯发泡棉 (20mm)
4. PU软泡棉 (5mm)
5. 毛绒布



HAN30-EG-GRY



HAN30-EG-BN



Music area



WIND30-EG-BLK

WIND30 (BLACK)

风30 (黑色)



CLASSIC GUITAR CASE
古典吉他包

WIND30-CG-BLK



ACOUSTIC GUITAR CASE
民谣吉他包

WIND30-DA-BLK



ELECTRIC GUITAR CASE
电吉他包

WIND30-EG-BLK



BASS GUITAR CASE
贝斯包

WIND30-EB-BLK

MAX DIMENSION OF SUITABLE GUITARS



LENGTH
总长
1066 mm
42 in.



DEPTH
深度
127 mm
5 in.

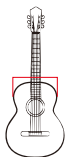

UPPER
BOUT
WIDTH
上桶宽
305 mm
12 in.



LOWER
BOUT
WIDTH
下桶宽
394 mm
15.5 in.

NET WEIGHT / 净重
3.77 KG / 8.3 LBS



LENGTH
总长
1130 mm
44.5 in.



DEPTH
深度
127 mm
5 in.



UPPER
BOUT
WIDTH
上桶宽
305 mm
12 in.



LOWER
BOUT
WIDTH
下桶宽
394 mm
15.5 in.

NET WEIGHT / 净重
3.8 KG / 8.37 LBS



LENGTH
总长
1041 mm
41 in.



DEPTH
深度
56 mm
2.2 in.

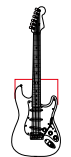

UPPER
BOUT
WIDTH
上桶宽
305 mm
12 in.



LOWER
BOUT
WIDTH
下桶宽
356 mm
14 in.

NET WEIGHT / 净重
3.2 KG / 7.06 LBS

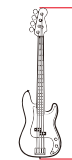

LENGTH
总长
1270 mm
50 in.



DEPTH
深度
56 mm
2.2 in.

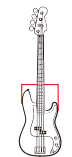

UPPER
BOUT
WIDTH
上桶宽
305 mm
12 in.



LOWER
BOUT
WIDTH
下桶宽
356 mm
14 in.

NET WEIGHT / 净重
3.54 KG / 7.8 LBS

MULTI-ANGLE VIEW 多角度视图



PRODUCT HIGHLIGHTS 产品亮点



STRAP PIN PROTECTION

The 40mm thick pad protects the strap pin from shock-damage and it's removable or relocated for different size of body size.

尾钉保护垫

琴包底部约40毫米厚的加强缓冲垫有效防止背带尾钉和琴体在跌落时受到损坏，它也是可以拆卸或放在侧面使用，让琴包可以适用于不同体积的琴体。

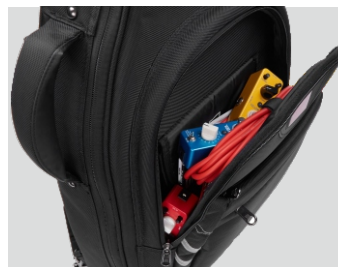

STORAGE POCKETS

There are 6 pockets with several individual compartments of the WIND30 series. You can put almost everything you need for a gig.

储物袋

WIND30系列有6个口袋和几个独立的隔间，您几乎可以放置一场小型演出所需的一切。



PADDED NECK CRADLE

The padded neck cradle is firmly in place and the headstock is fully protected against backward drops and side-to-side impacts.

琴颈保护枕

琴包内部配有一个厚实而且软硬适中的琴颈支撑垫，用于保护琴颈和琴头不受晃动或跌落带来的风险，而且它是可以根据不同琴颈的尺寸自由调节最佳的支撑位置。

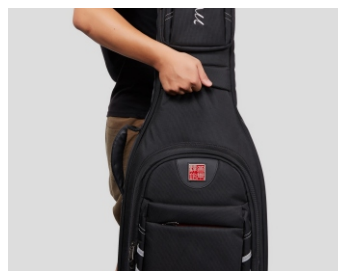

FRONT HANDLE

The front handle allows you to use it uprightly in line to avoid inconveniencing other people by lifting the case with the side-handle.

正面提手

琴包正面设有提手，方便您在人群中或排队时使用，以避免在使用侧面提手时琴包过长而影响到他人。



30MM PADDING
30MM填充厚度



WATER-PROOF
防泼水



TOP & BACK
(from outer to inner layer)

1. 1680D Polyester
2. Polyurethane Foam (5mm)
3. EPE (20mm)
4. Polyurethane Foam (5mm)
5. Polyester Velboa Fabric

正面和背面
(从表层到里层)

1. 聚酯纤维
2. PU软泡棉 (5mm)
3. 聚乙烯发泡棉 (20mm)
4. PU软泡棉 (5mm)
5. 毛绒布

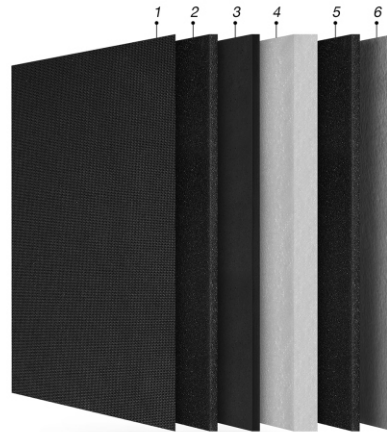

SIDES
(from outer to inner layer)

1. 1680D Polyester
2. Polyurethane Foam (5mm)
3. EVA (5mm)
4. EPE (15mm)
5. Polyurethane Foam (5mm)
6. Polyester Velboa Fabric

侧面
(从表层到里层)

1. 聚酯纤维
2. PU软泡棉 (5mm)
3. EVA (5mm)
4. 聚乙烯发泡棉 (15mm)
5. PU软泡棉 (5mm)
6. 毛绒布



WIND30-EG-GRN

WIND30 (GREEN)

风30 (墨绿色)



CLASSIC GUITAR CASE
古典吉他包

WIND30-CG-GRN



ACOUSTIC GUITAR CASE
民谣吉他包

WIND30-DA-GRN



ELECTRIC GUITAR CASE
电吉他包

WIND30-EG-GRN



BASS GUITAR CASE
贝斯包

WIND30-EB-GRN

MAX DIMENSION OF SUITABLE GUITARS



LENGTH
总长
1066 mm
42 in.



DEPTH
深度
127 mm
5 in.

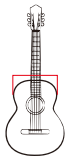

UPPER
BOUT
WIDTH
上桶宽
305 mm
12 in.



LOWER
BOUT
WIDTH
下桶宽
394 mm
15.5 in.

NET WEIGHT / 净重
3.77 KG / 8.3 LBS



LENGTH
总长
1130 mm
44.5 in.



DEPTH
深度
127 mm
5 in.

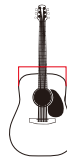

UPPER
BOUT
WIDTH
上桶宽
305 mm
12 in.



LOWER
BOUT
WIDTH
下桶宽
394 mm
15.5 in.

NET WEIGHT / 净重
3.8 KG / 8.37 LBS



LENGTH
总长
1041 mm
41 in.



DEPTH
深度
56 mm
2.2 in.

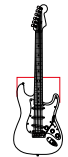

UPPER
BOUT
WIDTH
上桶宽
305 mm
12 in.



LOWER
BOUT
WIDTH
下桶宽
356 mm
14 in.

NET WEIGHT / 净重
3.2 KG / 7.06 LBS



LENGTH
总长
1270 mm
50 in.



DEPTH
深度
56 mm
2.2 in.

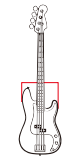

UPPER
BOUT
WIDTH
上桶宽
305 mm
12 in.



LOWER
BOUT
WIDTH
下桶宽
356 mm
14 in.

NET WEIGHT / 净重
3.54 KG / 7.8 LBS

MULTI-ANGLE VIEW 多角度视图



PRODUCT HIGHLIGHTS 产品亮点



STRAP PIN PROTECTION

The 40mm thick pad protects the strap pin from shock-damage and it's removable or relocated for different size of body size.

尾钉保护垫

琴包底部约40毫米厚的加强缓冲垫有效防止背带尾钉和琴体在跌落时受到损坏，它也是可以拆卸或放在侧面使用，让琴包可以适用于不同体积的琴体。



STORAGE POCKETS

There are 6 pockets with several individual compartments of the WIND30 series. You can put almost everything you need for a gig or a tour.

储物袋

WIND30系列有6个口袋和几个独立的隔间。您几乎可以放置演出或巡演所需的一切。



PADDED NECK CRADLE

The padded neck cradle is firmly in place and the headstock is fully protected against backward drops and side-to-side impacts.

琴颈保护枕

琴包内部配有一个厚实而且软硬适中的琴颈支撑垫，用于保护琴颈和琴头不受晃动或跌落带来的风险，而且它是可以根据不同琴颈的尺寸自由调节最佳的支撑位置。



FRONT HANDLE

The front handle allows you to use it uprightly in line to avoid inconveniencing other people by lifting the case with the side-handle.

正面提手

琴包正面设有提手，方便您在人群中或排队时使用，以避免在使用侧面提手时琴包过长而影响到他人。

MATERIAL COMPOSITION 材料构成



30MM PADDING
30MM填充厚度



WATER-PROOF
防泼水



TOP & BACK (from outer to inner layer)

1. 900D Polyester
2. Polyurethane Foam (5mm)
3. EPE (20mm)
4. Polyurethane Foam (5mm)
5. Polyester Velboa Fabric

正面和背面 (从表层到里层)

1. 聚酯纤维
2. PU软泡棉 (5mm)
3. 聚乙烯发泡棉 (20mm)
4. PU软泡棉 (5mm)
5. 毛绒布

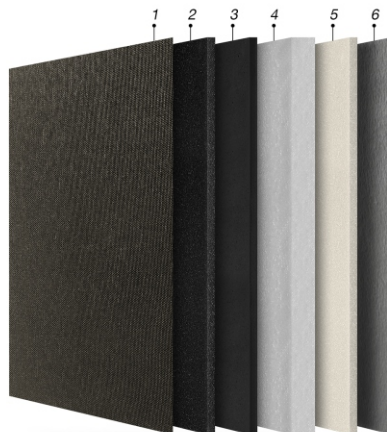

SIDES (from outer to inner layer)

1. 900D Polyester
2. Polyurethane Foam (5mm)
3. EVA (5mm)
4. EPE (15mm)
5. Polyurethane Foam (5mm)
6. Polyester Velboa Fabric

侧面 (从表层到里层)

1. 聚酯纤维
2. PU软泡棉 (5mm)
3. EVA (5mm)
4. 聚乙烯发泡棉 (15mm)
5. PU软泡棉 (5mm)
6. 毛绒布



WIND30-DA-BLK
SIGNATURE VERSION OF CAO SIYI



WIND30-DA-GRN



TANG30-EG-BLK

TANG30 (BLACK)

唐30 (黑色)



**ACOUSTIC+ELECTRIC
COMBO GUITAR CASE**
电木吉他包

TANG30-1A1E-BLK



CLASSIC GUITAR CASE
古典吉他包

TANG30-CG-BLK



ACOUSTIC GUITAR CASE
民谣吉他包

TANG30-DA-BLK



ELECTRIC GUITAR CASE
电吉他包

TANG30-EG-BLK



BASS GUITAR CASE
贝斯包

TANG30-EB-BLK

MAX DIMENSION OF SUITABLE GUITARS

ACOUSTIC GUITAR DEPTH 木吉他深度		ELECTRIC GUITAR DEPTH 电吉他深度		UPPER BOUT WIDTH 上桶宽		LOWER BOUT WIDTH 下桶宽		NET WEIGHT / 净重	
	LENGTH 总长 1067 mm 42 in.		LENGTH 总长 1054 mm 41.5 in.		UPPER BOUT WIDTH 上桶宽 305 mm 12 in.		LOWER BOUT WIDTH 下桶宽 406 mm 16 in.	3.86 KG / 8.5 LBS	
	DEPTH 深度 127 mm 5 in.		DEPTH 深度 51 mm 2 in.		UPPER BOUT WIDTH 上桶宽 279 mm 11 in.		LOWER BOUT WIDTH 下桶宽 368 mm 14.5 in.	2.71 KG / 5.98 LBS	
	LENGTH 总长 1054 mm 41.5 in.		LENGTH 总长 1054 mm 41.5 in.		UPPER BOUT WIDTH 上桶宽 305 mm 12 in.		LOWER BOUT WIDTH 下桶宽 394 mm 15.5 in.	2.86 KG / 6.31 LBS	
	LENGTH 总长 1054 mm 41.5 in.		DEPTH 深度 51 mm 2 in.		UPPER BOUT WIDTH 上桶宽 279 mm 11 in.		LOWER BOUT WIDTH 下桶宽 356 mm 14 in.	2.42 KG / 5.34 LBS	
	LENGTH 总长 1219 mm 48 in.		DEPTH 深度 51 mm 2 in.		UPPER BOUT WIDTH 上桶宽 279 mm 11 in.		LOWER BOUT WIDTH 下桶宽 381 mm 15 in.	2.65 KG / 5.84 LBS	

MULTI-ANGLE VIEW 多角度视图



PRODUCT HIGHLIGHTS 产品亮点



STRAP PIN PROTECTION

The 40mm thick pad protects the strap pin from shock-damage and it's removable or relocated for different size of body size.

尾钉保护垫

琴包底部约40毫米厚的加强缓冲垫有效防止背带尾钉和琴体在跌落时受到损坏，它也是可以拆卸或放在侧面使用，让琴包可以适用于不同体积的琴体。



HIDEABLE STRAPS

Shoulder straps can be hidden in a pocket to prevent you being stumbled by stepping on them when you carry by the side handle.

肩带收纳袋

琴包背面配有肩带收纳袋，在您不需要使用背带时，可将背带放进收纳袋以防止背带弄脏，同时还能避免您在使用侧面提手时误踩到背带而导致滑倒的隐患。



PADDED NECK CRADLE

The padded neck cradle is firmly in place and the headstock is fully protected against backward drops and side-to-side impacts.

琴颈保护枕

琴包内部配有一个厚实而且软硬适中的琴颈支撑垫，用于保护琴颈和琴头不受晃动或跌落带来的风险，而且它是可以根据不同琴颈的尺寸自由调节最佳的支撑位置。

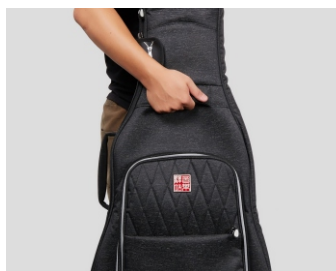

FRONT HANDLE

The front handle allows you to use it uprightly in line to avoid inconveniencing other people by lifting the case with the side-handle.

正面提手

琴包正面设有提手，方便您在人群中或排队时使用，以避免在使用侧面提手时琴包过长而影响到他人。

ACOUSTIC+ELECTRIC COMBO GUITAR CASE 唐30电木组合包



BACKPACK SYSTEM FOR ACOUSTIC GUITARS HARD-CASE 原声吉他木箱背负系统

TANG30-HCBP-BLK



MATERIAL COMPOSITION 材料构成



30MM PADDING
30MM填充厚度



WATER-PROOF
防泼水



TOP & BACK (from outer to inner layer)

1. 900D Polyester
2. Polyurethane Foam (5mm)
3. EPE (20mm)
4. Polyurethane Foam (5mm)
5. Polyester Velboa Fabric

正面和背面 (从表层到里层)

1. 聚酯纤维
2. PU软泡棉 (5mm)
3. 聚乙烯发泡棉 (20mm)
4. PU软泡棉 (5mm)
5. 毛绒布



SIDES (from outer to inner layer)

1. 900D Polyester
2. Polyurethane Foam (5mm)
3. EVA (5mm)
4. EPE (15mm)
5. Polyurethane Foam (5mm)
6. Polyester Velboa Fabric

侧面 (从表层到里层)

1. 聚酯纤维
2. PU软泡棉 (5mm)
3. EVA (5mm)
4. 聚乙烯发泡棉 (15mm)
5. PU软泡棉 (5mm)
6. 毛绒布



TANG30-1A1E-BLK



TANG30-EG-GRY

TANG30 (GREY)

唐30 (灰色)



CLASSIC GUITAR CASE
古典吉他包

TANG30-CG-GRY



ACOUSTIC GUITAR CASE
民谣吉他包

TANG30-DA-GRY



ELECTRIC GUITAR CASE
电吉他包

TANG30-EG-GRY



BASS GUITAR CASE
贝斯包

TANG30-EB-GRY

MAX DIMENSION OF SUITABLE GUITARS



LENGTH
总长
1041 mm
41 in.



DEPTH
深度
127 mm
5 in.

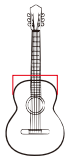

UPPER
BOUT
WIDTH
上桶宽
279 mm
11 in.



LOWER
BOUT
WIDTH
下桶宽
368 mm
14.5 in.

NET WEIGHT / 净重
2.71 KG / 5.98 LBS



LENGTH
总长
1054 mm
41.5 in.



DEPTH
深度
127 mm
5 in.

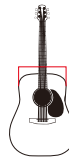

UPPER
BOUT
WIDTH
上桶宽
305 mm
12 in.



LOWER
BOUT
WIDTH
下桶宽
394 mm
15.5 in.

NET WEIGHT / 净重
2.86 KG / 6.31 LBS



LENGTH
总长
1054 mm
41.5 in.



DEPTH
深度
51 mm
2 in.

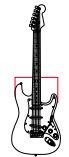

UPPER
BOUT
WIDTH
上桶宽
279 mm
11 in.



LOWER
BOUT
WIDTH
下桶宽
356 mm
14 in.

NET WEIGHT / 净重
2.42 KG / 5.34 LBS

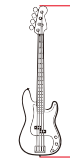

LENGTH
总长
1219 mm
48 in.



DEPTH
深度
51 mm
2 in.

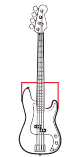

UPPER
BOUT
WIDTH
上桶宽
279 mm
11 in.



LOWER
BOUT
WIDTH
下桶宽
381 mm
15 in.

NET WEIGHT / 净重
2.65 KG / 5.84 LBS

MULTI-ANGLE VIEW 多角度视图



PRODUCT HIGHLIGHTS 产品亮点



STRAP PIN PROTECTION

The 40mm thick pad protects the strap pin from shock-damage and it's removable or relocated for different size of body size.

尾钉保护垫

琴包底部约40毫米厚的加强缓冲垫有效防止背带尾钉和琴体在跌落时受到损坏，它也是可以拆卸或放在侧面使用，让琴包可以适用于不同体积的琴体。



HIDEABLE STRAPS

Shoulder straps can be hidden in a pocket to prevent you being stumbled by stepping on them when you carry by the side handle.

肩带收纳袋

琴包背面配有肩带收纳袋，在您不需要使用背带时，可将背带放进收纳袋以防止背带弄脏，同时还能避免您在使用侧面提手时误踩到背带而导致滑倒的隐患。



PADDED NECK CRADLE

The padded neck cradle is firmly in place and the headstock is fully protected against backward drops and side-to-side impacts.

琴颈保护枕

琴包内部配有一个厚实而且软硬适中的琴颈支撑垫，用于保护琴颈和琴头不受晃动或跌落带来的风险，而且它是可以根据不同琴颈的尺寸自由调节最佳的支撑位置。

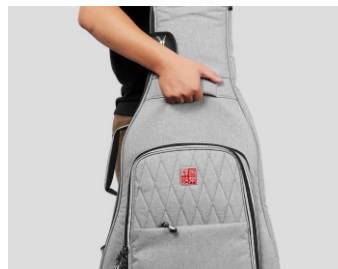

FRONT HANDLE

The front handle allows you to use it uprightly in line to avoid inconveniencing other people by lifting the case with the side-handle.

正面提手

琴包正面设有提手，方便您在人群中或排队时使用，以避免在使用侧面提手时琴包过长而影响到他人。



30MM PADDING
30MM填充厚度



WATER-PROOF
防泼水



TOP & BACK
(from outer to inner layer)

1. 900D Polyester
2. Polyurethane Foam (5mm)
3. EPE (20mm)
4. Polyurethane Foam (5mm)
5. Polyester Velboa Fabric

正面和背面
(从表层到里层)

1. 聚酯纤维
2. PU软泡棉 (5mm)
3. 聚乙烯发泡棉 (20mm)
4. PU软泡棉 (5mm)
5. 毛绒布

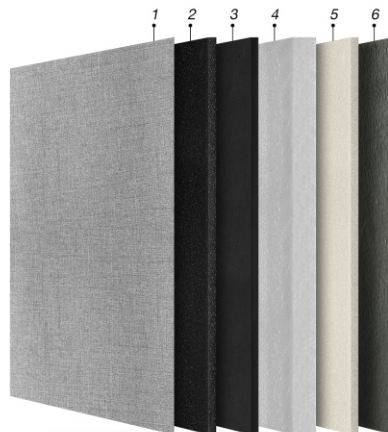

SIDES
(from outer to inner layer)

1. 900D Polyester
2. Polyurethane Foam (5mm)
3. EVA (5mm)
4. EPE (15mm)
5. Polyurethane Foam (5mm)
6. Polyester Velboa Fabric

侧面
(从表层到里层)

1. 聚酯纤维
2. PU软泡棉 (5mm)
3. EVA (5mm)
4. 聚乙烯发泡棉 (15mm)
5. PU软泡棉 (5mm)
6. 毛绒布



Music stand



TANG30-EG-BLK



TANG30-1A1E-BLK



RB30-EG-BLK

RB30 (BLACK)

精英30 (黑色)



CLASSIC GUITAR CASE
古典吉他包

RB30-CG-BLK



ACOUSTIC GUITAR CASE
民谣吉他包

RB30-DA-BLK



ELECTRIC GUITAR CASE
电吉他包

RB30-EG-BLK



BASS GUITAR CASE
贝斯包

RB30-EB-BLK

MAX DIMENSION OF SUITABLE GUITARS



LENGTH
总长
1067 mm
42 in.



DEPTH
深度
127 mm
5 in.

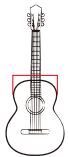

UPPER
BOUT
WIDTH
上桶宽
331 mm
13 in.



LOWER
BOUT
WIDTH
下桶宽
381 mm
15 in.

NET WEIGHT / 净重
3.9 KG / 8.6 LBS



LENGTH
总长
1131 mm
44.5 in.



DEPTH
深度
127 mm
5 in.

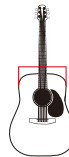

UPPER
BOUT
WIDTH
上桶宽
331 mm
13 in.



LOWER
BOUT
WIDTH
下桶宽
419 mm
16.5 in.

NET WEIGHT / 净重
4.1 KG / 9.04 LBS



LENGTH
总长
1016 mm
40 in.



DEPTH
深度
64 mm
2.5 in.

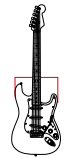

UPPER
BOUT
WIDTH
上桶宽
318 mm
12.5 in.



LOWER
BOUT
WIDTH
下桶宽
343 mm
13.5 in.

NET WEIGHT / 净重
3.5 KG / 7.72 LBS

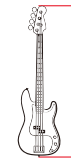

LENGTH
总长
1245 mm
49 in.



DEPTH
深度
64 mm
2.5 in.

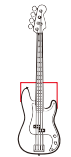

UPPER
BOUT
WIDTH
上桶宽
331 mm
13 in.



LOWER
BOUT
WIDTH
下桶宽
356 mm
14 in.

NET WEIGHT / 净重
3.9 KG / 8.6 LBS

MULTI-ANGLE VIEW 多角度视图



PRODUCT HIGHLIGHTS 产品亮点



STRAP PIN PROTECTION

The 40mm thick pad protects the strap pin from shock-damage and it's removable or relocated for different size of body size.

尾钉保护垫

琴包底部约40毫米厚的加强缓冲垫有效防止背带尾钉和琴体在跌落时受到损坏，它也是可以拆卸或放在侧面使用，让琴包可以适用于不同体积的琴体。



HIDEABLE STRAPS

Shoulder straps can be hidden in a pocket to prevent you being stumbled by stepping on them when you carry by the side handle.

肩带收纳袋

琴包背面配有肩带收纳袋，在您不需要使用背带时，可将背带放进收纳袋以防止背带弄脏，同时还能避免您在使用侧面提手时误踩到背带而导致滑倒的隐患。



PADDED NECK CRADLE

Two padded neck cradles are firmly in place so the headstock is fully protected against backward drops and side-to-side impacts.

琴颈保护枕

琴包内部配有一个厚实的琴颈支撑垫，用于保护琴颈和琴头不受晃动或跌落带来的风险，其中一个是可以根据不同琴颈的尺寸调节最佳的支撑位置。

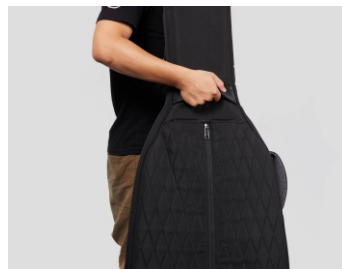

BACK HANDLE

The back handle allows you to hold the case uprightly to avoid inconveniencing other people by carrying with the side handle.

背面提手

琴包背面设有提手，方便您在人群中或排队时使用，以避免在使用侧面提手时琴包过长而影响他人。



DETACHABLE ISOTHERMIC BAG

RB30 series comes with a free detachable isothermic bag which is fixed with velcro belts in 4 positions. The inner lining of the isothermic bag is made of high-quality aluminum foil, which is soft and smooth, super bright and highly reflective. It maintains the temperature of its contents up to 6 to 8 hours, keeping cold items cold, and hot items hot.

可拆卸恒温包

RB30吉他贝斯系列附赠一个可拆卸恒温包，无需额外购买，它由四个魔术贴固定在琴包上。恒温包的里布采用的是一种具有隔热、恒温效果的铝箔材料，具有冬暖夏凉的特点，您可以存放效果器、话筒等设备，也可以用于存放啤酒、可乐等饮料。

MATERIAL COMPOSITION 材料构成



30MM PADDING
30MM填充厚度



WATER-PROOF
防泼水

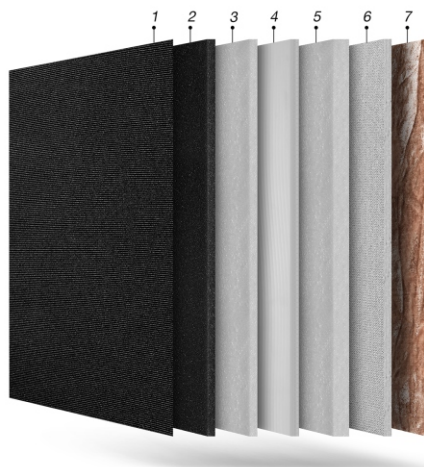

TOP & BACK (from outer to inner layer)

1. 900D*400D Polyester
2. Polyurethane Foam (5mm)
3. EPE (5mm)
4. PP Reinforcing Plate (4mm)
5. EPE (10mm)
6. Polyurethane Foam (5mm)
7. Plush

正面和背面 (从表层到里层)

1. 聚酯纤维
2. PU软泡棉 (5mm)
3. 聚乙烯发泡棉 (5mm)
4. PP加强板 (4mm)
5. 聚乙烯发泡棉 (10mm)
6. PU软泡棉 (5mm)
7. 金丝绒



SIDES (from outer to inner layer)

1. 900D*400D Polyester
2. Polyurethane Foam (5mm)
3. EPE (20mm)
4. Polyurethane Foam (5mm)
5. Plush

侧面 (从表层到里层)

1. 聚酯纤维
2. PU软泡棉 (5mm)
3. 聚乙烯发泡棉 (20mm)
4. PU软泡棉 (5mm)
5. 金丝绒



工业站

Gongye Xie Zhuan

RB30-EG-BLK



RB30-EG-BLK



RB30-EG-BLK



WIND20-DA-BLK

WIND20 (BLACK)

风20 (黑色)



36" GUITAR CASE
36寸吉他包

WIND20-34-BLK



CLASSIC GUITAR CASE
古典吉他包

WIND20-CG-BLK



ACOUSTIC GUITAR CASE
民谣吉他包

WIND20-DA-BLK



ELECTRIC GUITAR CASE
电吉他包















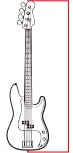

WIND20-EG-BLK

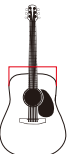

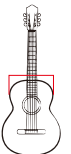
BASS GUITAR CASE
贝斯包

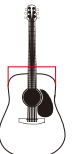
WIND20-EB-BLK

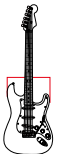
MAX DIMENSION OF SUITABLE GUITARS

36" GUITAR CASE		CLASSIC GUITAR CASE		ACOUSTIC GUITAR CASE		ELECTRIC GUITAR CASE		BASS GUITAR CASE							
	LENGTH 总长 940 mm 37 in.		DEPTH 深度 114 mm 4.5 in.		LENGTH 总长 1003 mm 39.5 in.		DEPTH 深度 127 mm 5 in.		LENGTH 总长 1029 mm 40.5 in.		DEPTH 深度 51 mm 2 in.		LENGTH 总长 1207 mm 47.5 in.		DEPTH 深度 51 mm 2 in.
	UPPER BOUT WIDTH 上桶宽 254 mm 10 in.		LOWER BOUT WIDTH 下桶宽 356 mm 14 in.		UPPER BOUT WIDTH 上桶宽 279 mm 11 in.		LOWER BOUT WIDTH 下桶宽 369 mm 14.5 in.		UPPER BOUT WIDTH 上桶宽 305 mm 12 in.		LOWER BOUT WIDTH 下桶宽 394 mm 15.5 in.		UPPER BOUT WIDTH 上桶宽 279 mm 11 in.		LOWER BOUT WIDTH 下桶宽 356 mm 14 in.
NET WEIGHT / 净重 2.18 KG / 4.8 LBS		NET WEIGHT / 净重 2.34 KG / 5.2 LBS		NET WEIGHT / 净重 2.86 KG / 6.31 LBS		NET WEIGHT / 净重 2.08 KG / 4.59 LBS		NET WEIGHT / 净重 2.16 KG / 4.76 LBS							

MULTI-ANGLE VIEW 多角度视图



PRODUCT HIGHLIGHTS 产品亮点



SHOULDER STRAPS

S-shaped shoulder straps with massage cushions are ergonomically designed to reduce the burden on the shoulders.

双肩背带

符合人体工程学设计的S型双肩带采用透气记忆棉为主，搭配耐磨的面料与专业的缝绉技术让肩带舒适而且坚固。



WATER-PROOF MATERIAL

The waterproof coating on the surface and PVC coating on the opposite side effectively prevents the liquid from infiltrating into the case.

防水材料

琴包表面材料加入了防水涂层，面料的反面加有PVC涂层，可以有效防止液体渗入包中。



PADDED NECK CRADLE

The padded neck cradle is firmly in place and the headstock is fully protected against backward drops and side-to-side impacts.

琴颈保护枕

琴包内部配有一个厚实而且软硬适中的琴颈支撑垫，用于保护琴颈和琴头不受晃动或跌落带来的风险，而且它是可以根据不同琴颈的尺寸自由调节最佳的支撑位置。



HARD-WEARING PVC PAD

Wavy shaped bottom pad with PVC hard-wearing molecules which is wear-resistant and anti-aging protects the case bottom very well.

PVC防磨底垫

底部配有波浪型设计并含有聚氯乙烯耐磨分子的防磨损塑胶垫，能有效保护琴包底部。

MATERIAL COMPOSITION 材料构成



30MM PADDING
30MM填充厚度



WATER-PROOF
防泼水

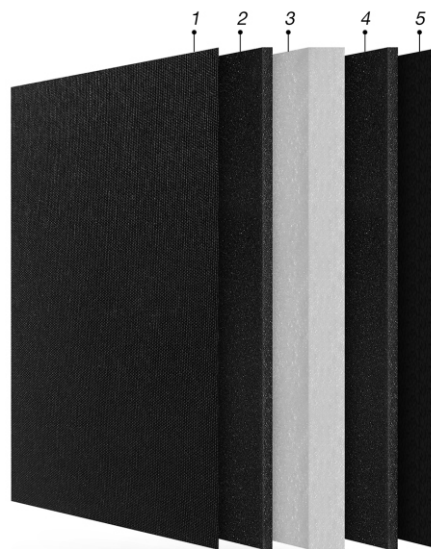

TOP & BACK & SIDES (from outer to inner layer)

1. 900D Polyester
2. Polyurethane Foam (5mm)
3. EPE (20mm)
4. Polyurethane Foam (5mm)
5. Polyester Velboa Fabric

正面和背面和侧面 (从表层到里层)

1. 聚酯纤维
2. PU软泡棉 (5mm)
3. 聚乙烯发泡棉 (20mm)
4. PU软泡棉 (5mm)
5. 毛绒布



WIND20-DA-GEN

WIND20 (GREEN)

风20 (墨绿色)



CLASSIC GUITAR CASE
古典吉他包

WIND20-CG-GRN



ACOUSTIC GUITAR CASE
民谣吉他包

WIND20-DA-GRN



ELECTRIC GUITAR CASE
电吉他包

WIND20-EG-GRN



BASS GUITAR CASE
贝斯包

WIND20-EB-GRN

MAX DIMENSION OF SUITABLE GUITARS



LENGTH
总长
1066 mm
42 in.



DEPTH
深度
127 mm
5 in.

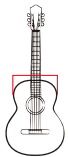

UPPER
BOUT
WIDTH
上桶宽
305 mm
12 in.



LOWER
BOUT
WIDTH
下桶宽
394 mm
15.5 in.

NET WEIGHT / 净重
3.77 KG / 8.3 LBS



LENGTH
总长
1130 mm
44.5 in.



DEPTH
深度
127 mm
5 in.

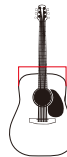

UPPER
BOUT
WIDTH
上桶宽
305 mm
12 in.



LOWER
BOUT
WIDTH
下桶宽
394 mm
15.5 in.

NET WEIGHT / 净重
3.8 KG / 8.4 LBS



LENGTH
总长
1029 mm
40.5 in.



DEPTH
深度
51 mm
2 in.

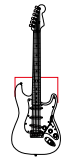

UPPER
BOUT
WIDTH
上桶宽
279 mm
11 in.



LOWER
BOUT
WIDTH
下桶宽
356 mm
14 in.

NET WEIGHT / 净重
2.08 KG / 4.59 LBS



LENGTH
总长
1207 mm
47.5 in.



DEPTH
深度
21 mm
2 in.

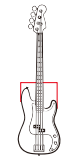

UPPER
BOUT
WIDTH
上桶宽
279 mm
11 in.



LOWER
BOUT
WIDTH
下桶宽
381 mm
15 in.

NET WEIGHT / 净重
2.16 KG / 4.76 LBS

MULTI-ANGLE VIEW 多角度视图



PRODUCT HIGHLIGHTS 产品亮点



PADDED NECK CRADLE

The padded neck cradle is firmly in place and the headstock is fully protected against backward drops and side-to-side impacts.

琴颈保护枕

琴包内部配有一个厚实而且软硬适中的琴颈支撑垫，用于保护琴颈和琴头不受晃动或跌落带来的风险，而且它是可以根据不同琴颈的尺寸自由调节最佳的支撑位置。



WATER-PROOF MATERIAL

The waterproof coating on the surface and PVC coating on the opposite side effectively prevents the liquid from infiltrating into the case.

防水材料

琴包表面材料加入了防水涂层，面料的反面加有PVC涂层，可以有效防止液体渗入包中。



BACK HANDLE

The back handle allows you to hold the case upright to avoid inconveniencing other people by carrying with the side handle.

背面提手

琴包背面设有提手，方便您在人群中或排队时使用，以避免在使用侧面提手时琴包过长而影响到他人。



SHOULDER STRAPS

S-shaped shoulder straps with massage cushions are ergonomically designed to reduce the burden on the shoulders.

双肩背带

带按摩垫的S形双肩背带符合人体工程学设计，可减轻肩部负担。



30MM PADDING
30MM填充厚度



WATER-PROOF
防泼水



TOP & BACK & SIDES
(from outer to inner layer)

1. 900D Polyester
2. Polyurethane Foam (5mm)
3. EPE (20mm)
4. Polyurethane Foam (5mm)
5. Polyester Velboa Fabric

正面和背面和侧面
(从表层到里层)

1. 聚酯纤维
2. PU软泡棉 (5mm)
3. 聚乙烯发泡棉 (20mm)
4. PU软泡棉 (5mm)
5. 毛绒布



WIND20-DA-BLK



WIND20-DA-GEN



RB20-DA-BLK

RB20 (BLACK)

精英20 (黑色)



36" GUITAR CASE
36寸吉他包
RB20-34-BLK



CLASSIC GUITAR CASE
古典吉他包
RB20-CG-BLK



ACOUSTIC GUITAR CASE
民谣吉他包
RB20-DA-BLK

















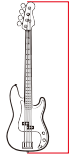

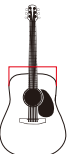
ELECTRIC GUITAR CASE
电吉他包
RB20-EG-BLK

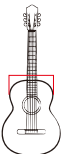

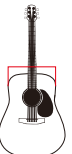
BASS GUITAR CASE
贝斯包
RB20-EB-BLK

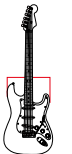
MAX DIMENSION OF SUITABLE GUITARS

36" GUITAR CASE		CLASSIC GUITAR CASE		ACOUSTIC GUITAR CASE		ELECTRIC GUITAR CASE		BASS GUITAR CASE							
	LENGTH 总长 927 mm 36.5 in.		DEPTH 深度 101 mm 4 in.		LENGTH 总长 965 mm 38 in.		DEPTH 深度 127 mm 5 in.		LENGTH 总长 1029 mm 40.5 in.		DEPTH 深度 51 mm 2 in.		LENGTH 总长 1143 mm 45 in.		DEPTH 深度 51 mm 2 in.
	UPPER BOUT WIDTH 上桶宽 241 mm 9.5 in.		LOWER BOUT WIDTH 下桶宽 330 mm 13 in.		UPPER BOUT WIDTH 上桶宽 267 mm 10.5 in.		LOWER BOUT WIDTH 下桶宽 368 mm 14.5 in.		UPPER BOUT WIDTH 上桶宽 292 mm 11.5 in.		LOWER BOUT WIDTH 下桶宽 399 mm 15.7 in.		UPPER BOUT WIDTH 上桶宽 279 mm 11 in.		LOWER BOUT WIDTH 下桶宽 356 mm 14 in.
NET WEIGHT / 净重 1.6 KG / 3.5 LBS		NET WEIGHT / 净重 1.81 KG / 3.99 LBS		NET WEIGHT / 净重 1.87 KG / 4.12 LBS		NET WEIGHT / 净重 1.51 KG / 3.33 LBS		NET WEIGHT / 净重 1.72 KG / 3.79 LBS							

MULTI-ANGLE VIEW 多角度视图



PRODUCT HIGHLIGHTS 产品亮点



PADDED NECK CRADLE

The padded neck cradle is firmly in place and the headstock is fully protected against backward drops and side-to-side impacts.

琴颈保护枕

琴包内部配有一个厚实而且软硬适中的琴颈支撑垫，用于保护琴颈和琴头不受晃动或跌落带来的风险，而且它是可以根据不同琴颈的尺寸自由调节最佳的支撑位置。



WATER-PROOF MATERIAL

The waterproof coating on the surface and PVC coating on the opposite side effectively prevents the liquid from infiltrating into the case.

防水材料

琴包表面材料加入了防水涂层，面料的反面加有PVC涂层，可以有效防止液体渗入包中。

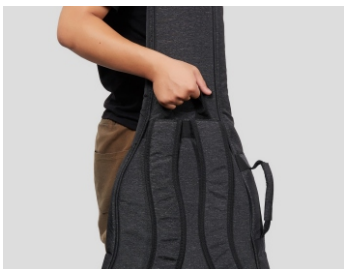

BACK HANDLE

The back handle allows you to hold the case upright to avoid inconveniencing other people by carrying with the side handle.

背面提手

琴包背面设有提手，方便您在人群中或排队时使用，以避免在使用侧面提手时琴包过长而影响到他人。



SHOULDER STRAPS

S-shaped shoulder straps with massage cushions are ergonomically designed to reduce the burden on the shoulders.

双肩背带

带按摩垫的S形双肩背带符合人体工程学设计，可减轻肩部负担。

MATERIAL COMPOSITION 材料构成



20MM PADDING
20MM填充厚度



WATER-PROOF
防泼水

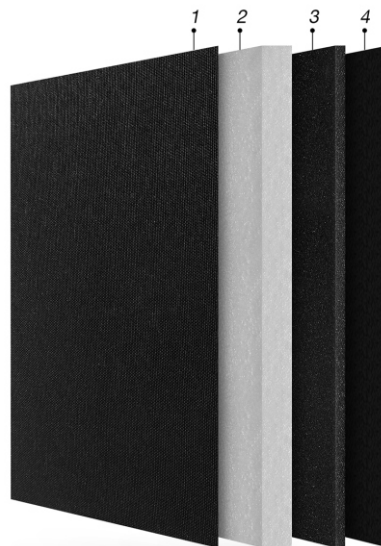

TOP & BACK & SIDES (from outer to inner layer)

1. Polyester (900D) (Waterproof)
2. EPE (15mm)
3. Polyurethane Foam (5mm)
4. Polyester Velboa Fabric

正面和背面和侧面 (从表层到里层)

1. 聚酯纤维
2. 聚乙烯发泡棉 (15mm)
3. 软泡棉PU (5mm)
4. 毛绒布



RB10-DA-BLK

RB10 (BLACK)

精英10 (黑色)



ACOUSTIC GUITAR CASE
民谣吉他包









RB10-DA-BLK

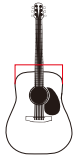

ELECTRIC GUITAR CASE
电吉他包

RB10-EG-BLK

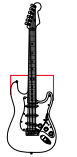
MAX DIMENSION OF SUITABLE GUITARS

 <p>LENGTH 总长 1029 mm 40.5 in.</p>	 <p>DEPTH 深度 127 mm 5 in.</p>	 <p>LENGTH 总长 1029 mm 40.5 in.</p>	 <p>DEPTH 深度 51 mm 2 in.</p>
 <p>UPPER BOUT WIDTH 上桶宽 292 mm 11.5 in.</p>	 <p>LOWER BOUT WIDTH 下桶宽 381 mm 15 in.</p>	 <p>UPPER BOUT WIDTH 上桶宽 279 mm 11 in.</p>	 <p>LOWER BOUT WIDTH 下桶宽 356 mm 14 in.</p>
<p>NET WEIGHT / 净重 1.1 KG / 2.4 LBS</p>		<p>NET WEIGHT / 净重 1.05 KG / 2.3 LBS</p>	

MULTI-ANGLE VIEW 多角度视图



PRODUCT HIGHLIGHTS 产品亮点



BACK HANDLE

The back handle allows you to hold the case uprightly to avoid inconveniencing other people by carrying with the side handle.

背面提手

琴包背面设有提手，方便您在人群中或排队时使用，以避免在使用侧面提手时琴包过长而影响他人。



SHOULDER STRAPS

S-shaped shoulder straps with massage cushions are ergonomically designed to reduce the burden on the shoulders.

双肩背带

带按摩垫的S形双肩背带符合人体工程学设计，可减轻肩部负担。



WATER-PROOF MATERIAL

The waterproof coating on the surface and PVC coating on the opposite side effectively prevents the liquid from infiltrating into the case.

防水材料

琴包表面材料加入了防水涂层，面料的反面加有PVC涂层，可以有效防止液体渗入包中。



INDUSTRIAL ZIPPERS

All Music Area zippers have passed the mechanical tests by zipping and unzipping over 8000 times.

工业级拉链

所有音乐驿站产品的拉链都通过了八千次的拉合测试。

MATERIAL COMPOSITION 材料构成



10MM PADDING
10MM填充厚度



WATER-PROOF
防泼水

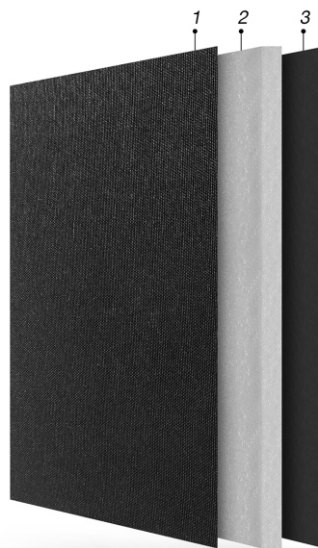

TOP & BACK & SIDES (from outer to inner layer)

1. 900D Polyester
2. EPE (10mm)
3. 70D / PU

正面和背面和侧面 (从表层到里层)

1. 聚酯纤维
2. 聚乙烯发泡棉 (10mm)
3. 70D / PU

SNARE CASE

军鼓包



SNARE CASE
军鼓包
RB-SNR714-BLK

MAX DIMENSION OF SUITABLE SNARES

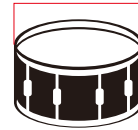

DIAMETER
直径
356 mm
14 in.

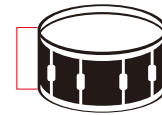

DEPTH
深度
178 mm
7 in.

NET WEIGHT / 净重
2.3 KG / 5 LBS

MULTI-ANGLE VIEW 多角度视图



MATERIAL COMPOSITION 材料构成



22MM PADDING
22MM内部填充物



WATER-PROOF
防泼水

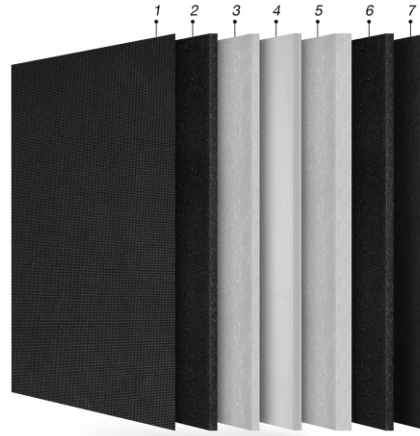

TOP & BACK (from outer to inner layer)

1. 900D Polyester
2. Polyurethane Foam (5mm)
3. EPE (5mm)
4. PE Board (1.5mm)
5. EPE (5mm)
6. Polyurethane Foam (5mm)
7. Polyester Velboa Fabric

正面和背面 (从表层到里层)

1. 聚酯纤维
2. PU软泡棉 (5mm)
3. 聚乙烯发泡棉 (5mm)
4. PE板 (1.5mm)
5. 聚乙烯发泡棉 (5mm)
6. PU软泡棉 (5mm)
7. 毛绒布

PRODUCT HIGHLIGHTS 产品亮点



**WEARPROOF
FOOT PADS**
防滑耐磨脚垫



**PROTECTION FOR
SNARE STRAINER**
响簧调节器保护



**OPEN IN
BOTH SIDES**
双面可拆卸



**SINGLE SHOULDER
STRAP**
单肩背带



RB-SNR714-BLK



樂音
樂站

樂音
樂站

MEINL

RB-CY22-BLK



CYMBAL CASE

镲片包

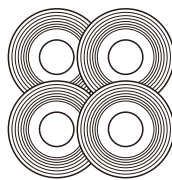

CYMBAL CASE
镲片包
RB-CY22-BLK

MAX DIMENSION OF SUITABLE CYMBALS

 <p>Cymbals x 4 pcs 镲片 x 4片</p>	<p>MAX DIA 最大直径 560 mm 22 in.</p>		<p>MAX DIA 最大直径 380 mm 15 in.</p>
<p>NET WEIGHT / 净重 2.1 KG / 4.6 LBS</p>			

MULTI-ANGLE VIEW 多角度视图



MATERIAL COMPOSITION 材料构成



25MM PADDING
25MM内部填充物



WATER-PROOF
防泼水

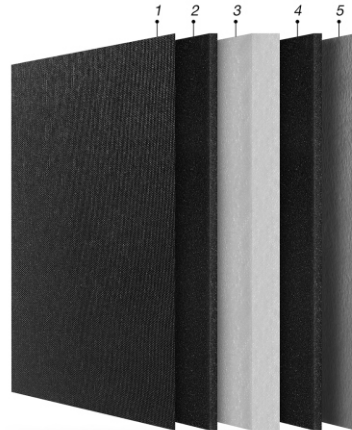

TOP & BACK & SIDES (from outer to inner layer)

1. 900D Polyester
2. Polyurethane Foam (5mm)
3. EPE (15mm)
4. Polyurethane Foam (5mm)
5. Polyester Velboa Fabric

正面和背面和侧面 (从表层到里层)

1. 聚酯纤维
2. PU软泡棉 (5mm)
3. 聚乙烯发泡棉 (15mm)
4. PU软泡棉 (5mm)
5. 毛绒布

PRODUCT HIGHLIGHTS 产品亮点

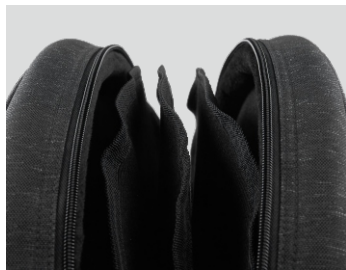

INTERLAYER FOR
4 CYMBALS
四个独立的镲片隔层



INTERLAYER FOR
1 PAIR HI-HAT
一对踩镲隔层



BACKPACK SHOULDER
STRAP
双肩背带



SINGLE SHOULDER
STRAP
单肩背带



RB-DSL-BLK

DRUM STICK CASE

鼓棒包

DRUM STICK CASE (L)

大鼓棒包

RB-DSL-BLK



DRUM STICK CASE (S)

小鼓棒包

RB-DSS-BLK





EQUINOX
EST. 1983
EQUINOX

KEYBOARD CASES

键盘包



61-KEY KEYBOARD CASE
61键键盘包

RB30-KEY61-BLK

MAX DIMENSION OF
SUITABLE KEYBOARDS



LENGTH 总长	WIDTH 宽	DEPTH 深
1040 mm 41 in.	320 mm 12.6 in.	127 mm 5 in.



76-KEY KEYBOARD CASE
76键键盘包

RB30-KEY76-BLK



LENGTH 总长	WIDTH 宽	DEPTH 深
1122 mm 44 in.	347 mm 13.7 in.	127 mm 5 in.



88-KEY KEYBOARD CASE
88键键盘包

RB30-KEY88-BLK



LENGTH 总长	WIDTH 宽	DEPTH 深
1330 mm 52.3 in.	347 mm 13.7 in.	127 mm 5 in.

WHEELS
带脚轮

MATERIAL COMPOSITION 材料构成



30MM PADDING
30MM内部填充物



WATER-PROOF
防泼水



SIDES (from outer to inner layer)

1. 900D*400D Polyester
2. Polyurethane Foam (5mm)
3. EPE (20mm)
4. Polyurethane Foam (5mm)
5. Plush

侧面 (从表层到里层)

1. 聚酯纤维
2. PU软泡棉 (5mm)
3. 聚乙烯发泡棉 (20mm)
4. PU软泡棉 (5mm)
5. 金丝绒

PRODUCT HIGHLIGHTS 产品亮点



RIVETED HANDLES ON BOTH SIDES

两侧双人提手



RIVETED MIDDLE SIDE HANDLE

中间单人提手



SINGLE SHOULDER STRAP

单肩背带



COMFORTABLE PLUSH LINING

金丝绒里衬

FOOTHOLDS AND WHEELS 脚垫和脚轮



THE RB30-KEY88-BLK
COMES WITH WHEELS
88键包带有胶垫和脚轮，方便一
个人的携带





WIND20-23UK-GRN

UKULELE CASES

尤克里里包



23" UKULELE CASE 23寸尤克里里包

WIND20-23UK-GRN

WIND20-23UK-BLK

WIND20-23UK-GRY

27" UKULELE CASE 27寸尤克里里包

WIND20-27UK-GRN

WIND20-27UK-BLK

WIND20-27UK-GRY

MAX DIMENSION OF SUITABLE UKULELES



LENGTH
总长
648 mm
25.5 in.



DEPTH
深度
76 mm
3 in.

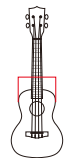

UPPER
BOUT
WIDTH
上桶宽
140 mm
5.5 in.



LOWER
BOUT
WIDTH
下桶宽
191 mm
7.5 in.



LENGTH
总长
686 mm
27 in.



DEPTH
深度
104 mm
4 in.

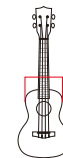

UPPER
BOUT
WIDTH
上桶宽
152 mm
6 in.



LOWER
BOUT
WIDTH
下桶宽
229 mm
9 in.

NET WEIGHT / 净重
0.94 KG / 2 LBS

NET WEIGHT / 净重
1.04 KG / 2.3 LBS

MULTI-ANGLE VIEW 多角度视图



PRODUCT HIGHLIGHTS 产品亮点



PADDED NECK CRADLE

The padded neck cradle is firmly in place and the headstock is fully protected against backward drops and side-to-side impacts.

琴颈保护枕

琴包内部配有一个厚实而且软硬适中的琴颈支撑垫，用于保护琴颈和琴头不受晃动或跌落带来的风险，而且它是可以根据不同琴颈的尺寸自由调节最佳的支撑位置。



WATER-PROOF MATERIAL

The waterproof coating on the surface and PVC coating on the opposite side effectively prevents the liquid from infiltrating into the case.

防水材料

琴包表面材料加入了防水涂层，面料的反面加有PVC涂层，可以有效防止液体渗入包中。



SHOULDER STRAPS

S-shaped shoulder straps with massage cushions are ergonomically designed to reduce the burden on the shoulders.

双肩背带

带按摩垫的S形双肩背带符合人体工程学设计，可减轻肩部负担。



INDUSTRIAL ZIPPERS

All Music Area zippers have passed the mechanical tests by zipping and unzipping over 8000 times

工业级拉链

所有音乐驿站产品的拉链都通过了八千次的拉合测试。



30MM PADDING
30MM内部填充物



WATER-PROOF
防泼水



TOP & BACK & SIDES
(from outer to inner layer)

1. 900D Polyester
2. Polyurethane Foam (5mm)
3. EPE (20mm)
4. Polyurethane Foam (5mm)
5. Polyester Velboa Fabric

正面和背面和侧面
(从表层到里层)

1. 聚酯纤维
2. PU软泡棉 (5mm)
3. 聚乙烯发泡棉 (20mm)
4. PU软泡棉 (5mm)
5. 毛绒布

SAXOPHONE CASES

萨克斯包



ALTO SAXOPHONE CASE
中音萨克斯包

RB30-ALTOSAX-BLK

TENOR SAXOPHONE CASE
高音萨克斯包

RB30-TENORSAX-BLK

MAX DIMENSION OF SUITABLE SAXOPHONE					
INTERIOR LENGTH 内长	INTERIOR WIDTH 内宽	INTERIOR HEIGHT 内高	INTERIOR LENGTH 内长	INTERIOR WIDTH 内宽	INTERIOR HEIGHT 内高
59.7 cm 23.5 in.	22.8 cm 9 in.	12 cm 4.75 in.	77 cm 30.35 in.	26 cm 10.25 in.	14 cm 5.15 in.
NET WEIGHT / 净重 1.6 KG / 3.5 LBS			NET WEIGHT / 净重 2.26 KG / 4.9 LBS		

MULTI-ANGLE VIEW 多角度视图



PRODUCT HIGHLIGHTS 产品亮点



PADDED AND
REINFORCED SIDEWALLS
加厚加固保护板



BACK HANDLE
背部垂直提手



SIDE HANDLE
侧面提手



SHOULDER STRAP
单肩背带



禁敲击

硬座车
YINGZUOCHE
YZ₂₂ 799

4-21+T²

RB30-V44-TBLK

VIOLIN CASE (4/4)

小提琴包 (4/4)



PADDED NECK CRADLE
琴颈支撑垫



BODY POUCH
琴体保护套



BRIDGE PROTECTION
琴桥保护



SAFETY ROOM FOR BOWS
安全独立的琴弓储存位

GUITAR STARPS

吉他背带

RB-STP-BLK 标准黑



Black, Standard

RB-STP-BLK-WL 加宽黑L



Black, Wide, Long

RB-STP-BLK-WS 加宽黑S



Black, Wide, Short

RB-STP-GRY 标准灰



Gray, Standard

RB-STP-GRY-WL 加宽灰L



Gray, Wide, Long

RB-STP-GRY-WS 加宽灰S



Gray, Wide, Short

MODEL 型号	PADDING LENGTH 肩垫长	MAX LENGTH 最大总长	MINIMAL LENGTH 最小总长	PADDING WIDTH 肩垫宽	SURFACE MATERIAL 面料	PADDING MATERIAL 填充材料	ENDS MATERIAL 皮头材料	PADDING THICKNESS 肩垫厚
RB-STP-BLK 标准黑	69.5 cm / 27.4 in.	138 cm / 54.3 in.	116 cm / 45.7 in.	7.5 cm / 3 in.	POLYESTER FABRIC 聚酯纤维	EPE 聚乙烯发泡棉	HIGH-ABRASION GREEN RUBBER 高耐磨环保橡胶	1.5 cm / 0.59 in.
RB-STP-BLK-WL 加宽黑L	61.5 cm / 24.2 in.	141 cm / 55.5 in.	113 cm / 44.5 in.	9 cm / 3.5 in.				
RB-STP-BLK-WS 加宽黑S	61.5 cm / 24.2 in.	119 cm / 46.9 in.	102 cm / 40.2 in.	9 cm / 3.5 in.				
RB-STP-GRY 标准灰	69.5 cm / 27.4 in.	138 cm / 54.3 in.	116 cm / 45.7 in.	7.5 cm / 3 in.	PU LEATHER PU皮革	EPE 聚乙烯发泡棉	HIGH-ABRASION GREEN RUBBER 高耐磨环保橡胶	1.5 cm / 0.59 in.
RB-STP-GRY-WL 加宽灰L	61.5 cm / 24.2 in.	141 cm / 55.5 in.	113 cm / 44.5 in.	9 cm / 3.5 in.				
RB-STP-GRY-WS 加宽灰S	61.5 cm / 24.2 in.	119 cm / 46.9 in.	102 cm / 40.2 in.	9 cm / 3.5 in.				

ISOTHERMIC BACKPACK

恒温双肩背包



The inner lining of the isothermic bag is made of high-quality aluminum foil, which is soft and smooth, super bright and highly reflective. It maintains the temperature of its contents up to 6 to 8 hours, keeping cold items cold, and hot items hot.



恒温包的里布采用的是一种具有隔热、恒温效果的铝箔材料，具有冬暖夏凉的特点，您可以存放效果器、话筒等设备，也可以用于存放啤酒、可乐等饮料。

FEATURE COMPARISON OF
GUITAR/BASS SERIES
吉他贝斯系列功能对比



SERIES	AA31	AA30	DRAGON 龙	WIND30 风30	HAN30 汉30
SURFACE MATERIAL	1680D POLYESTER 聚酯纤维	900D*400D POLYESTER 聚酯纤维	GILT CANVAS 镀金帆布	1680D POLYESTER 聚酯纤维	PVC LEATHER PVC皮革
WATER-PROOF	√	√	+RAIN COVER	√	√
PADDING THICKNESS	30MM	30MM	30MM	30MM	30MM
FRONT REINFORCEMENT	√	√	√		√
BACK REINFORCEMENT	√	√	√		√
SIDE REINFORCEMENT	√	√			
ZINC WALL HANGING HOOK	√	√	√	√	√
HIDEABLE STRAPS	√	√	√	√	√
STORAGE POCKETS	6	2	10	6	4
REMOVABLE NECK CRADLE	√	√	√	√	√
REMOVABLE STRAP-PIN BUMPER	√	√	√	√	√
REFLECTIVE STRIPES FOR SAFETY				√	
TWO INSTRUMENTS MODEL	√				
HARD-WEARING PVC SOLE	√	√	√	√	√
OPTIONAL COLORS	BLACK, GREY	BLACK	DARK GOLD	BLACK, DARK GREEN	BROWN, GREY
OPTIONAL INSTRUMENTS	EG, EB, 2EG, 2EB	DA, AC	EG, EB, DA	EG, EB, DA, AC	EG, EB, DA, AC

EG=ELECTRIC GUITAR / 电吉他
EB=ELECTRIC BASS / 电贝司

DA=ACOUSTIC GUITAR / 民谣吉他
CG=CLASSIC GUITAR / 古典吉他



TANG30 唐30	RB30 精英30	WIND20 风20	RB20 精英20	RB10 精英10	系列
900D POLYESTER 聚酯纤维	900D*400D POLYESTER 聚酯纤维	900D POLYESTER 聚酯纤维	900D POLYESTER 聚酯纤维	900D POLYESTER 聚酯纤维	面料
√	√	√	√	√	防水
30MM	30MM	30MM	20MM	10MM	厚度
	√				前幅加强板
	√				后幅加强板
					侧面加强板
√	√	√			顶部墙挂钩
√	√				可隐藏背带
6	5	3	1	1	附加口袋数
√	√	√	√		可拆卸琴颈保护枕
√	√				可拆卸尾钉保护垫
√			√		安全反光条设计
√					双琴包型号
√	√	√	√	√	耐磨PVC底垫
BLACK, GREY	BLACK	BLACK, DARK GREEN	BLACK	BLACK	可选颜色
EG, EB, DA, AC, 2AG	EG, EB, DA, AC	EG, EB, DA, AC, 34	EG, EB, DA, AC, 34	EG, DA	可选乐器

34=3/4 SIZED ACOUSTIC GUITAR / 3/4 36寸民谣吉他
2EG=2X ELECTRIC GUITARS / 2X 电吉他

2EB=2X ELECTRIC BASS / 2X 电贝司
1A1E=1X ACOUSTIC + 1X ELECTRIC GUITAR / 1X 民谣 + 1X 电吉他

Ruby Industrial Co., Ltd

东莞市乐邦实业有限公司

Address: Shuibei Industrial Zone, Shipai, Dongguan, Guangdong, China.

公司地址：中国广东东莞市石排镇凯联路水贝工业区

Tel/电话: +86-0769-81383618, 81383628 Ext:166

E-mail/邮箱: sales@musicarea.cn

Website/官网: www.musicarea.cn



音乐驿站新浪微博



音乐驿站微信公众号

   @MusicArea.cn

 YouTube MusicAreaCases

Copyright © 2008–2018 Ruby Industrial Co., Ltd. All Rights Reserved.

Any information is subject to change without notice.

东莞市乐邦实业有限公司保留所有权利。

如有细节变动，恕不另行通知。

