

R.A.M.

SYSTEM 2000

DESKTOP MONITORING SYSTEM
WITH BLUETOOTH
RAM SYSTEMS



USER MANUAL



INTRODUCTION

Thank you for choosing the **R.A.M. SYSTEM 2000**. Heritage Audio is dedicated to bringing you ‘the sound of yesterday for tomorrow’. We specialize in capturing that unique, enticing sound that everybody has fallen in love with. For years engineers, producers and musicians have been yearning for that classic vibe. Usually the only option is to search for old, used original equipment that is almost always in a questionable state of operation. This brings with it a whole lot of other issues, making the experience less than desirable. Not to mention the very high prices asked for this equipment, which makes them virtually unobtainable for the great majority. Now it’s possible to obtain that same sound with a brand new piece that will give you all the problem-free, heavy-duty use you’ll need for years of music making history.

Peter Rodriguez
CEO
Heritage Audio - Madrid, Spain



© 2022 Heritage Audio S.L. is the sole owner of the copyright of all information and drawings contained in this manual which are not to be copied or reproduced by any means or disclosed in part or whole to any third party without written permission.

Heritage Audio reserves the right to alter specifications without notice. The information in this manual has been carefully checked and is believed to be accurate at the time of publication. However, no responsibility is taken by us for inaccuracies, errors or omissions nor any liability assumed for any loss or damage resulting either directly or indirectly from use of the information contained within it.

TABLE OF CONTENTS

INTRODUCTION	2
CONTENTS	2
DESCRIPTION	3
GETTING STARTED	4
APPLICATIONS	6
SPECIFICATIONS	11
SIGNAL FLOW	11
TROUBLE SHOOTING	12
WARRANTY STATEMENT	13
REGISTRATION	13
RECALL SHEETS	14



DESCRIPTION

The Heritage Audio R.A.M. SYSTEM 2000 is a professional monitor controller in an attractive and convenient tabletop format. With its matrix of inputs and outputs the System 2000 will cover all the monitoring needs of the most demanding professional facilities at a price never heard of before.

The R.A.M. SYSTEM 2000 features generous I/O, with three pairs of +4 dBu balanced analog inputs and three stereo outputs, in addition to an independent pre-fader MIX OUT. Separate stereo CUE Inputs and Outputs, a 24Bit S/PDIF coax input, and pro-audio-quality Bluetooth input via antenna, for easy mobile device integration. For communicating with talent, there's a built-in Talkback with console-style management and routing. Lastly, Heritage Audio equipped the R.A.M. SYSTEM 2000 with an independent Subwoofer output that lets you effortlessly share your sub between different speaker pairs.

The R.A.M. SYSTEM 2000 is fitted with a 64-step, gold-plated relay ladder attenuation for master level control — a feature usually found only on high-end large-format consoles. It gives an exceptional resolution of 64 dB of attenuation in 1 dB steps. Keeping active electronics to a minimum, the attenuator is buffered using state of the art Burr Brown circuitry for negligible coloration and no noise. For easy recall of common settings, two user-assignable preset levels are also provided.

Headphone monitoring is as critical as main speaker monitoring. Usually a weak link even in the most expensive units, the R.A.M. SYSTEM 2000 employs very high current drivers in a diamond buffer configuration which are able to drive all headphones to very high levels without any coloration or noise. It has 2 headphone amplifiers that are individually configurable and adjustable.

Having classic RAF-gray cosmetics and a prominent red Marconi knob, your R.A.M. system will add a touch of class to your control room.



GETTING STARTED

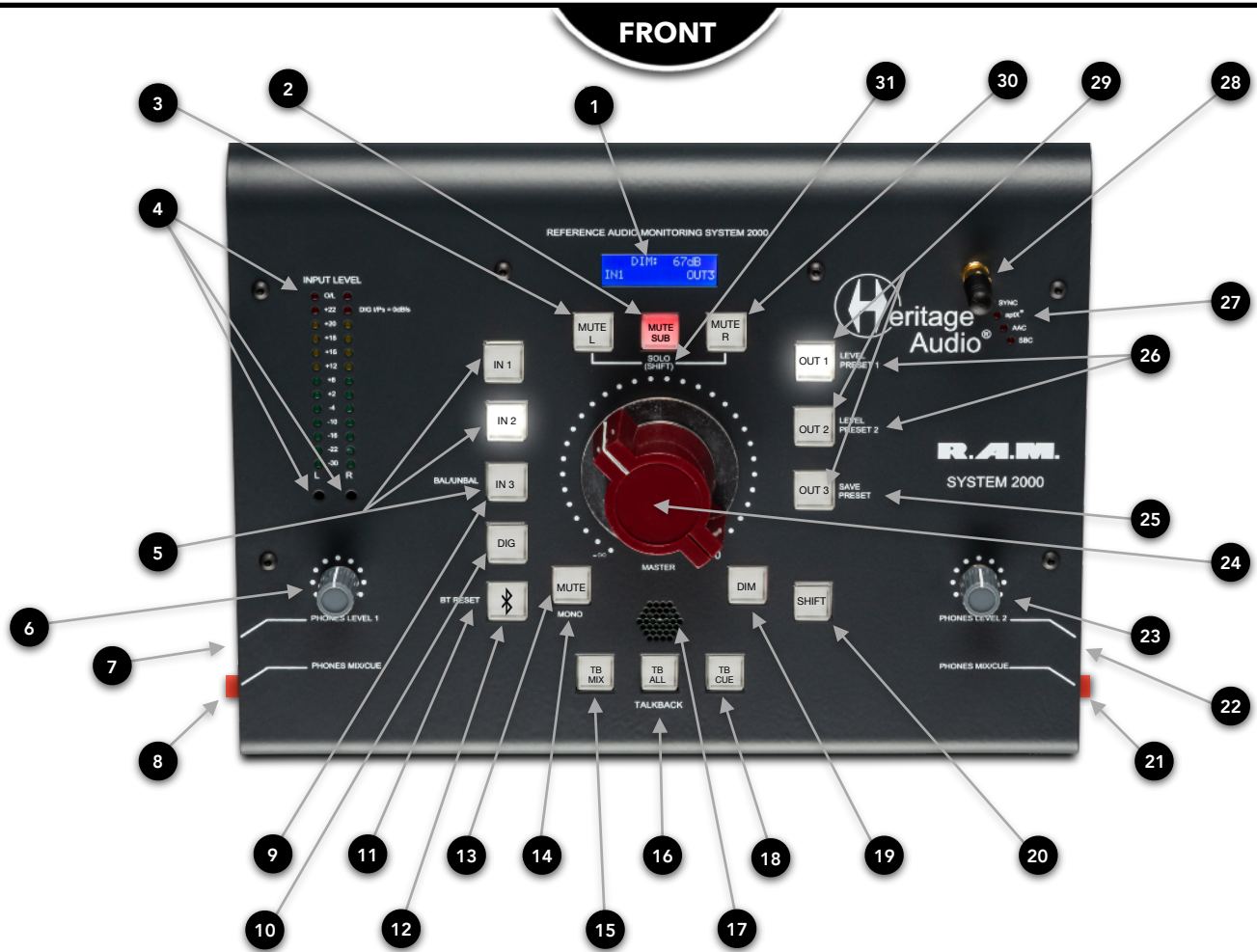

1	2	3	4	5
LCD SCREEN Updates to function being used indicating values	MUTE SUB Mutes the Subwoofer Output	MUTE L Mutes Left Channel	INPUT LEVEL LED Input Level Meter and with Calibration Screws *	INPUTS Selects between Analog 1-3
6	7	8	9	10
PHONES LEVEL 1 Headphone Volume adjustment	HEADPHONE 1 OUTPUT 1/4 TRS Jack	PHONES 1 MIX/CUE Selects monitor signal	BAL/UNBAL Switches Input 3 to -10 dBV Unbalanced	DIG Digital Input
11	12	13	14	15
BT RESET Resets the Bluetooth connection	 Bluetooth Input	MUTE Mutes the output	MONO Collapses the signal to mono	TB MIX Sends Talkback to MIX
16	17	18	19	20
TB ALL Sends Talkback to ALL	TB MICROPHONE Captures signal going to TalkBack	TB CUE Sends Talkback to CUE	DIM Reduces Output by -20 dB	SHIFT Engages the Soft Functions
21	22	23	24	25
PHONES 2 MIX/CUE Selects monitor signal	HEADPHONE 2 OUTPUT 1/4 TRS Jack	PHONES LEVEL 2 Headphone Volume adjustment	64 STEP ATTENUATOR 64-Step relay ladder attenuation with 1 dB steps	SAVE PRESET Saves Level Preset
26	27	28	29	30
LEVEL PRESETS Sets the Predefined Volume Level 1&2	LED CODEC INDICATOR Shows the CODEC in use and confirms connection	BLUETOOTH ANTENNA Bluetooth wireless input(AAC, APTX, SBC)	OUTPUTS Selects between Outputs 1-3	MUTE R Mutes Right Channel
31	*CALIBRATION The R.A.M. SYSTEM 2000 is properly calibrated from our headquarters, but it is possible to recalibrate if desired or necessary. To calibrate the Input LEDs we recommend sending it a tone, digitally, at around 16-18 db FS for adjustment. This is because in that area it will be more exact as there are only 2 dBs of range, therefore allowing you to focus more precisely. And if possible, do use the SPDIF digital input for this.			
SOLO (SHIFT) Selects SOLO For Left, Right or SUB				

REAR

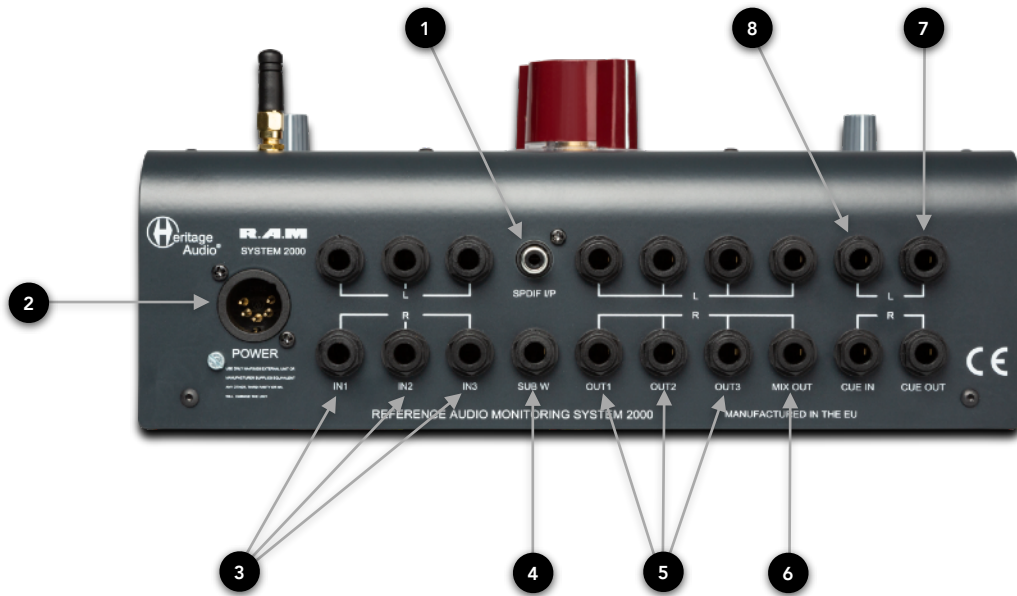

1	2	3	4	5
SPDIF I/P 24Bit/96 kHz Digital Input	POWER 5 Pin Power Connector	L/R INPUTS 1-3 Analog Inputs on TRS Jacks	SUB W Dedicated Subwoofer Output on TRS Jack	L/R OUTPUTS 1-3 Analog Outputs on TRS Jacks
6	7	8		
MIX OUT Stereo Mix Output	CUE OUT L/R Outputs	CUE IN L/R Inputs		

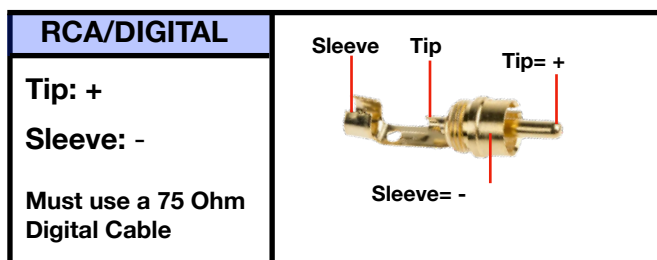
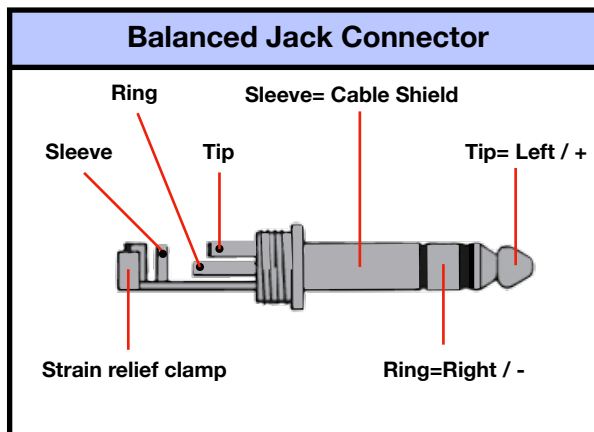

APPLICATIONS

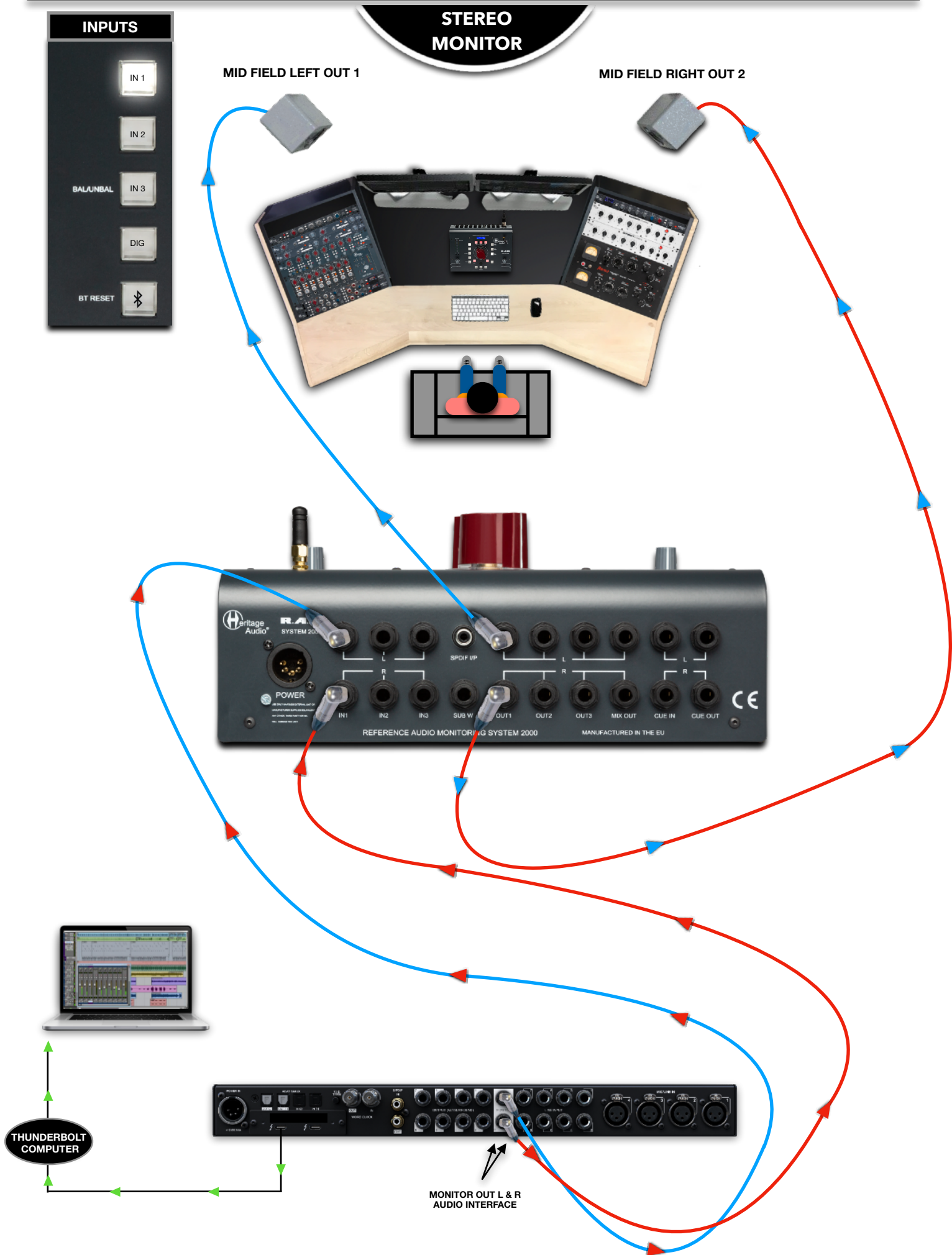

INPUTS

IN 1

IN 2

BALUNBAL IN 3

DIG

BT RESET 

BLUETOOTH STEREO MONITOR

MID FIELD LEFT OUT 1

MID FIELD RIGHT OUT 2

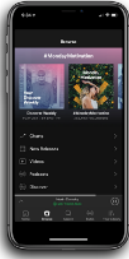

Heritage Audio SYSTEM 2000

POWER

IN1 IN2 IN3 SUB W OUT1 OUT2 OUT3 MIX OUT CUE IN CUE OUT

REFERENCE AUDIO MONITORING SYSTEM 2000 MANUFACTURED IN THE EU



THUNDERBOLT COMPUTER

MONITOR OUT L & R AUDIO INTERFACE

MONITOR OUT L & R AUDIO INTERFACE

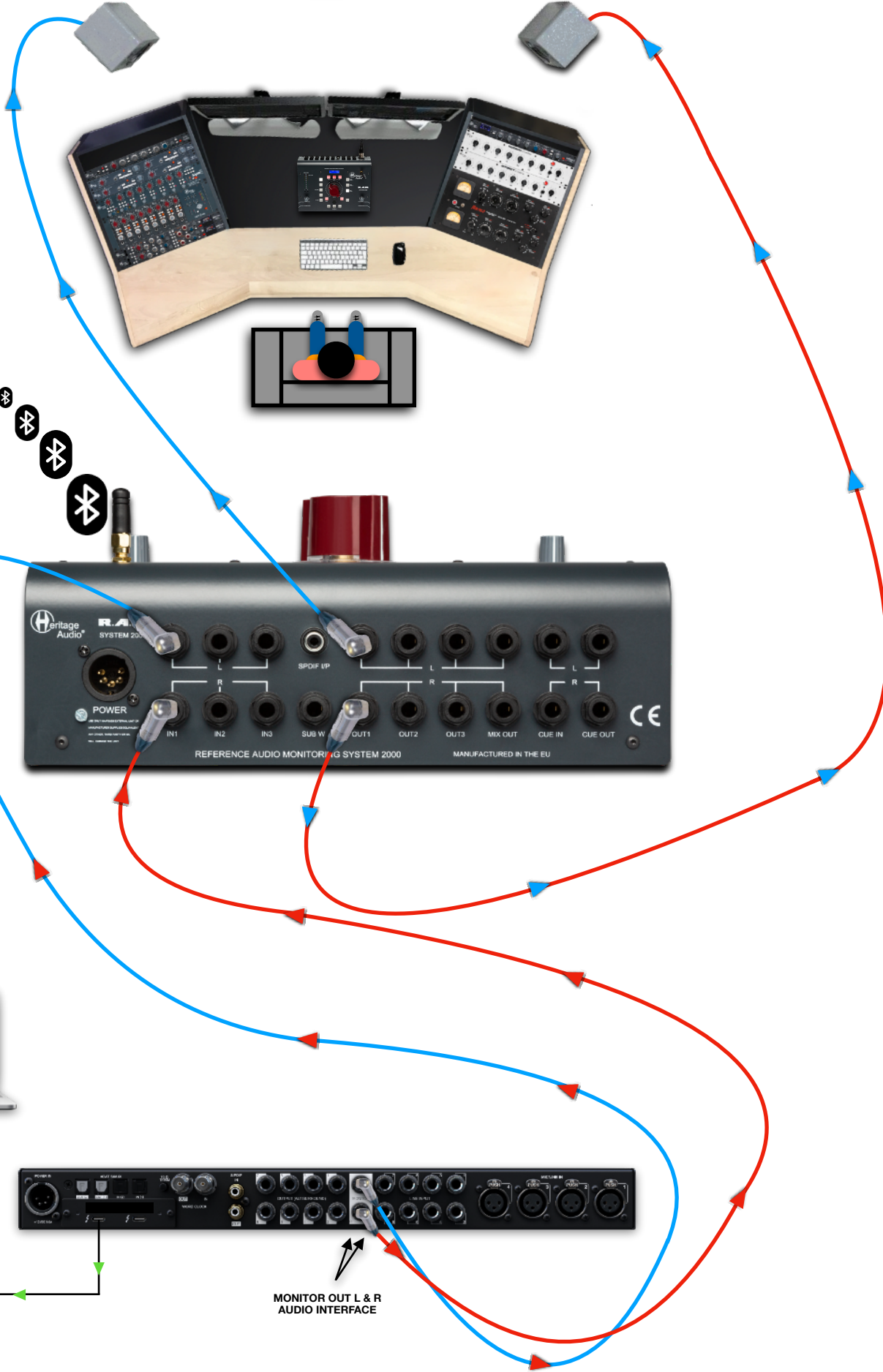

INPUTS

IN 1

IN 2

BALUNBAL IN 3

DIG

BT RESET

DIGITAL STEREO MONITOR

MID FIELD LEFT OUT 1

MID FIELD RIGHT OUT 2



Heritage Audio SYSTEM 2000

POWER

IN1 IN2 IN3 SUB W

SPDIF I/P

OUT1 OUT2 OUT3 MIX OUT CUE IN CUE OUT

REFERENCE AUDIO MONITORING SYSTEM 2000

MANUFACTURED IN THE EU



THUNDERBOLT COMPUTER

DIGITAL SPDIF OUT

MONITOR OUT L & R AUDIO INTERFACE

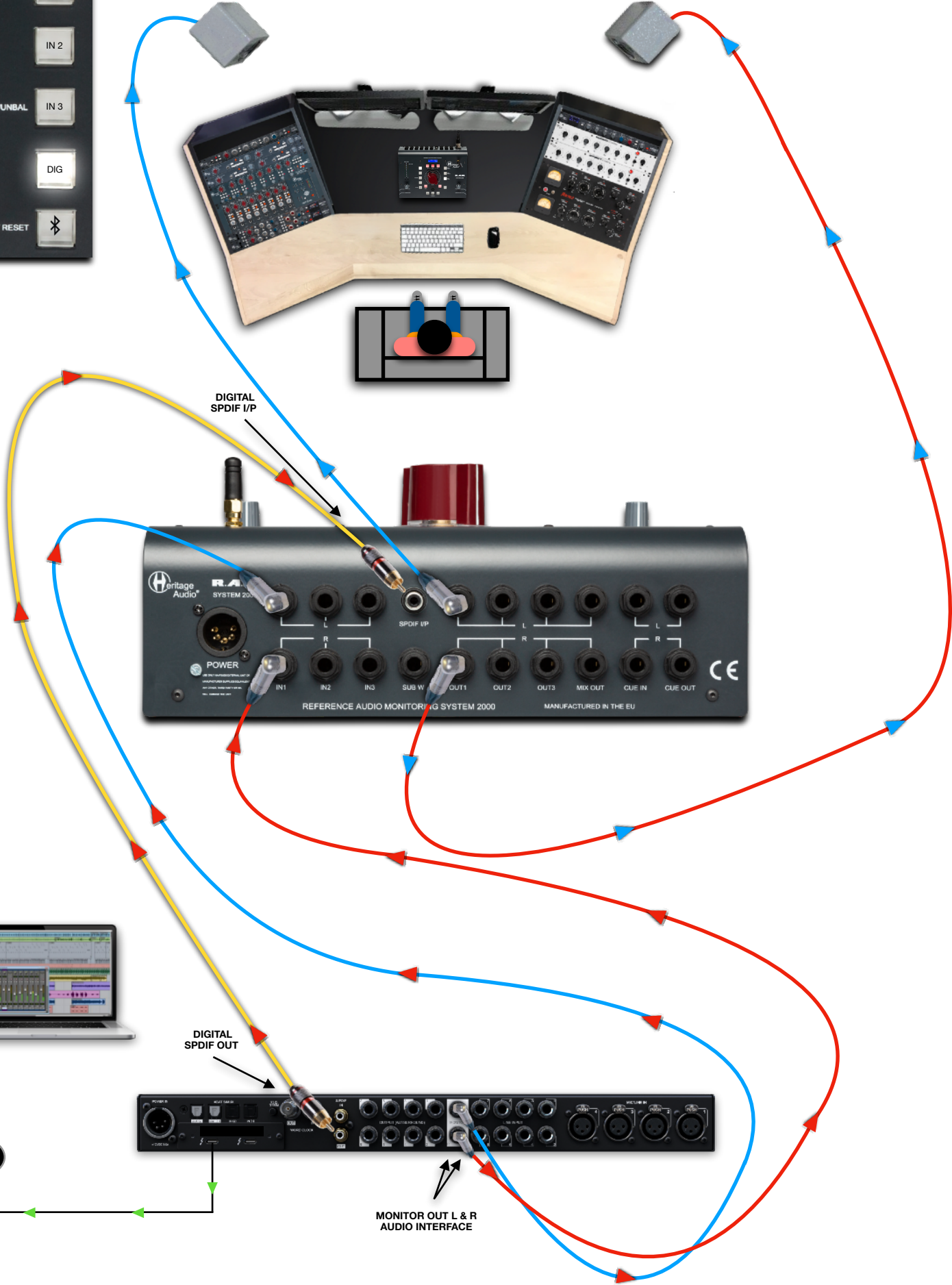



THREE OUT MONITORING WITH CUE

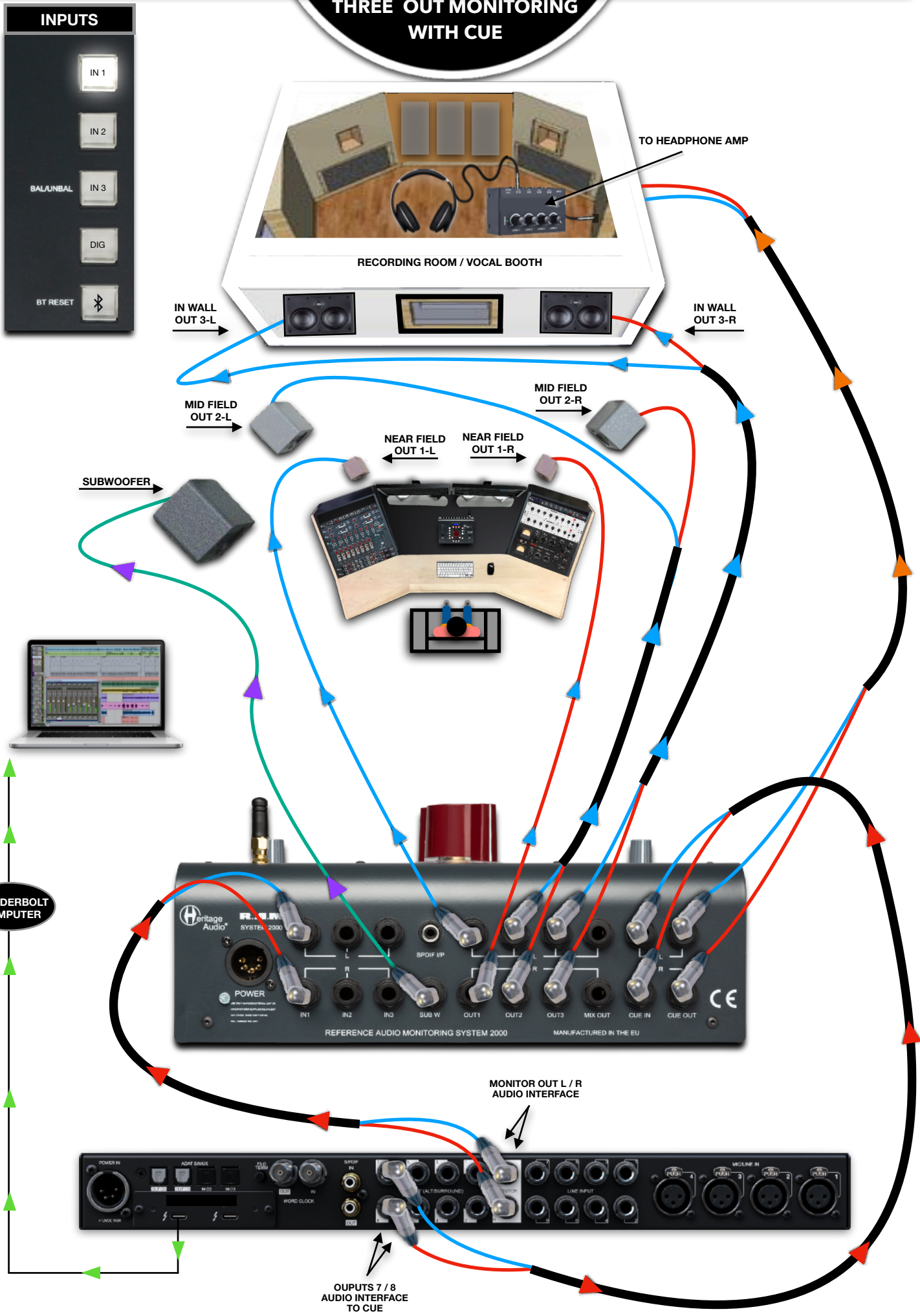

SPECIFICATIONS



- **Maximum analog input level:** Over +27,5 dBu.
- **Digital input:** Up to 24Bit/96 kHz. 0 dBfs= +22 dBu at the output, fader fully up.
- **Bluetooth input:** AAC, aptX or SBC, 0 dBfs= +22 dBu at the output, fader fully up.
- **DIM attenuation:** -20 db.
- **Maximum output level:** Over +27 dBu into 600 Ω.
- **Noise:** Better than -99 dBu.
- **THD:** Better than .001 % at 1 kHz, balanced input to balanced output, fader fully up.

Dimensions/Weight

- **Dimensions (W x H x L):** 213 mm x 85 mm (With antenna: 115 mm) x 266 mm.
- **Weight:** 2,435 Kg.

SIGNAL FLOW

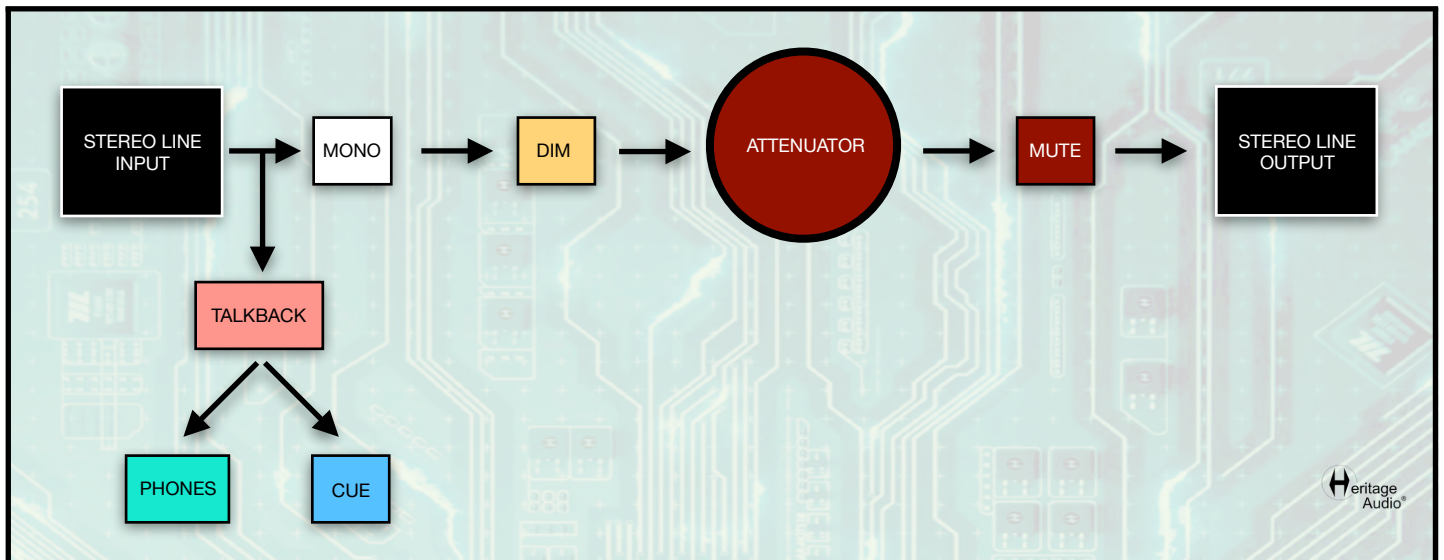

TROUBLE SHOOTING



PROBLEMS	SOLUTIONS
There is no sound coming from my R.A.M. SYSTEM 2000.	Make sure the 'MUTE' button is not pressed.
The audio from my R.A.M. SYSTEM 2000 seems less open than the audio directly from my DAW.	Double check that you have not accidentally pressed the 'MONO' button.
Even with the volume knob all the way up it doesn't seem to output as much as before.	You may have the 'DIM' button pushed, reducing the output by -20dB.
There is no signal present at the R.A.M. SYSTEM 2000's Output.	Verify that you have correctly connected the Input and Output cables.
Upon turning on the R.A.M. SYSTEM 2000 there is no sound.	This is normal as it starts in MUTE. Just turn the volume knob to activate.
Is it possible to have both outputs or both inputs active at the same time?	No, you can only use one Input and one Output at any given time.
Can I use a stereo subwoofer?	No, there is only one subwoofer output. Subwoofer use is generally in MONO, not Stereo.
I want to use a new mobile device with the Bluetooth Input but it is not recognised.	Push the BT RESET button after connecting a new Bluetooth mobile device.

* For any further doubts or questions please get in contact with us at: support@heritageaudio.com

WARRANTY STATEMENT

LIMITED 2 YEAR WARRANTY

Heritage Audio **R.A.M. SYSTEM 2000** is warranted by Heritage Audio SL to be free from defects in materials and workmanship for the period of 2 years to the original purchaser. In the event of such defects, the product will be repaired without charge or, at our option, replaced with a new one if delivered to Heritage Audio prepaid, together with a copy of the sales slip or other proof of purchase date. The warranty excludes problems due to normal wear, abuse, shipping damage or failure to use the product in accordance with the specifications.

Heritage Audio shall not be liable for damages based upon inconvenience, loss of use of the product, loss of time, interrupted operation or commercial loss or any other damages, whether incidental, consequential or otherwise.

This warranty is not transferable.

Heritage Audio and the Heritage Audio “H” logos are registered Trademarks owned and/or licensed by Heritage Audio.



REGISTRATION

Please visit our website: <https://heritageaudio.com/registration/>

RECALL SHEETS

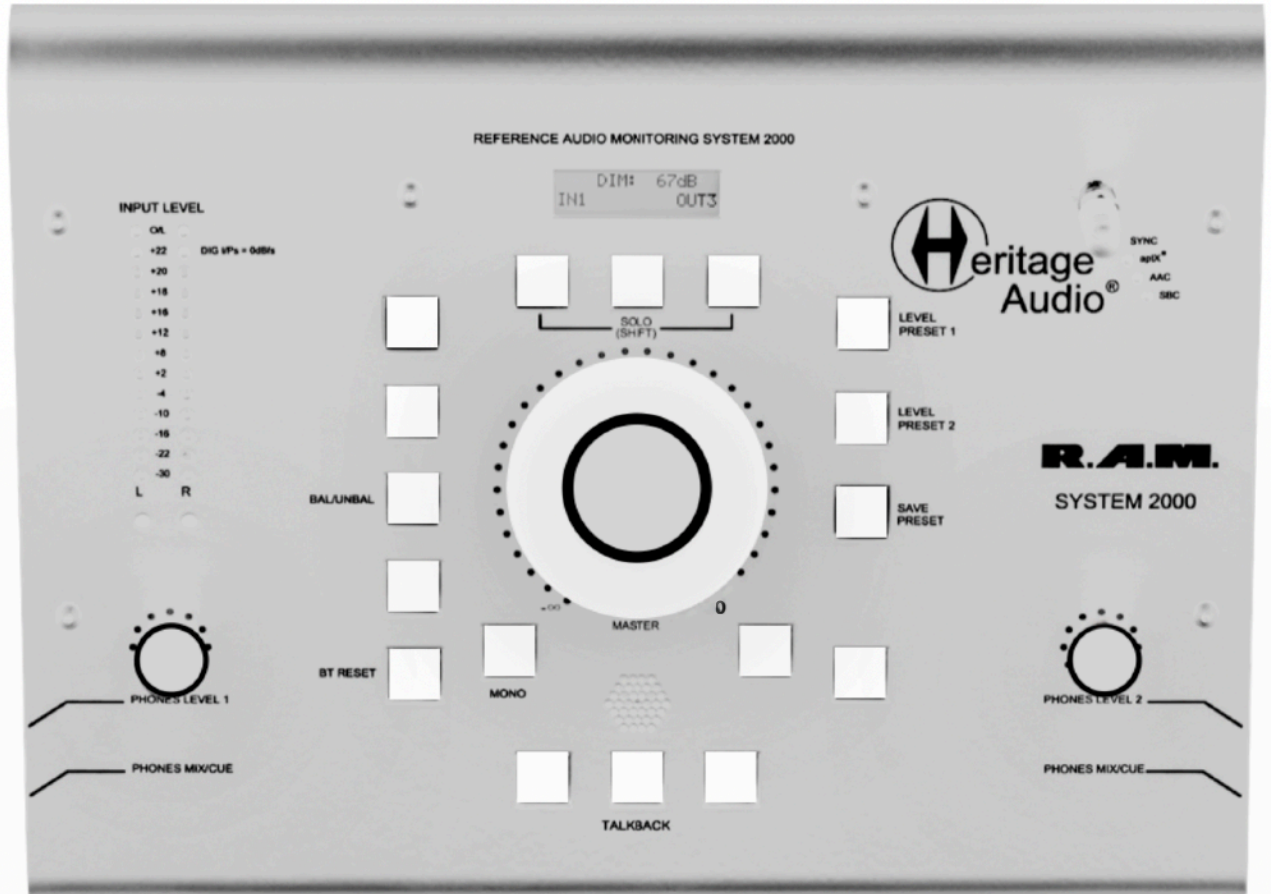

Session / Title: _____ Track: _____ CUE: _____ Codec: _____

Date: _____ Instrument: _____ Notes: _____

Switch ON

Switch OFF



www.heritageaudio.com

HERITAGE AUDIO. C/ Alfonso Gómez, 38, 3C. 28037 Madrid – Spain. Tel: +34 917 266 189

info@heritageaudio.com

