

iD24

10in | 14out
Audio Interface

Manual

AUDIANT

Welcome to your new Audient iD24 Audio Interface

To help get you started please visit audient.com/products/iD24 to download the latest software and firmware.

Inside the box:

- iD24
- USB Type C Cable
- Quick Start Guide



Features include:

- 2 x Class-A Audient Console Mic Preamps
- Class Leading AD/DA Converters
- 1 x Discrete JFET Instrument Input
- Main and Alt Speaker Outputs
- 1 x Independent Dual Headphone Output
- 1 x ADAT Input & Output
- 2 x Fully Balanced Inserts
- Ultra-low Latency DSP Mixer
- Audio Loop-back
- ScrollControl
- 3 x User Defined Function Keys
- Dedicated Dim and Cut Controls
- +48V, Pad, and HPF Switches
- USB 3.0 Compliant
- 24bit/96kHz
- Word Clock Output
- All-Metal Design
- Free Software + Plugins

Contents

iD24 Overview	4	Software Features:	26
Safety Information	5	Input Channel Types	27
Declaration of Conformities	7	Channel Features	28
Installation:	8	Mastering Section Features	30
Mac Installation	9	System Panel Features	33
Windows Installation	12	The Routing Matrix	35
iD App & Firmware Update	14	Setting Up Talkback	36
Hardware Features:	15	Save & Loading Presets	37
Microphone & Line Input	16	Audio Loop-back	38
Instrument Input	17	Using the Loop-back Mixer	39
Phantom Power Switch	17	Adjusting Output Channels	40
-10db Pad	17	Menu & Task Bar Icon	41
High Pass Filter	18	Firmware Update	42
Balanced Inserts	18	Keyboard Shortcuts	43
Insert Normalling	18	DAW Setups:	44
Patching Inserts	18	Pro Tools Setup	45
Direct Access to ADC	19	Logic Pro Setup	46
Digital Inputs and Outputs	21	Cubase/Nuendo Setup	48
Word Clock Output	21	Ableton Setup	50
Speaker Outputs	23	Troubleshooting & FAQ	51
Headphone Outputs	23	Technical Specifications	54
iD Button	24	Dimensions	55
Monitor Controls	24	Warranty	56
F-Keys	24	Service & Contact	57
Hardware Metering	25	Glossary	58
Status LED	25		
Kensington Lock	25		

iD24 Overview

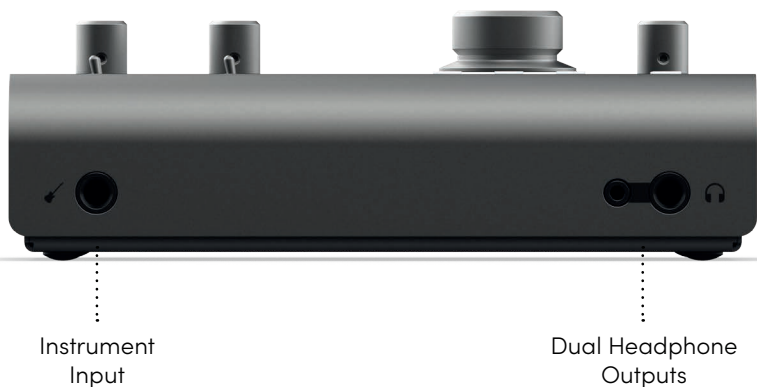
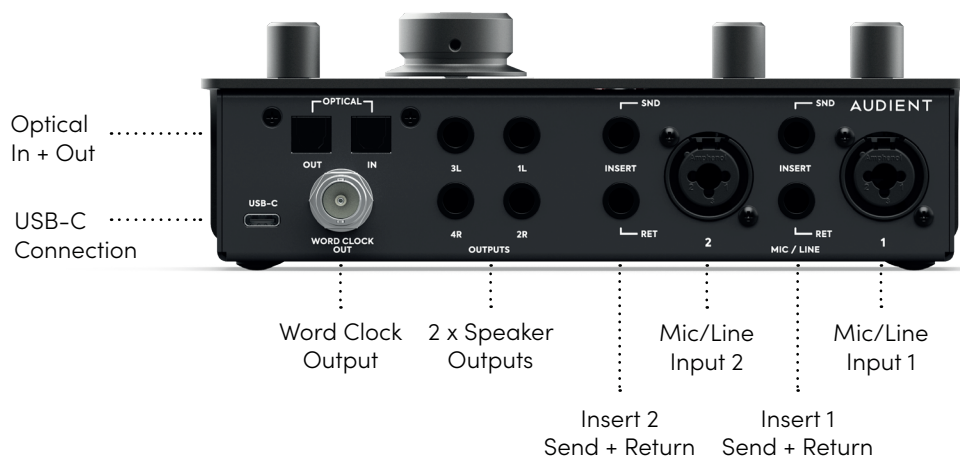
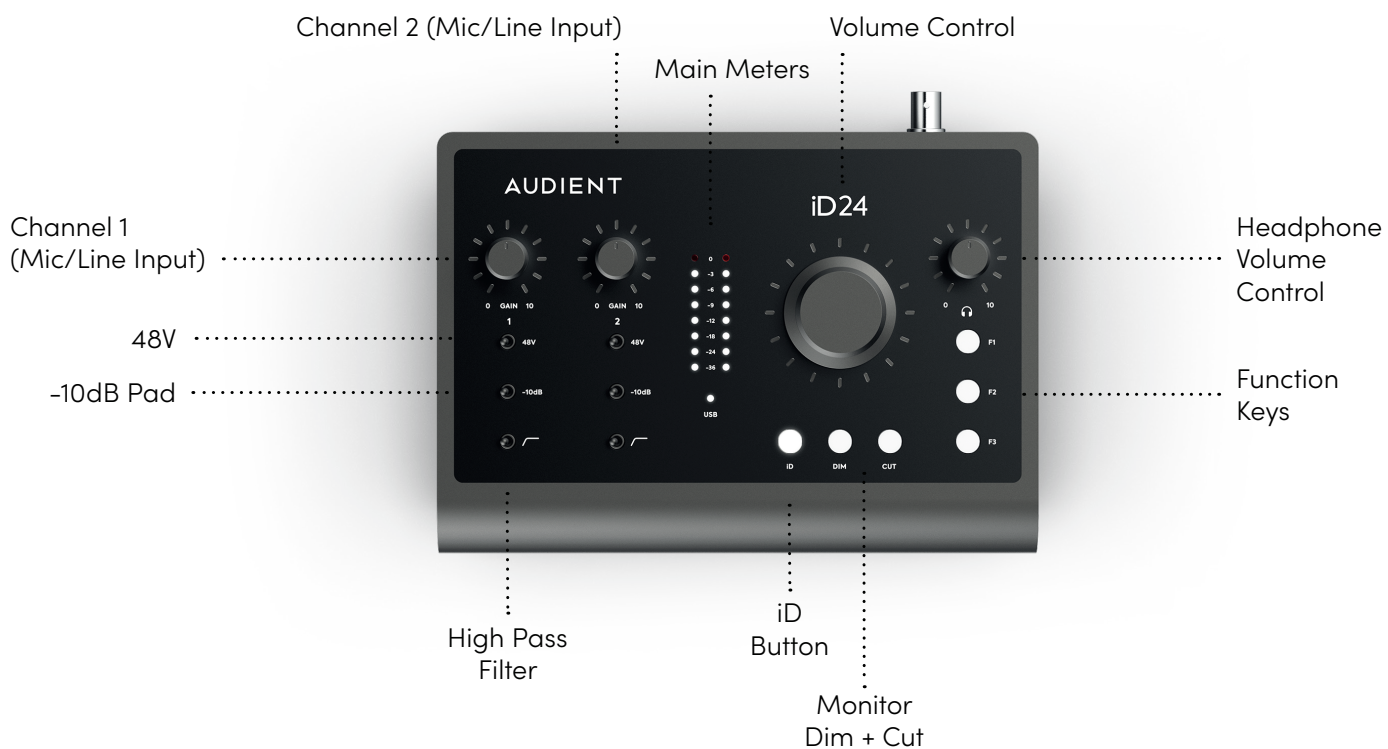

Safety Information

Important Safety Instructions

Please read all of these instructions and save them for later reference before connecting and powering up iD24.

The iD24 itself does not operate with any high voltage mains supply inside the unit but appropriate safety measures should still be adhered to regarding the USB supply.

Consult a qualified technician if you suspect difficulties. Do not attempt to tamper with the power supply or mains voltages - **HAZARDOUS TO HEALTH**. To reduce risk of fire or electrical shock, **DO NOT** expose this apparatus to rain or moisture.

WARNING!

No user serviceable parts inside.
Please refer servicing to qualified service personnel. You can find more information at support.audient.com

Safety Information

Important Safety Instructions

1. Read these instructions
2. Keep these instructions
3. Heed all warnings
4. Follow all instructions
5. Do not use this equipment near water
6. Clean only with dry cloth
7. Do not install near any heat sources such as radiators, heat registers, stoves, or other equipment (including amplifiers) that produce heat
8. Only use attachments/accessories specified by the manufacturer
9. Unplug this equipment during lightning storms or when unused for long periods of time
10. Refer all servicing to qualified service personnel. Servicing is required when the equipment has been damaged in any way, such as power supply cord or plug is damaged, liquid has been spilled or objects have fallen into the equipment, the equipment has been exposed to rain or moisture, does not operate normally, or has been dropped
11. For products that are a mains powered device: The equipment shall not be exposed to dripping or splashing and no objects filled with liquids (such as vases) shall be placed on the equipment

Declaration of Conformities

FCC Part 15B

This apparatus has been tested and found to comply with the limits of a class-A digital device, pursuant to Part 15B of the FCC Rules. These limits are designed to provide reasonable protection against harmful interference in a residential installation. This equipment generates, uses and can radiate radio frequency energy and, if not installed and used in accordance with the instructions, may cause harmful interference to radio communications. If this equipment does cause harmful interference to radio or television reception, which can be determined by turning the equipment off and on, the user is encouraged to try to correct the interference by one or more of the following measures:

1. Re-orient or relocate the receiving antenna
2. Increase the separation between the equipment and receiver
3. Connect the equipment into an outlet on a different circuit from that to which the receiver is connected
4. Consult the dealer or an experienced radio/TV technician for help



We, Audient Ltd, Aspect House, Herriard, Hampshire, RG25 2PN, UK, 01256 381944, declare under our sole responsibility that the product iD24 complies with Part 15 of FCC Rules.

Operation is subject to the following two conditions:

1. This device may not cause harmful interference,
2. This device must accept any interference received, including interference that may cause undesired operation



We, Audient Ltd, declare that the product, the iD24, to which this declaration relates, is in material conformity with the appropriate CE standards and directives for an audio product designed for consumer use.



We, Audient Ltd, declare that the product, the iD24, to which this declaration relates, is in material conformity with the appropriate UKCA standards and directives for an audio product designed for consumer use.



Audient Ltd has conformed where applicable, to the European Union's Directive EN 63000:2018 on Restrictions of Hazardous Substances (RoHS) as well as the following sections of California law which refer to RoHS, namely sections 25214.10, 25214.10.2, and 58012, Health and Safety Code; Section 42475.2, Public Resources

Installation

Mac Installation

System Requirements

macOS 10.11.6 (El Capitan) or Later
Mac Intel CPU or Apple Silicon
1GB RAM Minimum

1. Download the latest iD Software

Head to our website for the latest version of our iD Mixer:

audient.com/products/downloads/id24

Drag the downloaded app into your application folder to install it.

2. Connect iD24

Using the USB cable provided, connect iD24 to your computer's USB port.



USB - C

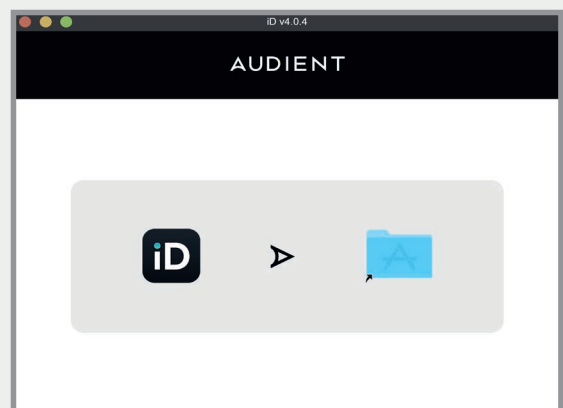

Mac Installation

3. Status LED

Once connected to your computer and powered on, the white status LED on iD24 will illuminate.

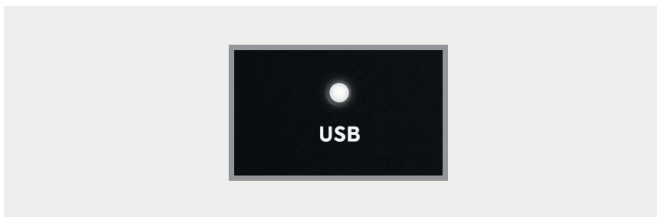

If at any time the status LED turns off during normal operation please check all connections and if further problems develop please contact Audient support.

4. Double Checking Connectivity

To ensure iD24 has been detected by your computer and correct clocking sources are set-up, navigate to:

Macintosh HD > Applications > System Preferences

Check that iD24 is set as your audio device. It's recommended to disable system sounds.

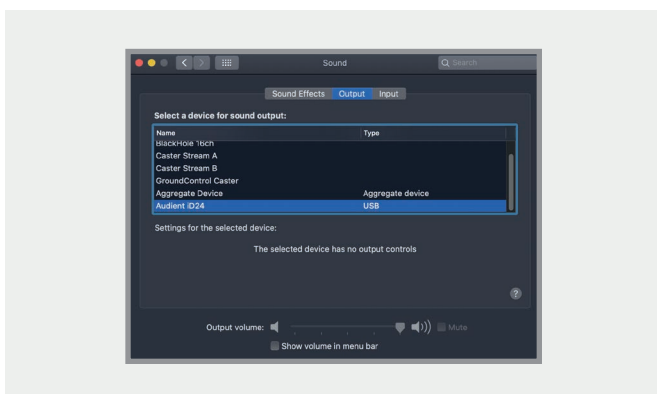

It's also worth checking Audio MIDI Setup (found in **Mac HD > Applications > Utilities**).

Window > Show Audio Window

Here you should see iD24 report with 10 inputs and 14 outputs. The clock source is configured in the iD app. See **page 24** for more details.

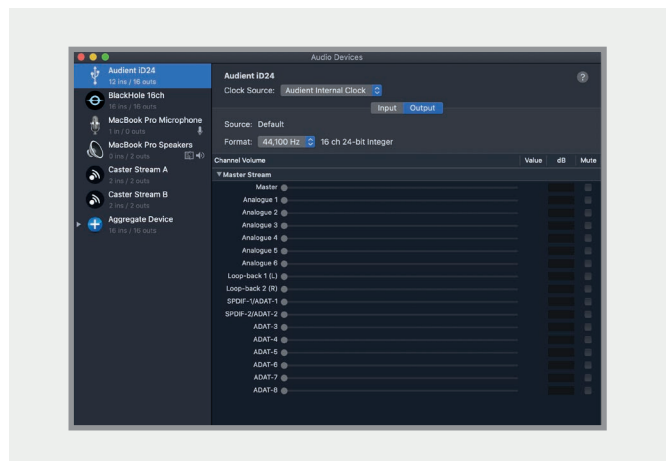

5. Open the iD Mixer

Run the iD Software. It will appear as an icon in the Menu bar of MacOS. Click on this and select '**Open Mixer Software**'.

Mac Installation

Menu/Task Bar Icons

On MacOS, the iD icon appears in the menu bar in the top right hand corner of the screen. This gives you quick access to various functions of the iD24.

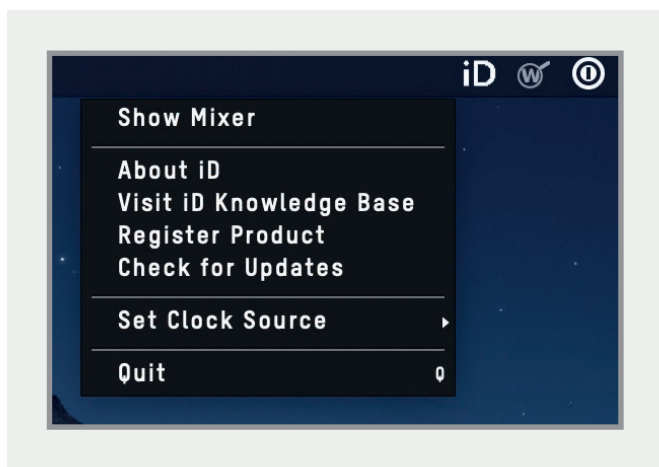

Show Mixer

If the mixer window has been hidden, this will bring it back to the forefront.

Quit

Fully closes the iD Software Mixer application.

About iD

Displays information regarding the current version of the iD Software Mixer application and firmware.

Visit iD Knowledge Base

Opens a browser windows for the Audient Helpdesk with helpful articles and FAQs.

Check for Updates

The iD app will check with the Audient update server for any available firmware updates for iD24.

Top Tip

Right click on the iD icon in the Dock and select Keep in Dock to have quick access to the iD mixer app at all times.

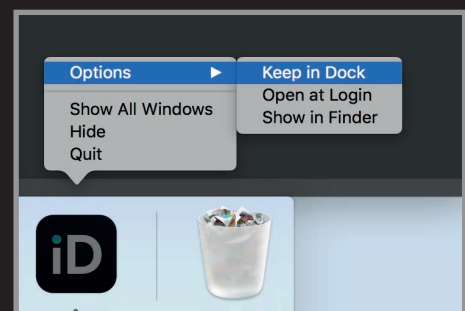

Windows Installation

Windows System Requirements:

Windows 10 or later (32 or 64 bit)

Intel Core 2 @1.6Ghz, or AMD equivalent

1GB RAM Minimum

1. Download the iD24 Software

Head to our website for the latest version of our iD Windows Installer:

audient.com/products/downloads/iD24

2. Connect iD24

Using the USB cable provided, connect iD24 to your computer's USB port.

3. Run iD Mixer Setup

Double click on the installer to run the iD mixer setup and follow the on-screen instructions.

4. Reboot PC

Reboot your PC to make sure that all the drivers have been installed.

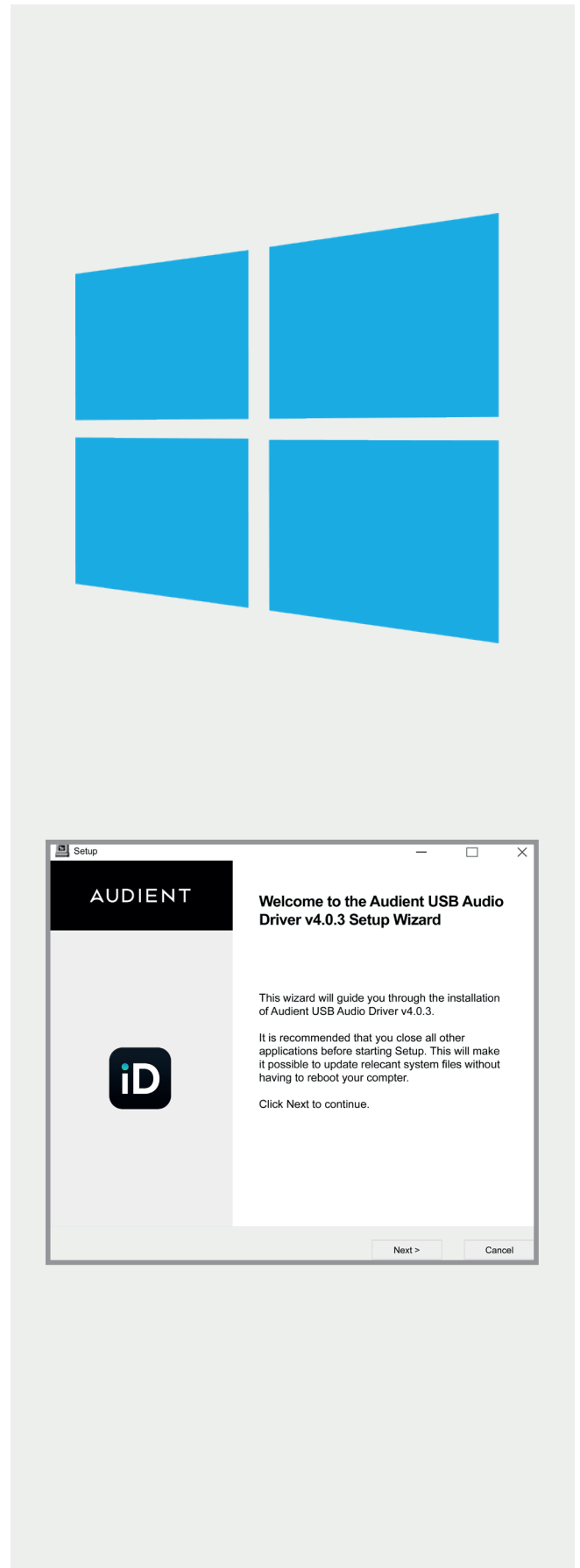

4. Check Connectivity

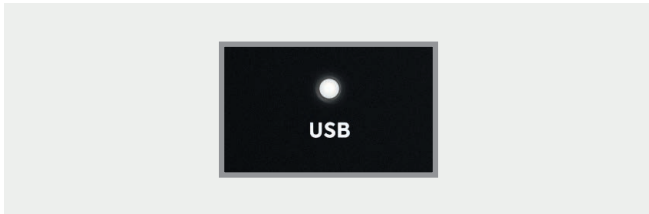

The USB status LED will illuminate as soon as iD24 has achieved stable communication and should remain solidly lit during operation of the unit until power down.

To double check the connection, go to PC sound settings by following:

PC Settings > Control Panel > Hardware and Sound > Sound

Here you can make it the computer's default sound device by selecting the unit and clicking "Set Default Device" on both the Playback and Recording Tabs.

iD Icon

Once installed, the iD icon can be found in the Windows system tray (it may be in the hidden icons area):

- Double-click to open the iD24 mixer window when iD24 is connected.
- Right-click to quit or change sample rate and buffer size.

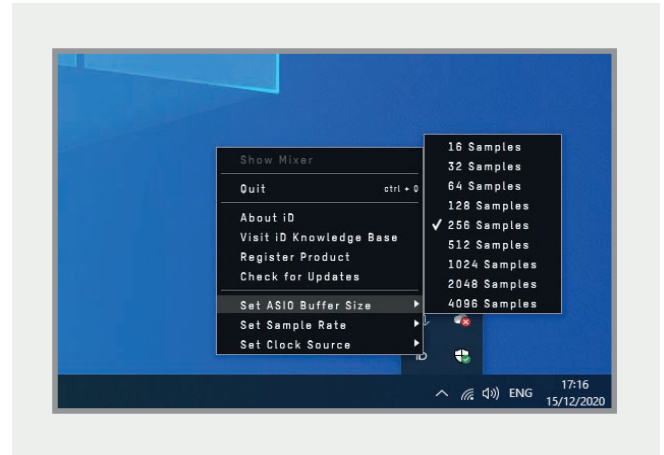

For mixing, a buffer size of 256 should be perfect. For tracking, experiment with lower buffer size values.

Various factors including how powerful your computer is, and how processor hungry your project is, will affect how low you can get the buffer size settings before you get audio instability.

More information on optimisation can be found on our support site.

iD App & Firmware Update

Launch the iD Mixer Application

Launch the iD24 Software Mixer application by finding it in the following folder:

Mac OS

Macintosh HD > Applications > iD

Windows

Start > All Programs > Audient > iD

On macOS, the iD app will launch into the Menu bar, in the top right corner of the screen. Click on the small iD icon to access the features of the application.

On Windows, the iD app will launch into the system tray, typically in the bottom right corner of the screen. Right click on the iD icon to access the features of the application.

For more information on the mixer application feature set, please refer to **page 28** onwards of this manual.



Check for Firmware Updates

If your computer is connected to the internet, the iD app will check for firmware updates whenever a unit is connected. If there is a firmware update available then the iD app will notify you.

You can manually check for updates by going to the Help menu and selecting '**Check for Updates**'. It will notify you if you're on the latest version of firmware or if you need to update.

Registration With Audient ARC

When you first open the iD Software Mixer a window will open asking you to register your unit to Audient ARC. Simply follow the instructions on-screen to create an account and register your unit.

This will give you access to free innovative software and services; meaning you'll have everything you need to get recording straight away.

If you plan on registering the product at a later time, then you can simply close the registration window. You'll see the window again the next time you use the unit.

Hardware Features

Microphone Preamplifiers & Line Inputs

iD24 features two classic Audient Console microphone preamplifiers. These preamps are based on designs from Audient's classic consoles and are the same that are used across our entire 'iD interface range'.

The design features discrete Class-A circuitry providing exceedingly low distortion and noise performance. From a sonic point of view, iD24 is fast, open and detailed.

Amphenol™ XLR/TRS Jack combi-connectors provide microphone and line inputs. The line inputs are padded by -10dB before passing through the microphone preamplifiers to minimise clipping on line-level signals.

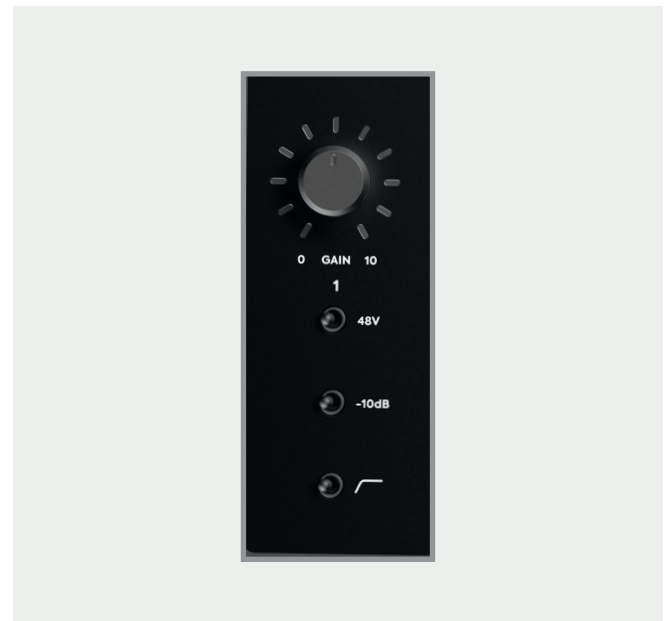

The microphone preamplifiers feature:

- 58 dB of clean gain
- >2.8kΩ input impedance which provides a punchy tone from any microphone transducer type



Instrument Input

iD24 employs a discrete class-a JFET instrument (D.I) input on channel one which is easily accessible on the front of the unit.

The JFET circuitry adds a tiny bit of colour and harmonics to the signal, making it sound great on guitars and basses.

Plugging in a TS (tip-sleeve unbalanced) jack will override the mic signal and turn channel one into a fully-fledged, fantastic-sounding instrument input.



Phantom Power Switch

There is an independent phantom power switch for each microphone channel. This provides full phantom power (48V \pm 4v, 10mA per channel) to the microphone connected to this channel.

Please note that the iD24 will only send phantom power to XLR connections, the TRS line inputs will not receive phantom power.

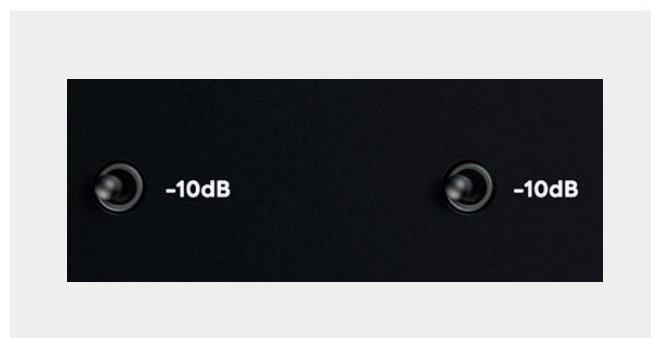

-10dB Pad

Both inputs feature a switchable hardware -10dB pad to help lower signal level when recording particularly hot sources such as drums.



High Pass Filter

Each pre-amp also includes a switchable hardware high pass filter that will remove frequencies below roughly 80Hz. This is good for removing rumble and room noise from your recordings.

Balanced Inserts & Returns

On both input channels, the iD24 features a dedicated insert allowing you to connect outboard gear to your recording chain; just like the workflow you would find on an Audient console!

The two channels feature an electronically balanced send and an electronically balanced return, all before the analogue to digital (AD) converters.

Insert your favourite hardware EQ and compressor into the insert and with the super clean Audient preamps you can build vocal chains that will rival the best out there!

Insert Normalising

The Insert send and return jacks are half-normalised meaning you don't need to patch the two together when not in use. The internal signal chain is only broken when a jack is plugged into the return.

Plugging a jack into the Insert send will split the signal which can be useful for parallel processing.

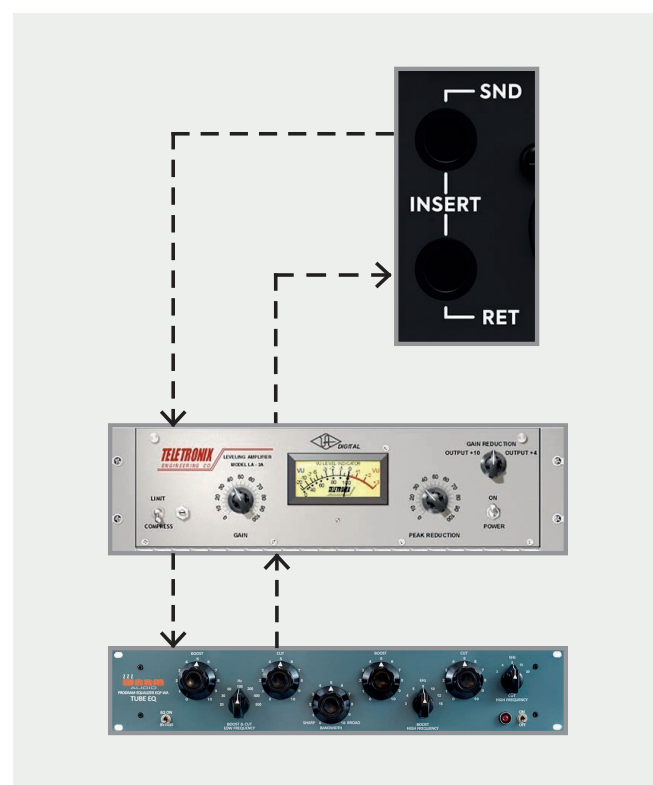

Patching Inserts

To incorporate your favourite processing before conversion, simply patch the iD24 Insert send into the first piece of gear in your processing chain. Then take the output of the last device in the chain and patch this into the iD24 Insert return.



Direct Access to ADC

The Insert return connection on the iD24 is an electronically balanced input stage that directly drives the analogue to digital converter (ADC) for that channel. As such, this is a great place to input signals directly to the ADC, bypassing the internal Audient preamplifiers and minimising any colouration of the signal.

This makes it useful to patch in external microphone preamplifiers without adding additional colouration or noise. It is also handy for using the iD24's outputs to drive external effects before returning them into your DAW using the insert returns.

Please note; the digital calibration level of the iD24's converters is 0dBFS = +12.5dBu.

Hardware Features

Class A Mic Preamplifier, Inserts, A/D converters and Optical Input Block Diagram

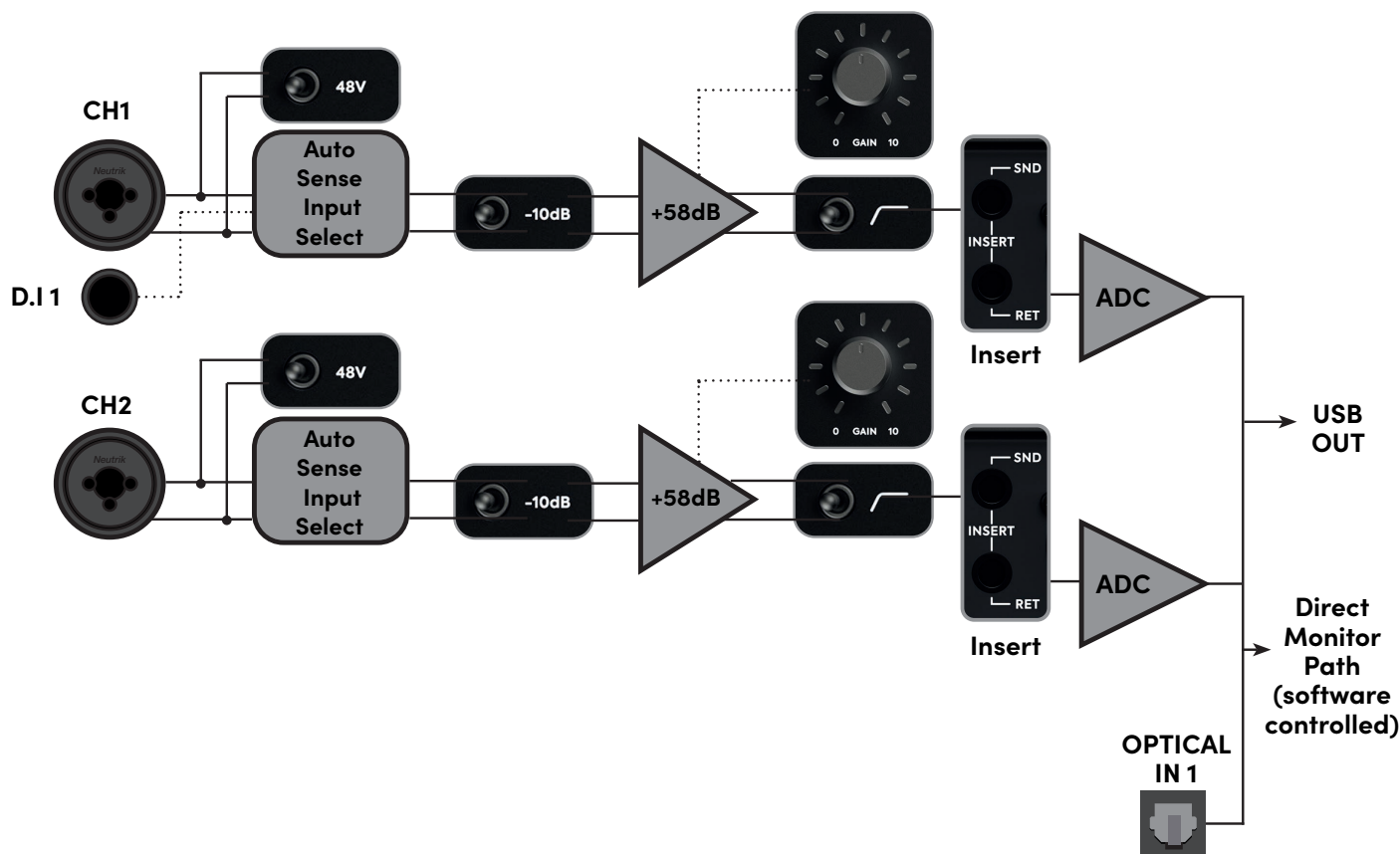

Input Specs

Microphone Input

XLR Combi Female
 Pin 1: Chassis Ground Pin
 Pin 2: Hot (+ve)
 Pin 3: Cold (-ve)
 Input Impedance: >2.8k ohm
 Maximum Input Level: +12dBu

Line Input

1/4" TRS Combi Jack
 Tip: Hot (+ve)
 Ring: Cold (-ve)
 Sleeve: Chassis Ground
 Input Impedance: >8k ohm
 Maximum Input Level: +22dBu

DI Input

1/4" TS Jack
 Tip: Hot (+ve)
 Sleeve: Ground
 Input Impedance: >500K Ohms

Insert Sends

1/4" TRS Jack
 Tip: Hot (+ve)
 Ring: Cold (-ve)
 Sleeve: Chassis Ground
 Output Impedance: >100 ohm
 Maximum Output Level: +22dBu

Insert Return

1/4" TRS Jack
 Tip: Hot (+ve)
 Ring: Cold (-ve)
 Sleeve: Chassis Ground
 Input Impedance: >10k ohm
 Maximum Input Level: +12.5dBu
 Digital Reference: 0dBFS = +12.5dBu

Optical Inputs

TOSLink Optical Connector
 ADAT: 8 channels @ 48kHz
 ADAT SMUX: 4 channels @ 96kHz
 S/PDIF: 2 Channels @ All sample rates

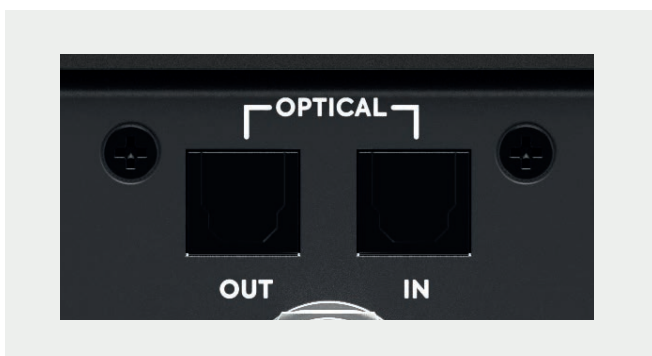

Digital Inputs and Outputs

iD24 features an optical input and an optical output. These can be set to operate using optical stereo S/PDIF or 8-channel ADAT using the iD Software Mixer. All i/o will operate at up to 96kHz, with ADAT dropping to 4 channels at sample rates of 88.2kHz or higher.

Running in S/PDIF mode, the optical i/o gives you 2 channels of audio in and out of the iD24 at sample rates up to 96kHz.

Running in ADAT mode, the optical i/o provides 8 inputs and outputs which are ideal for recording via external mic preamps.

The ADAT outputs could connect to an 8-channel DAC to provide additional outputs or to headphone distribution systems such as a Hearback™ System.

Please note, when using 88.2kHz and 96kHz as a sample rate with ADAT devices, you only have access to 4 channels of digital input and 4 channels of digital output due to how the ADAT protocol works at higher sample rates.

More information on how the iD Software Mixer is used to route to the optical outputs can be found under The Routing Matrix section of this manual.

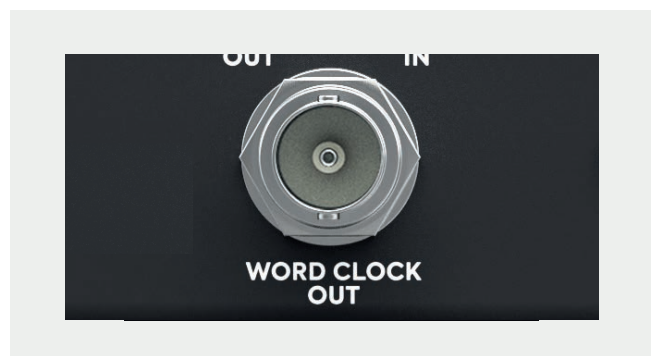

Word Clock Output

The iD24 also includes a BNC Word Clock output which allows you to clock multiple digital devices to the iD24's master clock and keep everything in sync.

The Word Clock output will send a clock signal at the same sample rate (44.1, 48, 88.2 or 96kHz) that the iD24 is operating at. This will occur regardless of whether the iD24 is being clocked internally or externally.

Hardware Features

iD24 with Single BNC Connection

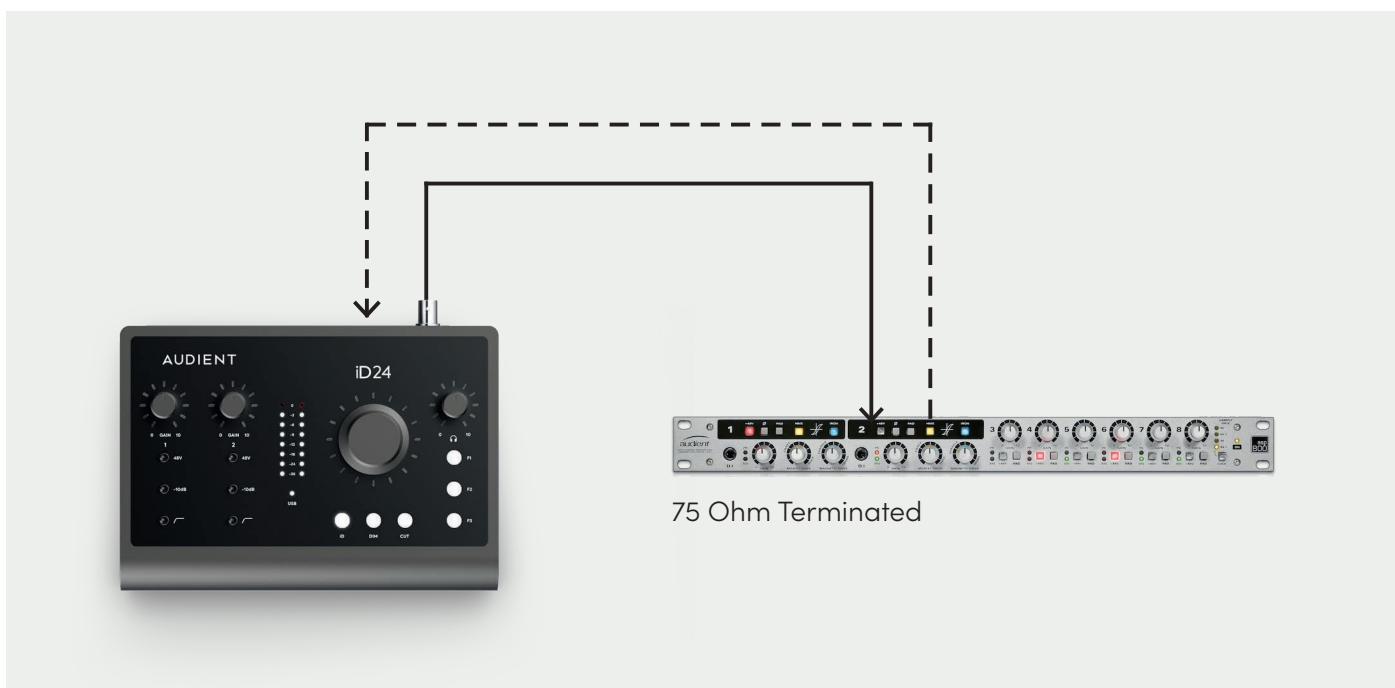

iD24 clocked via the Optical Port

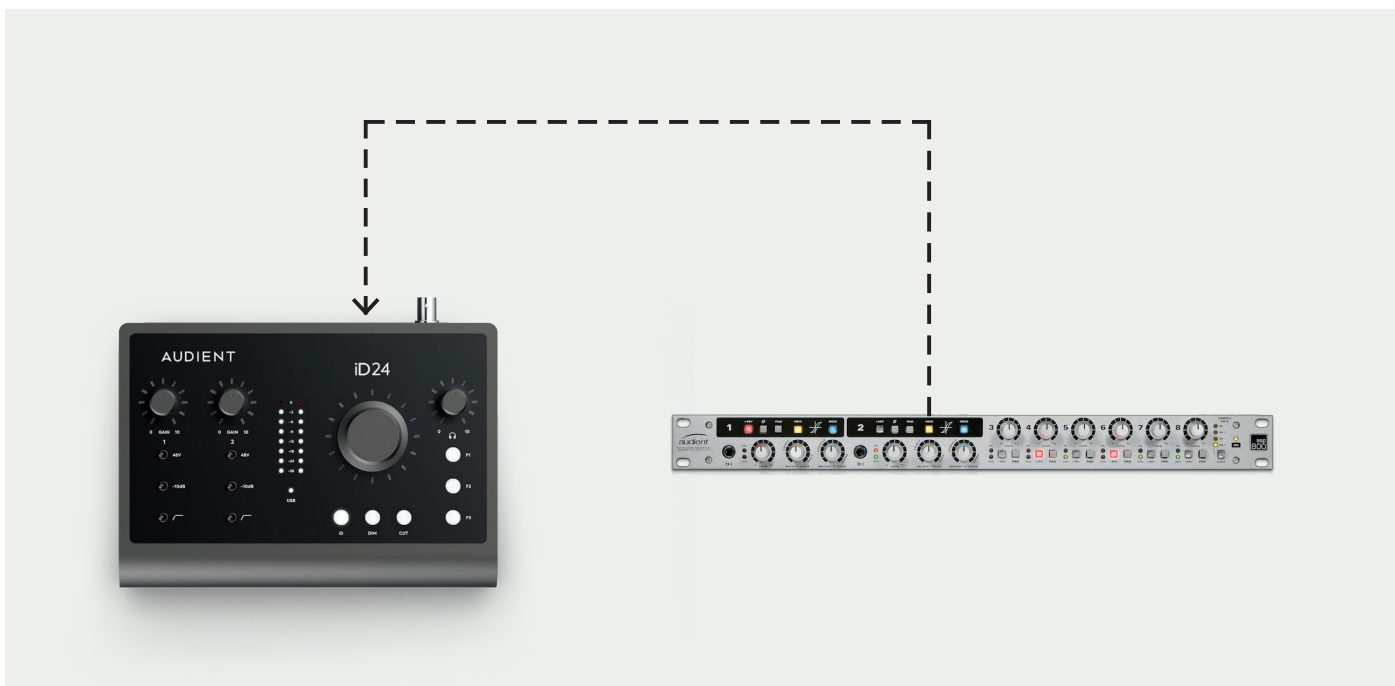

--- → Optical TOSlink Cable

————→ BNC Word Clock Cable

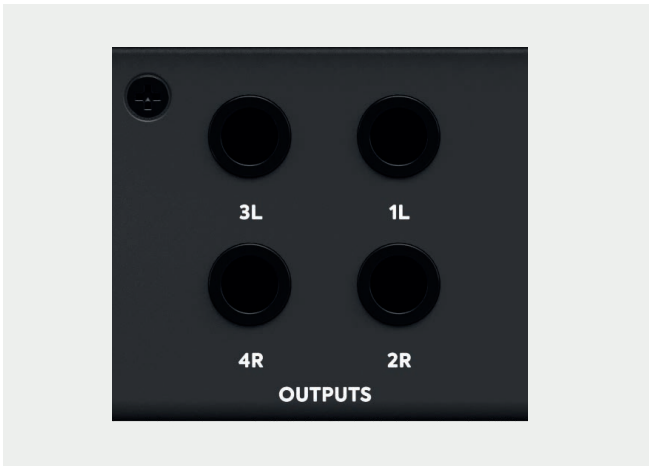

Speaker Outputs

iD24 has two pairs of stereo speaker outputs on the back panel in the form of balanced TRS jack connectors. The outputs are impedance balanced using the same topology as our flagship console, the ASP8024.

The outputs are fed from high-quality DACs (Digital to Analogue Convertors) sending clean audio to your speakers, perfect for critical listening.

You can use these outputs for more than just speakers. A good example of this is if you want to use a dedicated headphone amplifier for multiple musicians, you can connect this up to one or more of these outputs, This is configured in the iD Software Mixer.



Headphone Output

iD24 features an independent high-current headphone amplifier. This can be accessed using both the 3.5mm and 6.35mm sockets found on the front of the unit. The same audio signal comes out of both connectors simultaneously, so it does not matter which you plug your headphones into. You can also plug in two pairs at the same time.

The headphone output can comfortably drive a wide range of headphone impedances meaning that you will get great-sounding audio no matter what model of headphones you have.

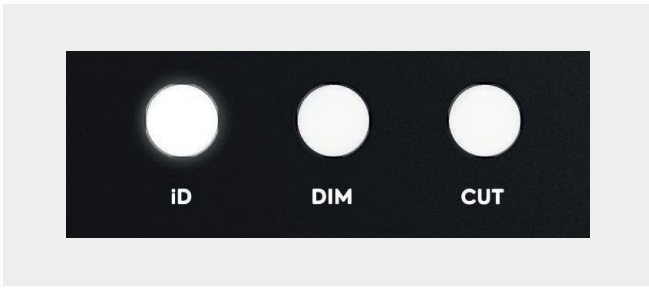

iD Button

The iD button is used to activate iD24's ScrollControl feature, which turns the encoder into a virtual scroll wheel allowing you to control compatible scrollable parameters within your DAW or plugins.

Simply hover your mouse over a scroll enabled parameter in your DAW and turn the encoder on the interface to adjust that parameter. Please note that this will not work on all DAWs as it relies on the DAW to have scroll wheel support.

Monitor Controls

iD24 provides excellent monitor control functionality using the large aluminium volume control and the separate headphone control. You also have dedicated DIM and CUT buttons to either reduce the level by a set amount, or to mute the speaker outputs entirely.

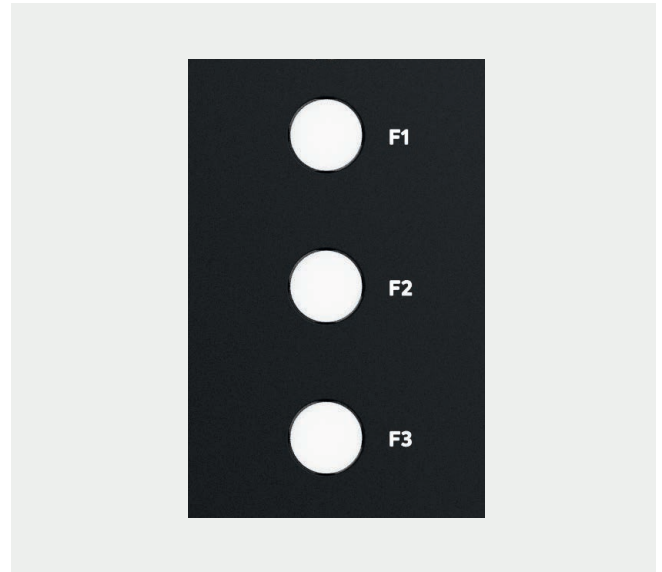

F-Keys

The three F buttons, F1, F2, and F3 are the function keys and allow you to activate a number of monitoring functions from the iD Software Mixer. More information on how to assign functions to the F-keys can be found on **page 32**.

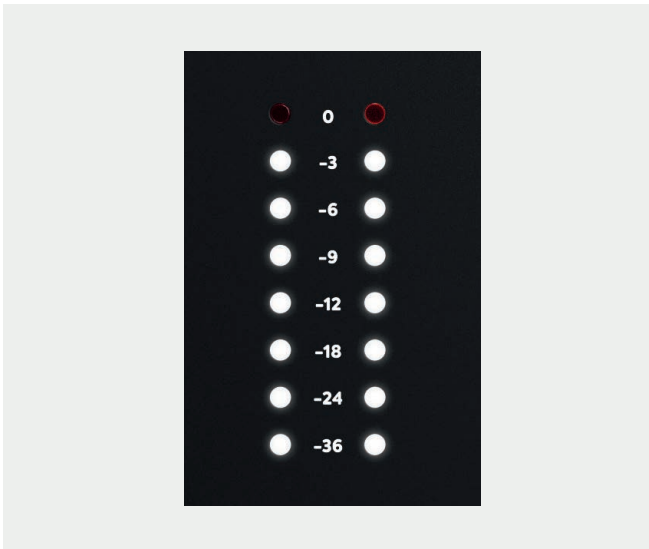

Hardware Metering

The 8-segment hardware meters indicate the playback level of your Main Monitoring Mix in the iD Software Mixer.

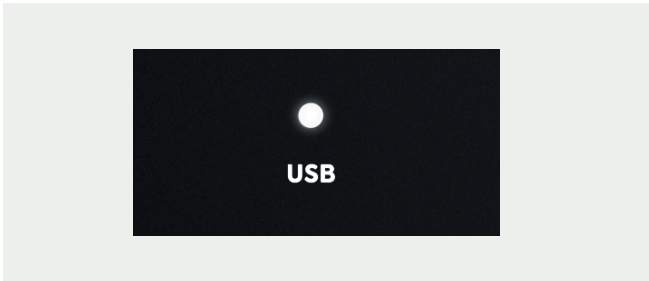

Status LED

The status LED indicates connection via USB to your computer. A solidly lit light means that there is stable communication between iD24 and your computer.



Kensington Lock

For those who work in educational establishments or in situations where your equipment is public facing and subject to possible theft opportunities, we have provided a Kensington lock hole to enable you to protect your iD24.

Software Features

Input Channels - Channel Types

The iD Software Mixer features three types of input channels:

Mic Inputs

These are the inputs where you will see the signal from the iD24's two analogue inputs.

Digital Inputs

These are the inputs from the iD's optical inputs. The number of digital inputs present on the iD Software Mixer depends on the digital input type (S/PDIF or ADAT) and the sample rate being used.

DAW Returns

These are the signals being played back from your DAW. The iD24 has six DAW Return Channels allowing you set up multiple cue mixes or sends to hardware outboard gear.

Using these three channel types you can build up your main monitor mix and up to two additional cue mixes.

It's important to note that the iD Software Mixer only controls the monitoring of the iD24. Changes made to the iD Software Mixer won't affect the level present in your DAW or audio software.

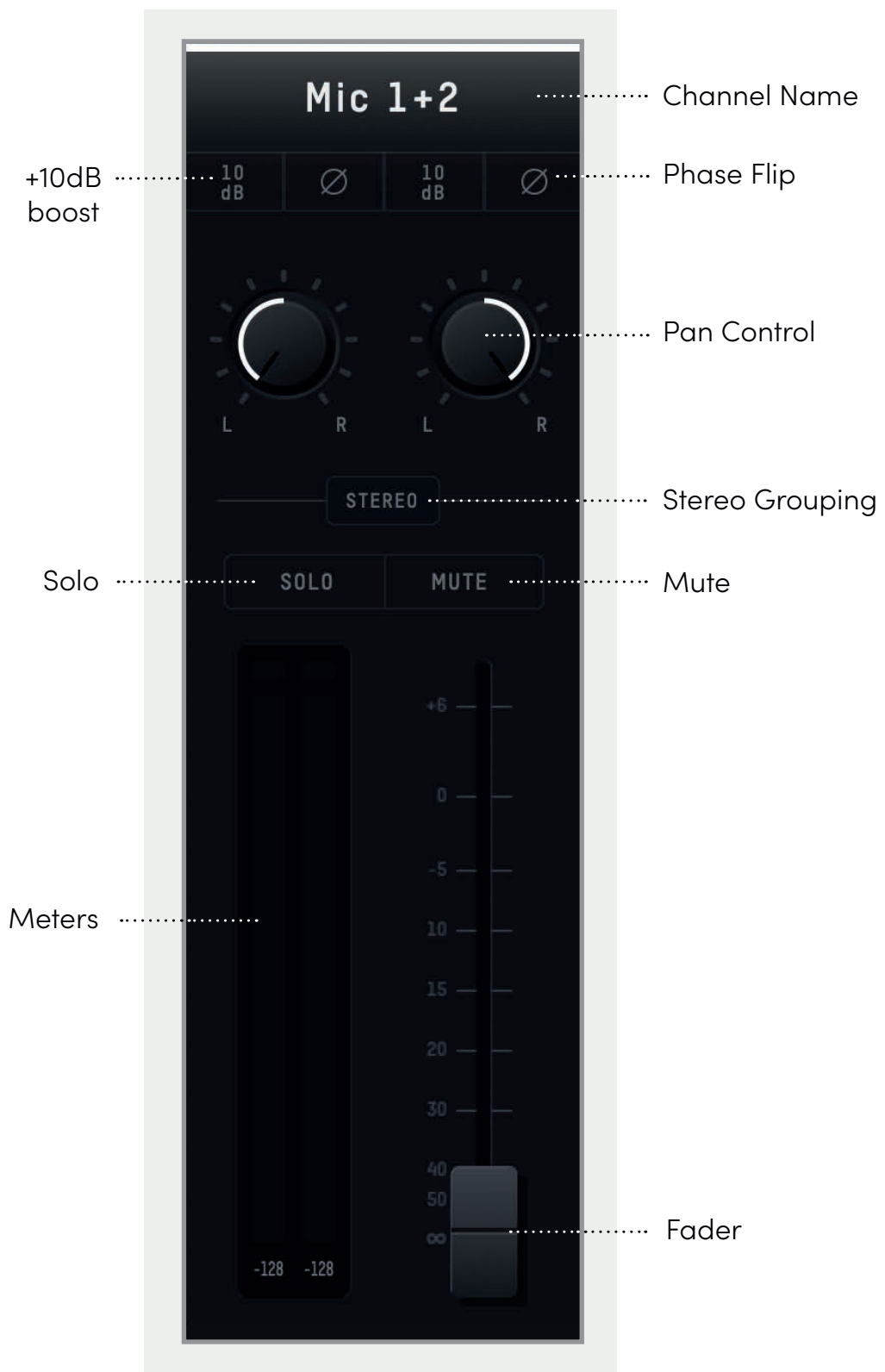

Channel Features

Channel Name

By double-clicking on the name of the channel you can rename it to help you organise your iD Software Mixer. You could name a channel 'Kick' or 'Snare' for example.

+10dB Boost

Selecting this will boost the incoming signal by +10dB for recording quiet sources. This will also affect the audio being fed into your DAW.

Phase Flip

Inverts the polarity of the signal by 180° to stop phase cancellation. This is useful if you are micing the rear of a guitar amplifier or the underside of a snare drum.

Pan Control

Allows you to send the audio to the left, to the right or anywhere between on your Main Monitor Mix or Cue Mixes.

Stereo Grouping

Allows you to group two adjacent channels together into a stereo channel with a single fader controlling the level of both channels. When a channel is stereo grouped, the pans will automatically be set to hard left and hard right.

Solo

The Solo button mutes all other channels other than the one that is currently soloed. Multiple channels can be soloed at one time.

Mute

The Mute button stops this channel from outputting audio whilst it is engaged.

Fader

The fader controls the amount of signal that is sent to the currently selected mix. This can be set to anywhere between -inf dB to +6dB.

Meter

The meter shows the current signal level in dBFS. Should the signal level exceed 0dBFS then the peak indicators will illuminate red to indicate a peak. The peak indicators can be turned off by clicking on them. You can also turn off all peak indicators using Alt + Click.

Master Section Features



Channel Features

Mix Selection

Clicking on one of the mix tabs allows you to make changes to that mix. When a mix is selected, it expands to reveal additional controls for that mix.

Cue Mix Name

Double-clicking on a Cue Mixes name allows you to rename the Cue Mix. If, for example, you were creating mixes for two separate band members, you could name them 'Drummer' and 'Guitarist'.

Mix Solo

The Solo button allows you to audition each of the Cue Mixes through your monitors.

Mix Level

The Mix level allows you to control the overall level of the Cue Mix that is sent to the outputs.

Mix Meters

The Mix meters show the master signal level of the selected mix.

Chronometer

The Chronometer allows you to see not only the current signal level but also the signal level from a few seconds previously.

This can be great to track down a sudden loud transient on a particular cue mix or to

monitor the change in level over time as you make changes to a mix.

Channel Views

These three buttons allow you to control which of the three channel types are shown in the mixer. If for example, you weren't using the digital inputs for a particular project, you can simply hide the optical channels by clicking 'OPT'.

Main Mix Volume

The large virtual knob in the master section controls the Main Mix output which is used to adjust the volume of the audio being sent to your speakers. This is linked to the hardware encoder on the unit itself.

Monitor Controls

These six buttons control various aspects of iD24's monitor controller capability. The function of each control can be found below:

- **TB (Talkback)**

The Talkback button switches talkback on and off. More information regarding talkback and its various settings can be found in the 'System Panel' section of this manual.

- **∅ (Phase Flip)**

Pressing this switch flips the phase of one side of the stereo field. Used in conjunction with the Mono button, this can be a great way to remove centred elements from a mix in order to hear the hidden elements of a mix.

- **Mono**

The Mono button sums the stereo outputs down to mono. This can be used to quickly check the mono compatibility of your mix to make sure it'll sound great almost anywhere!

- **ALT**

Alt allows you to quickly switch your monitor path to a secondary set of monitors to let you check how your mix translates on various speakers.

You can select which outputs the 'ALT' monitor control flips to in the System Panel.

- **DIM**

Reduces the output level by a preset amount which can be great if you get a call or need to quickly chat to someone during a session.

- **Cut**

Cuts all signal currently being sent to the Main Mix of the iD24.

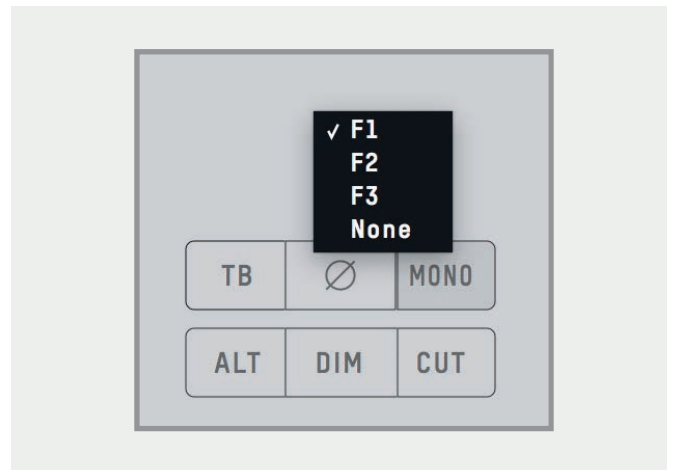

Assigning F-Keys

Various functions of the iD mixer application can be assigned to the Function Keys of the iD24 to allow you to quickly control your monitoring at the click of a button.

To assign a monitor control to an F-Key, simply right click on the control and select the F-Key.

System Panel Features

The screenshot shows the 'SYSTEM PANEL' window with the 'ROUTING' section active. On the left side, there are several control sections: 'DIGITAL INPUTS' with 'ADAT' and 'S/PDIF' options; 'DIGITAL OUTPUTS' with 'ADAT' and 'S/PDIF' options; 'DEFAULT CLOCK SOURCE' with 'INT' and 'DIG 1' options; 'MONO MODE' with 'L', 'C', and 'R' options; and 'TRIM SETTINGS' with 'DIM' and 'ALT' knobs. The main routing area is divided into 'ANALOGUE OUTPUTS', 'DIGITAL OUTPUTS 1-8', and 'TALKBACK'. Under 'ANALOGUE OUTPUTS', there are three stereo pairs (1+2, 3+4, 5+6) with volume faders and a mute button. Under 'DIGITAL OUTPUTS 1-8', there are buttons for 'MAIN MIX', 'ALT SPK', 'CUE A', 'CUE B', and 'DAW THRU'. The 'TALKBACK' section is currently empty. Callouts on the left point to 'Digital Input Format', 'Clock Source Selection', 'Mono Mode', 'Dim Level', and 'Alt Speaker Level'. Callouts on the right point to 'Output Routing Selection' and 'Routing Matrix'.

Talkback Source

Input Source

The left screenshot shows the 'TALKBACK' section of the routing interface. It has 'INTERNAL' and 'EXTERNAL' radio buttons, with 'EXTERNAL' selected. Below it is a 'DEVICE' dropdown menu showing 'MacBook Pro Microphone'. The right screenshot shows the 'INPUT SOURCE' section. It has 'INTERNAL' and 'EXTERNAL' radio buttons, with 'EXTERNAL' selected. Below it is an 'INPUT SOURCE' dropdown menu showing 'Mic 1'. Dotted lines connect the labels 'Talkback Source' and 'Input Source' to their respective sections in both screenshots.

Talkback Device

System Panel Features

Digital I/O Format

Allows you to select whether the optical input uses ADAT or S/PDIF digital format.

Preferred Clock Source

The Clock source can be selected from either the internal clock or the optical input. More information about choosing a clock source can be found in the clocking section of this manual.

When using an external clock source the indicator beside the selector shows the current status of the clock on that input.

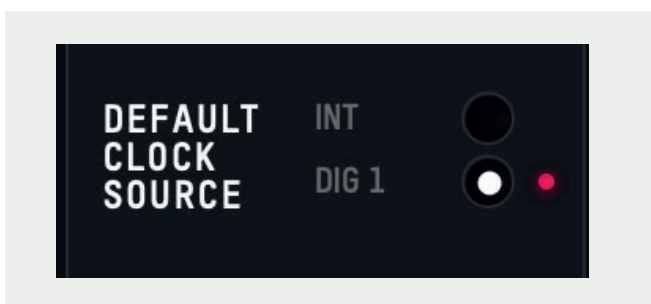

- **Red** - No clock signal detected on input
- **Amber** - A clock signal is detected but at a different sample rate to iD24
- **Green** - A clock signal is detected and is at the correct sample rate.

For an external clock source to be working correctly you would want the indicator to be green.

Mono Mode

When iD24's Mono feature is engaged this option controls whether the mono signal is sent to the left, right or both monitors.

Dim Level

When iD24's dim function is engaged, this control defines how much the level is reduced by.

ALT Speaker Level

This control defines the level drop/boost when iD24 is switched to ALT speaker mode. This is used to balance levels between different speaker brands.

Output Routing Selection

Opens the Routing Matrix for either the Analogue Outputs, Digital Output or the Talkback channel.

iD Mode

Controls whether the iD button engages ScrollControl or one of the monitoring functions.

Routing Matrix

The Routing Matrix allows you to control the audio source for each of iD24's outputs from the following options:

- **Main Mix** - This takes signal from the Master Mix of the iD Software Mixer. This is what is usually used for most standard playback.
- **ALT** - This takes signal from the Master Mix but only when the Alt speaker mode is active.
- **Cue A & B** - This takes signal from the two cue mixes which can be created using the iD Software Mixer. Please note that the hardware volume control does not affect these mixes and the Cue's have separate trims which can be adjusted when the Cue Mix is selected in the Main Mixer Window.

- **DAW THRU** - This allows you to route to outputs exactly as they would appear in your DAW. For example, if you set Analogue out 1+2 to DAW THRU, anything your DAW sends out to Outputs 1+2 will be sent directly to Analogue outputs 1+2.

Please note that in DAW THRU, the channel in question will bypass any volume control and audio will be passed at full scale. If this output is sent to a set of monitors without inline attenuation, this may be very loud.

The only exception to this is the headphone outputs where the volume control will still function.



Talkback Source

The Talkback source allows the talkback input to be taken from one of iD24's internal inputs or from an external device connected to the host computer (such as a built-in microphone or USB microphone).

When you select an internal input as your Talkback channel, the corresponding channel in the iD Software Mixer will be changed to a talkback channel which will have a TB button in the centre. If using an external device, the talkback signal will appear on channel DAW 6.

Talkback can be turned on or off by pressing the TB button on that channel, the TB button in the master section or using one of the F-keys if assigned to the TB function.

The Talkback is only sent to the CUE mixes as you would not want your talkback to also playback through the Main Speakers. Therefore, faders will only appear for the Talkback channels on the Cue mixes, not on the Main Mix.

Talkback Device

If an external device is selected then this allows you to select which connected device is used.



Saving & Loading Mixer Presets

To allow you to quickly setup your iD Software Mixer during a session you can save and load various presets. This is great if you are moving between different recording scenarios quite often.

Mixer presets can be saved and loaded in two ways:

- Using the File menu and selecting either Save or Open.
- Using standard keyboard shortcuts :

Save: Mac - **Cmd + S**

Windows - **Ctrl + S**

Load: Mac - **Cmd + O**

Windows - **Ctrl + O**

Saving a Preset

To save a preset, simply setup your mixer the way that you'd like. Then select **File > Save** as explained above. The iD Software Mixer window should then show the **'Save mixer Configuration'** dialog.

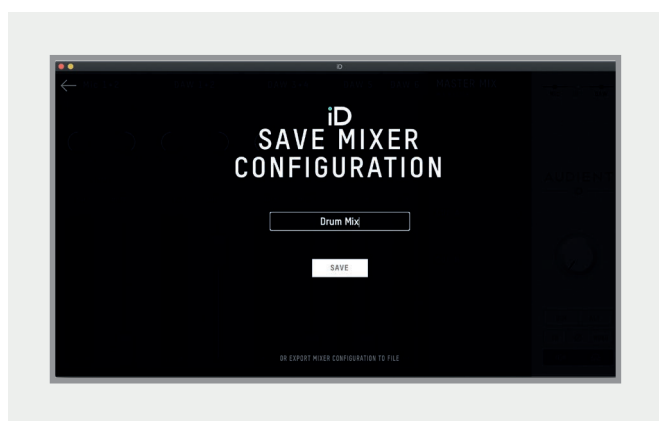

Simply enter the name of your preset and press the **'Save'** button.

It is also possible to export your preset files in order to send them to friends or to simply save them within your DAW session files for easy recall later on. To do this, select **Export Mixer Configuration** at the base of the Save screen.

Loading a Mixer Configuration

To load a previously saved preset, select **File > Open** to bring up the **'Load'** screen.



The previously saved configuration will appear in a list. Select the configuration you wish to use and click Load.

You can also open a mixer configuration directly from your computer's file system by selecting **'Load From File'** located at the bottom of the window.

Audio Loop-back

iD24's Software Mixer has the ability to loop-back audio so you can record or stream audio from different applications on your computer using the dedicated Loopback channels.

- These Loopback channels are located on input channels 11+12 and using the 'Input Routing' option of the 'Setup' menu found in the menu bar when using the iD Software Mixer. Here you can select the audio source you would like to be sent to these Loopback channels.

On macOS:

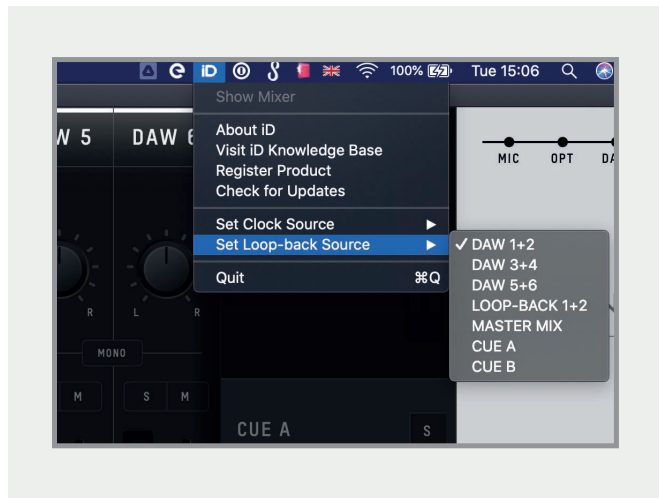

The various sources you can select from in the menu are as follows:

- **DAW 1+2** - Any audio being sent to outputs 1+2 of the iD24
- **DAW 3+4** - Any audio being sent to outputs 3+4 of the iD24
- **DAW 5+6** - Any audio being sent to outputs 5+6 of the iD24
- **Master Mix** - The audio mix created in the iD Software Mixer on the Main Mix tab
- **Cue A** - The audio mix created in the iD Software Mixer on the CUE A tab
- **Cue B** - The audio mix created in the iD Software Mixer on the CUE B tab

On Windows:

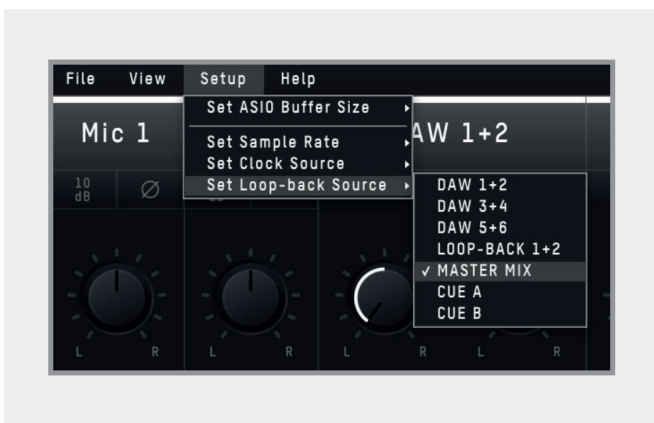

Using the Loop-back Mixer

To record or stream your loopback mix in your audio software, you would simply need to select the Loopback channels as your input channels in your audio software. Depending on the software you are using, they may appear as either Loopback 1+2 or Input 11+12. For example, the image below shows how you would select the loopback input in Logic Pro X.

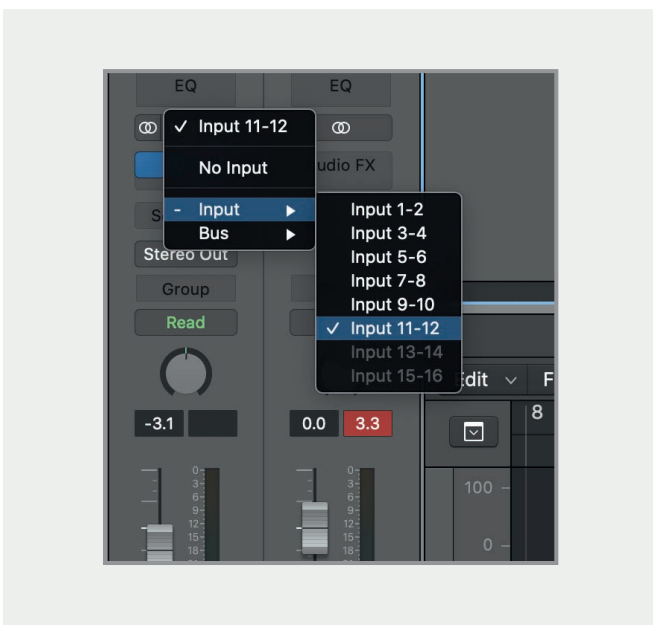

A similar process would be used in other software. If you are unsure on how to adjust the input on your audio software, we'd recommend referencing the user manual for your software. On Windows, you may also need to adjust the audio device in your System settings from Analogue 1+2 to Loopback 1+2.

Please note: Some software will not allow you to adjust the input channel you are using and will just default to Channels 1+2. This limitation with some software can stop you from using loopback with this software as you are unable to select Channels 11+12.

Recording/Streaming your Loop-back Source

Once you have selected the Loopback Inputs as your audio source in your recording/streaming software, you can now set up your Loopback mix using the iD Software Mixer.

The first step is to decide which source you will use for your Loopback stream.

If you wish to combine audio from your computer and microphones/instruments into a single mix then selecting either the Main Mix or one of the Cue Mixes is the best option as you can use the faders in the iD Software Mixer to send multiple channels to the same mix.

For example, below you can see the CUE A mix being used as the Loopback source with the Mic 1 and DAW 1+2 being sent to the CUE A mix. When recording the Loopback inputs with this setup, you would hear both the Mic Channel and the Computer Playback on a single stereo channel.

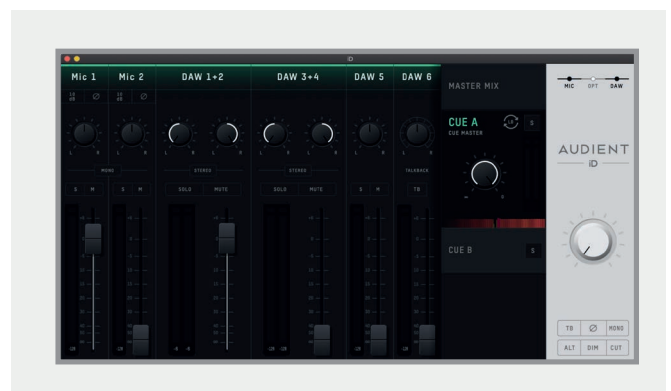

Otherwise, if you only wish to send audio from the computer without any microphone signal, you can just use one of the DAW Channels.

When selecting a channel or mix as the loopback source, a small loopback icon will appear on that channel/mix so you can check which source the loopback feature is being fed from with just a quick glance.

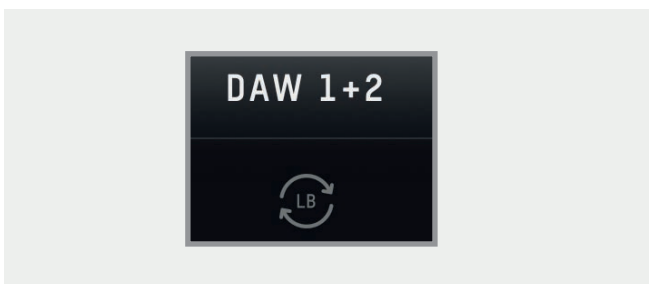

Adjusting your Output Channels

When setting up your loopback mix, you may wish to set up your computer audio so it is sent to DAW 3+4 or DAW 5+6 in order to keep it separate from your Main Monitor Mix which typically will be sent to DAW 1+2.

In most DAW software, you should be able to create a new output send or adjust the output channel. The process to do this will vary so we recommend that you reference the user manual for your chosen software on how to adjust the output channel.

On Applications that don't give the option to adjust the output channels (Media Players, Video calls...etc) then you may need to adjust this in the System Settings.

On macOS:

Open Finder and navigate to **Applications > Utilities > Audio MIDI Setup**. In the Audio MIDI Setup Utility, select the iD24 from the list of devices. Select the **'Output Tab'** and click **'Configure Speakers'**. You can then select which channels on the iD24 you would like to be your left and right outputs. Channels 3+4 will relate to DAW 3+4, Channels 5+6 will relate to DAW 5+6...etc

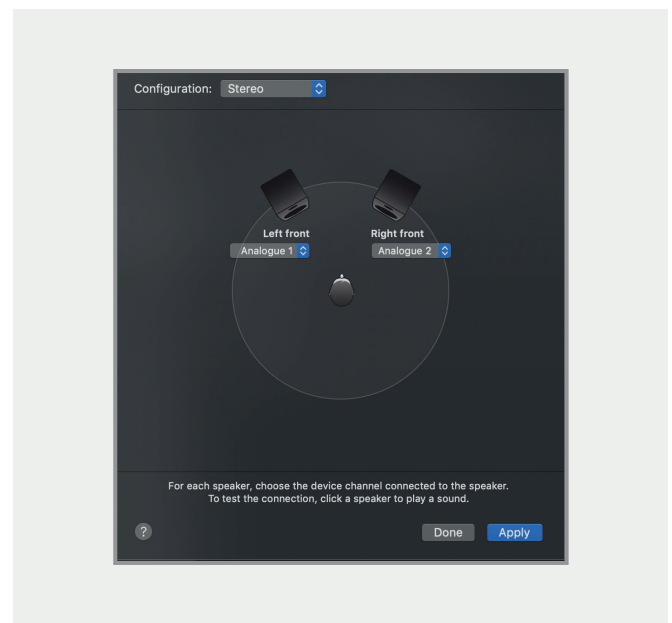

On Windows:

Open the **'Start'** menu and select **'Settings'**. In Settings, navigate to **'System > Sound'**. Using the **'Output Device'** drop-down menu, you can select the channels you wish to use for your output. Again, channels 3+4 will relate to DAW 3+4, Channels 5+6 will relate to DAW 5+6...etc

Menu/Task Bar Icons

MacOS

On MacOS, the iD icon appears in the menu bar in the top right hand corner of the screen. This gives you quick access to various functions of the iD24. Please note that some functions are only visible when the iD24 is connected to the Computer



Show Mixer

Opens the iD Software Mixer. If the mixer is already open, this option will be greyed out. The Mixer cannot be opened unless the iD24 is connected to the Computer.

About iD

Displays information regarding the current version of the iD mixer application.

Visit iD Knowledge Base

Opens a browser window for the Audient Helpdesk with helpful articles and FAQ's.

Register Product

Will open the registration screen allowing you to register your product to Audient ARC if you have not already done so as part of the initial setup.

Set Clock Source

Allows you to quickly adjust the clock source between the internal and optical clocks.

Set Loopback Source

Here you can select which Output Channel or Mix will feed the Loopback inputs.

Check for Updates

The iD application will check with the Audient update server for any available firmware updates for iD24.

Quit

Fully closes the iD application.

Windows

The Windows taskbar icon has all the same options of the MacOS menu bar icon but also includes some Windows specific options.



Set Sample Rate

Sets the operating sample rate of iD24. 44.1, 48, 88.2 and 96kHz are the four options available.

Set ASIO Buffer Size

Sets the buffer size of the iD24 between 16 and 4096 samples. Higher sizes will take processing load off your computer but will cause increased latency.

Firmware Update

Occasionally Audient will release a firmware update for iD24 in order to address bugs, improve compatibility and add new features. Therefore, you may wish to check periodically for any updates.

This can be done by navigating to the Window menu and selecting '**Check for Updates**'.

The iD Application will then check with our update server if any updates for iD24 are available. If there is an update available then you will be prompted to install the latest version.

Now click '**Next**' and you'll be prompted to stop any playback through iD24. Click '**Update**' and the update will begin. iD24 may turn off and on a number of times.

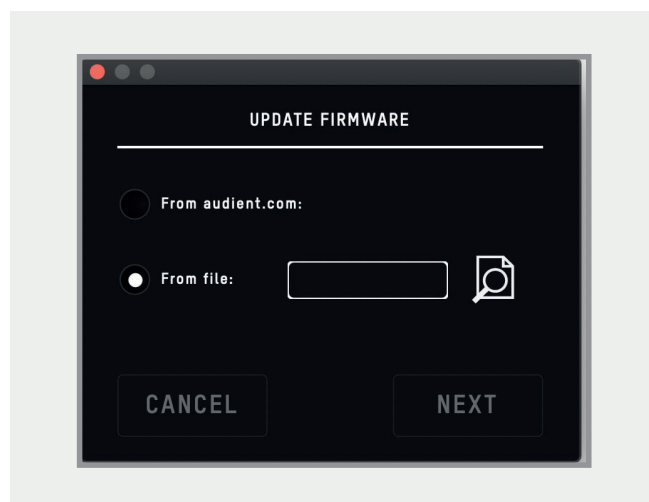

Keyboard Shortcuts

Keyboard Shortcut Index

To allow you to find all shortcuts for the mixer application in one place without having to go through each page of this manual please refer to this table:

Location	Mac	Windows	Description
Faders	Alt + Click	Alt + Click	Resets fader to unity gain (0 dB)
Pans	Alt + Click	Alt + Click	Resets pan pots to central position
Solos	Cmd + Click	Ctrl + Click	Clears all solos if clicking on a solo'd channel Overrides all other solos (for solo exclusive) if clicking on an unsolo'd channel
Meters	Alt + Click	Alt + Click	Clicking on peak hold indicator will clear all clip indicators
System Panel	Cmd + S	Ctrl + S	Save mixer configuration
	Cmd + O	Ctrl + O	Load mixer configuration
View Modes	Cmd + 1	Ctrl + 1	View Mic/Line Input
	Cmd + 2	Ctrl + 2	View Optical (Digital) Inputs
	Cmd + 3	Ctrl + 3	View DAW Mix Inputs
	Cmd + 4	Ctrl + 4	View System Panel

Please check the iD24 page online at audient.com/products/iD24 for the latest iD Application updates.

More shortcuts may be added without notification.

DAW Setup



Pro Tools Setup

Operation with Pro Tools

If using Windows, ensure that you have followed the installation instructions found on **page 12**.

With iD24 connected, launch Pro Tools and ensure that a new session is created at the desired sample rate. If you are using Windows, make sure that you have already set your Latency and Buffer Size settings in the iD System Tray before opening a project. Changing these mid session will result in Pro Tools needing to restart.

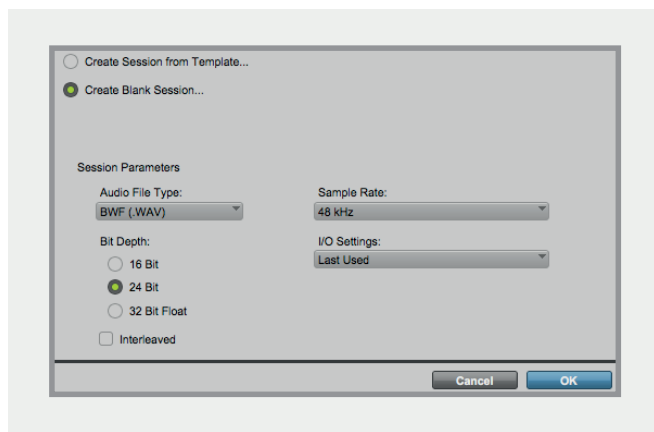
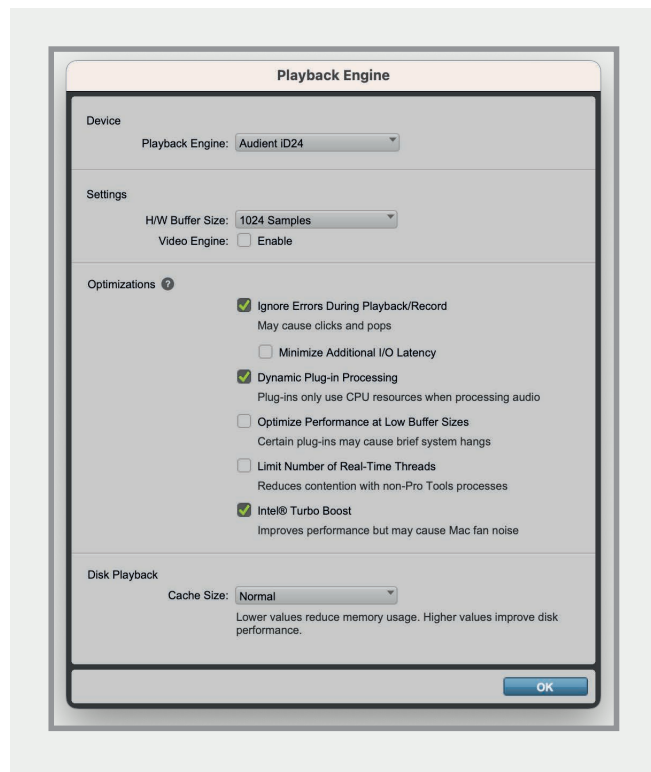

Playback Engine

Go to **Setup > Playback Engine...** and ensure that iD24 is set as the active playback device.



I/O Setup

Go to **Setup > I/O...** to label your inputs and outputs and ensure that iD24 is correctly reporting 10-inputs and 6-outputs and from Pro Tools.

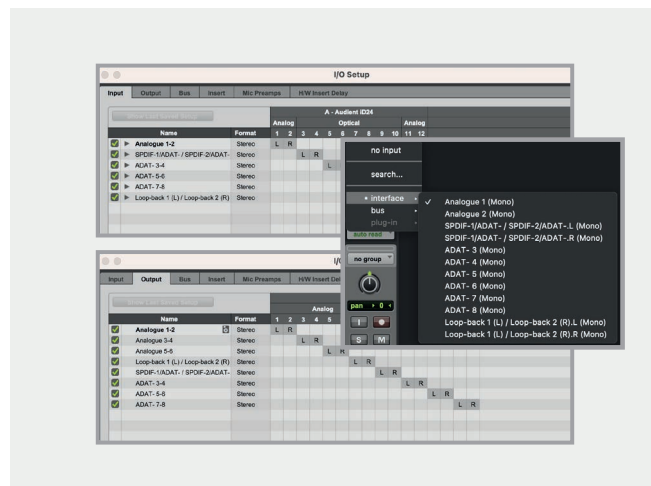

For more Pro Tools information consult your Avid user manuals & documentation.



Logic Pro Setup

Operation with Logic Pro

Once iD24 has been successfully installed following the steps detailed after **page 11** of this manual, launch Logic Pro and check the following:

Logic Pro > Preferences > Audio

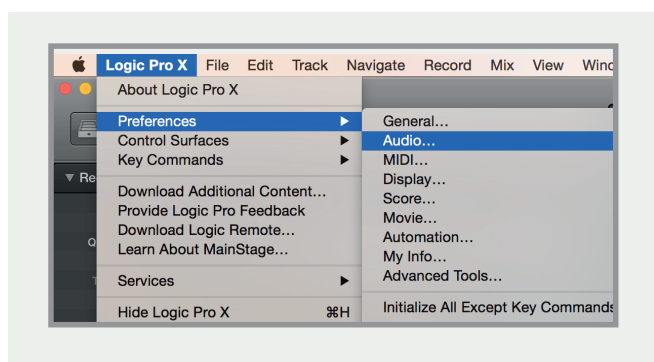

Ensure that iD24 is selected as the active audio device and set the buffer size (to affect system latency). If you are experiencing issues with playback stability and CPU loading, try increasing the buffer size. This appears with **'overload'** errors and/or pops and clicks and distortion in the audio.

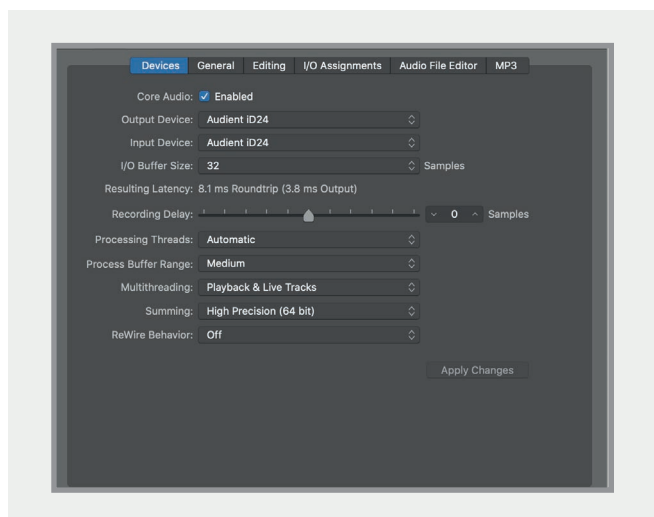

Logic Pro Setup

If you are using the iD mixer to monitor input signals while recording, be sure to disable Logic's software monitoring to avoid phasing as the same source will be heard twice with a short delay between the low latency DSP signal and the delayed software monitoring signal.

Assigning I/O

All of iD24's input and output channels will be available to Logic for routing. There are a total of 10-inputs and 14-outputs reported from the driver. You can rename input and output channels to whatever you wish using the I/O label function. This is a great way to keep things organised.

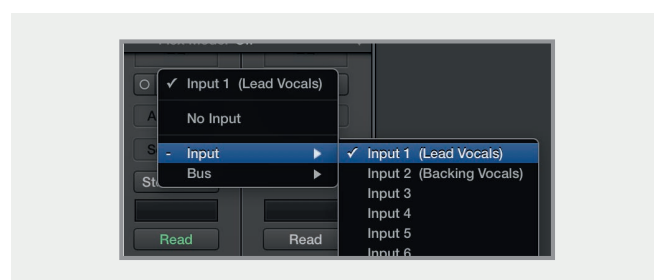

Mix > I/O Labels

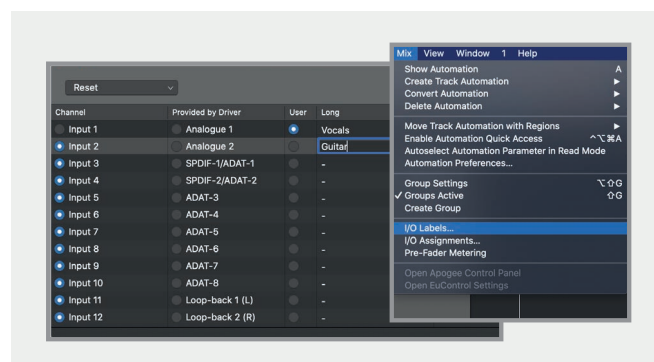

Operation with Logic Pro

If you are using an external clock source (ADAT or S/PDIF) to clock iD24, please ensure that your Logic Pro project is set to the same sample rate when recording and playing back in a session, otherwise things may sound a bit sharp or flat!

File > Project Settings > Audio

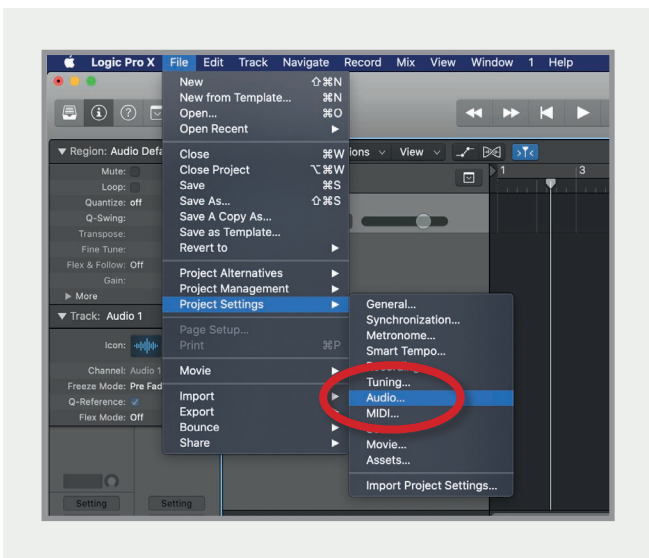

If you are using the internal clock in iD24, setting the sample rate via Logic Pro will update the iD24 sample rate to follow your session.

There may be a slight pause as the system re-clocks. This is normal.

This can be verified in Audio MIDI Setup.

Macintosh HD > Applications > Utilities

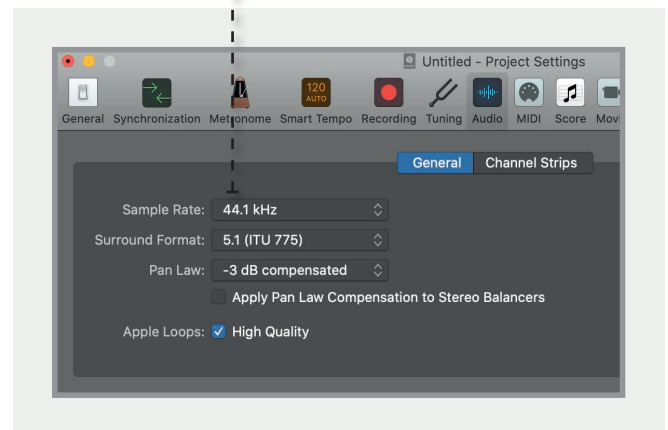
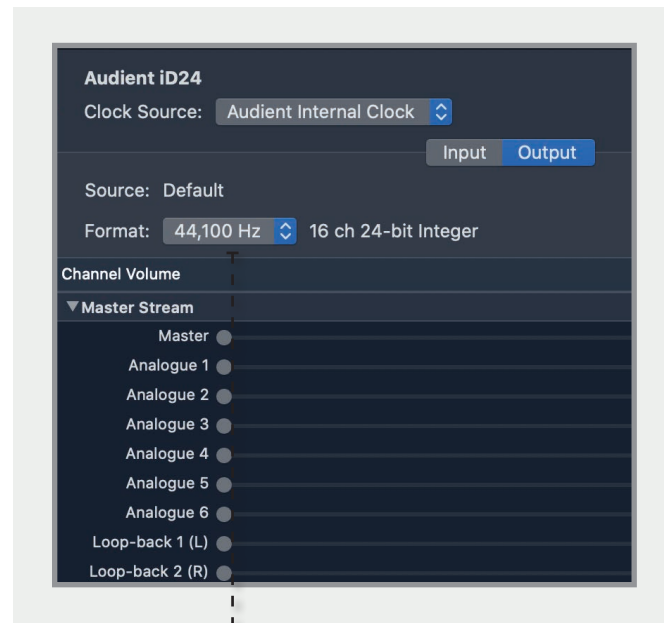

For more Logic Pro information please consult your Apple user manuals & documentation.



Cubase/Nuendo Setup

Operation with Cubase / Nuendo

Once iD24 has been successfully installed following the installation process that can be found at the start of this manual, launch Cubase or Nuendo and head straight for the 'Studio' menu:

Devices > Device Setup...

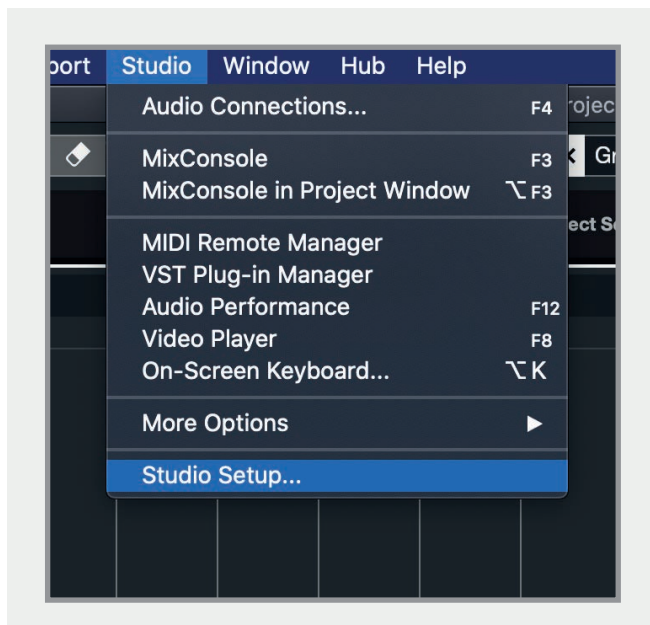

Select 'Audio System' from the list of options.

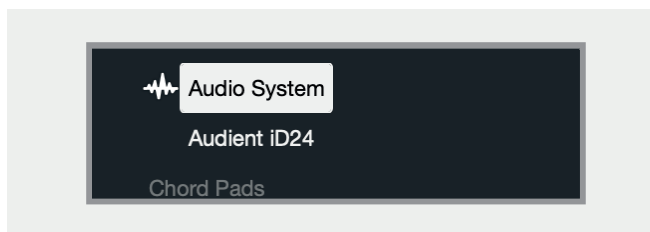

Select 'Audient iD24' in the dropdown menu to ensure that Cubase / Nuendo addresses the iD24 device driver.

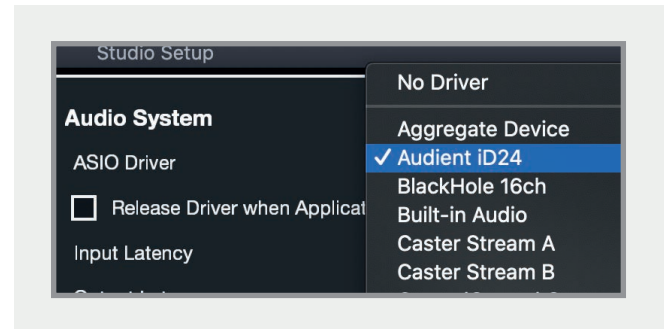

Click on Audient iD24 in the side menu. Here you will see the main iD24 information, where clock sources can be set as well as activating i/o ports. Be sure to click Externally Clocked if clocking from another digital device via ADAT or SPDIF.

I/O ports can be renamed in the device panel such that they better represent what you connect to them (for example Main Monitors, Headphones). This is useful as any names chosen here will be those displayed when assigning i/o on track input/output channel routing.

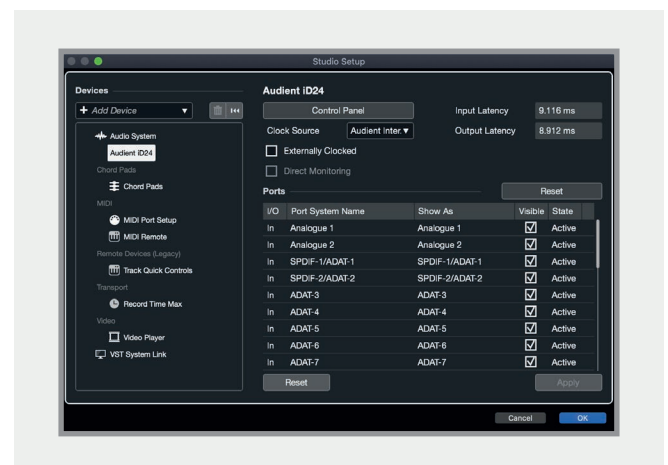



Cubase/Nuendo Setup

Operation with Cubase / Nuendo

Buffer sizes can be set in the control panel within the VST devices display. It is ideal to keep them quite high to reduce CPU loading if you use the iD mixer as the input monitoring device while recording.

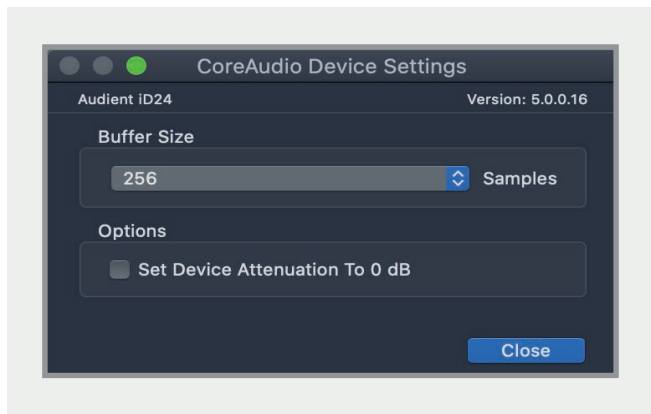

Close the Studio Setup panel and navigate to the Audio connections panel:

Studio > Audio Connections (F4)

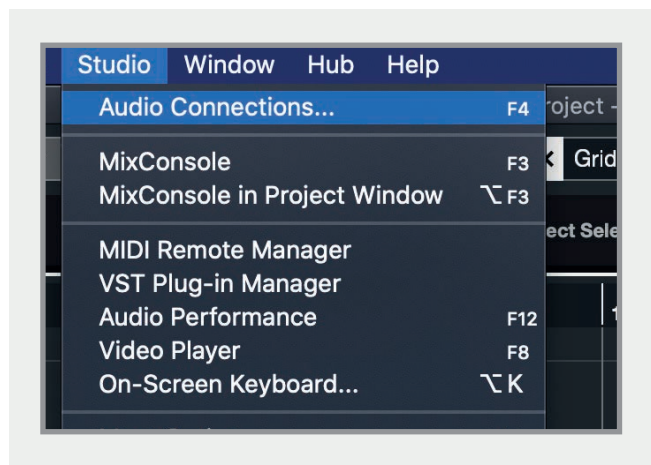

Here you can ensure that all buses have been created in Cubase / Nuendo and therefore all ports are addressable in your session. Add new buses and assign them to the necessary i/o if required.

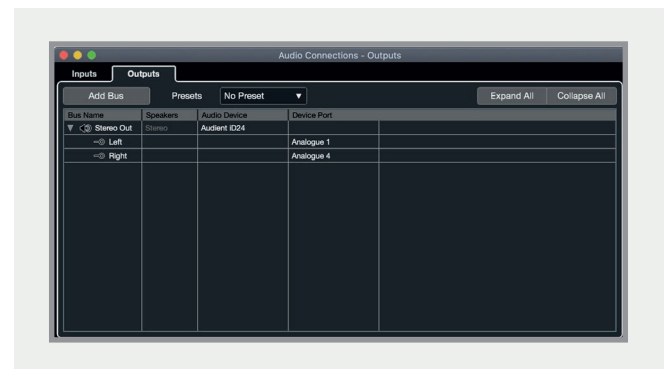

Bus types can be set (mono / stereo) and the VST control room section can also be used. For more information regarding set-up please consult your Steinberg user manuals and documentation.



Ableton Live Setup

Operation with Ableton Live

Once iD24 has been successfully installed following the installation process that can be found at the start of this manual, launch Ableton Live and head straight to:

Live > Preferences > Audio

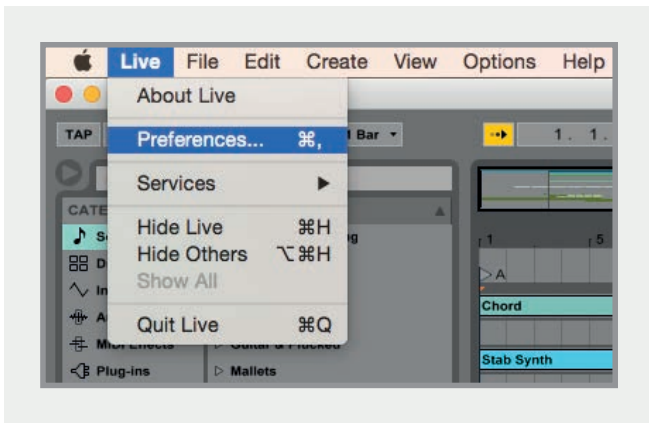

Here navigate to the Audio tab and make sure that iD24 is assigned as the playback device.

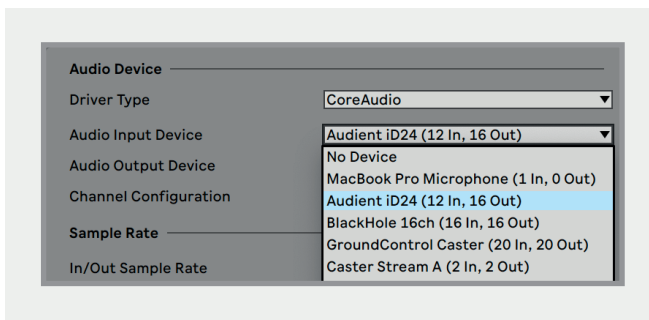

For more information about setting up audio i/o refer to your Ableton Live user manuals & documentation.

In the Live Audio Preference panel you can set an appropriate buffer size (this can be kept high if you are monitoring input signals for recording via the iD mixer. Ensure that iD24 reports as a 10-in, 14-out device to Live.

If necessary you can limit the number of i/o channels reported as active inputs (from the driver) in Live by using the input and output config tabs.

This is an excellent feature to help reduce CPU loading if all channels are not required.

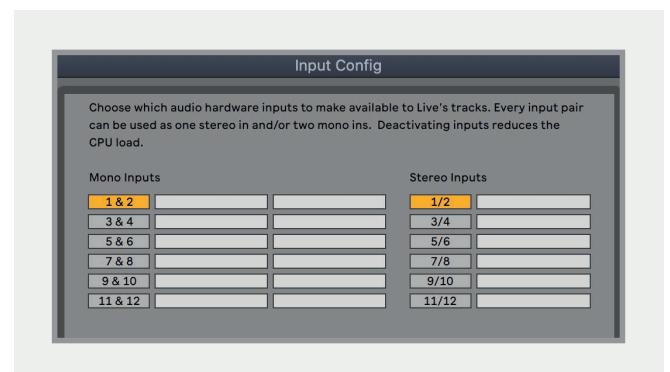
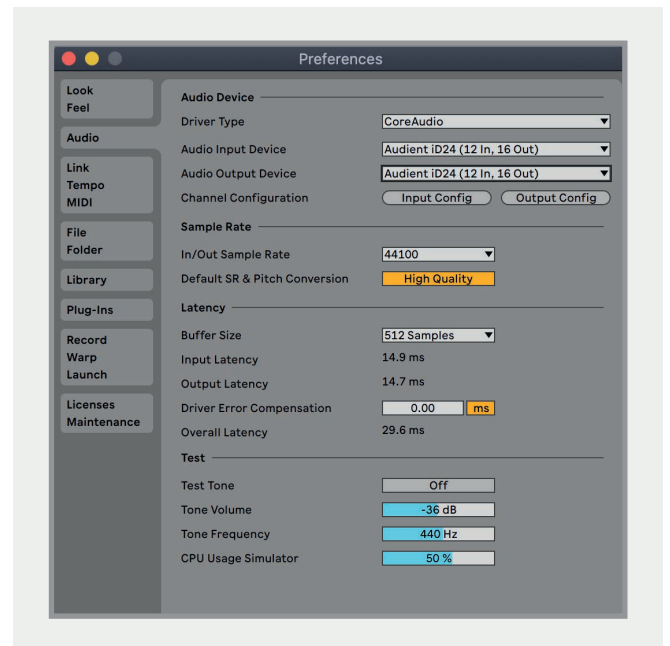

Troubleshooting & FAQ

Troubleshooting

“The unit will not power on”

Double check that the USB cable is plugged in. If it still won't power on, try using a different USB port on the computer and possibly even a different USB cable. If you are using a USB hub, please try plugging iD24 directly into the computer.

“I get clicks and pops on DAW playback”

This is most likely to do with setting the buffer size too low for your computer. This can be caused by running very large projects with a lot of plugins and virtual instruments. Experiment with higher buffer sizes. Typically you want small buffer sizes for tracking or recording software synths to keep the latency low. However when mixing it is fine to set a slightly higher buffer size as latency is not so much of a problem.

“When I connect to my computer, I cannot play any audio out from iD24”

Firstly double check that the USB cable connecting iD24 to your computer is functional and attached at both ends.
Troubleshooting & FAQ.

Double check that iD24 is set as the active playback device in your DAW and computer:

System Preferences > Sound > Output Tab > Audient iD24 (macOS)

Control Panel > Hardware and Sound > Sound > Manage Audio Devices > Audient iD24 (Windows)

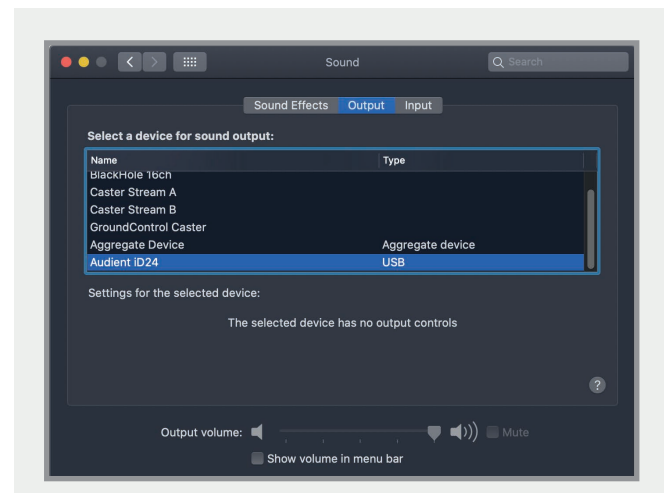

Launch the iD mixer application to activate communication between your computer and iD24. This only needs to be done once straight after power up. Once iD24 is set to the operational state you desire, you can quit the iD application and it will continue to function as intended.

In the software mixer, locate the DAW channels by pressing the DAW view button and increase the level of DAW 1+2 fader.

Troubleshooting

“I have clocking issues which include iD24 not locking to external ADAT or SPDIF devices or operating at the incorrect rate compared to my session”

If there is an issue with syncing of an external device, the Status LED in the System Panel will be red or yellow. If the status light is red then iD24 cannot detect a clock signal from an external device, and yellow if it can detect a signal at the wrong sample rate.

To change sample rate in OSX go to Audio MIDI Setup found by navigating to the folder:

Macintosh HD > Applications > Utilities > Audio MIDI Setup

Ensure that Audient iD24 is seen as an audio device (**Window Menu > Show Audio Window**).

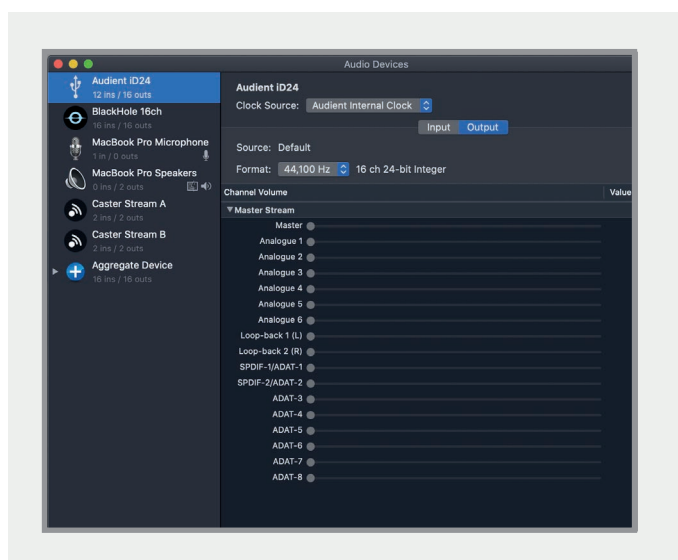

Double check that an appropriate clock source is selected (Internal for master operation), ADAT or S/PDIF clock for external slave operation. Ensure that you see the correct sample rate displayed in the Format drop-down menu.

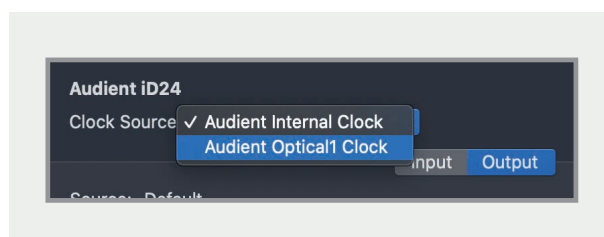

If you are using Windows, go to the iD icon in the system tray and right click on it. This will bring up some settings including sample rate. Alternatively you can alter these settings in the Setup tab of the iD app.

Change the sample rate to match that of the external ADAT device and session.

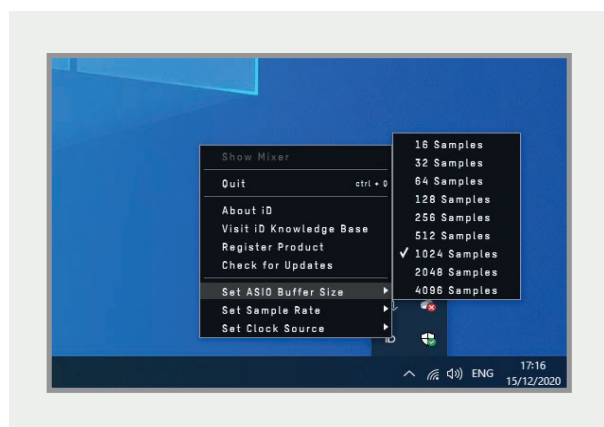

Troubleshooting

“How do I reset the iD mixer application to its default state?”

To reset the mixer application, quit the iD app completely, then navigate to the following folder and delete the state.xml file (it will replenish upon a fresh launch of the application):

Macintosh HD > User > Library > Application Support > Audient > iD > state.xml

(C:) > Users > yourusername > AppData > Roaming > Audient > iD > state.xml

Do not delete the parent folder as this will also contain your iD mixer presets.

“How do I make sure I have the latest version of iD firmware/software?”

To check for the latest updates to the iD desktop mixer application please visit:

audient.com/id24/downloads

download and install the latest driver.

You will be made aware of firmware releases from the iD app when connected to the internet. Please refer to earlier in this user manual for more information regarding firmware updates.

FAQs

For more information and bug support, please search our online Help Centre which can be found here:

support.audient.com

For technical support please create a ticket in our online support system, which can also be found in the support section of our website (see link above).

Technical Specifications



Line Inputs:

LINE GAIN:	-10 to +48dB
MAXIMUM INPUT LEVEL:	+22dBu
THD+N @0dBu 1kHz:	0.0013%, -97dB

D.I / Instrument Input:

D.I GAIN:	0 to 58dB
MAXIMUM INPUT LEVEL:	+12 dBu
THD+N @ 0dBu (1kHz):	0.0075%, -82dB
SNR:	95dB unweighted, 97.5dB A-weighted
FREQUENCY RESPONSE:	+/- 0.5dB 0.5dB 10Hz to 40kHz
INPUT IMPEDANCE:	500kΩ unbalanced
1/4" JACK:	TIP (Hot) & SLEEVE (Shield)

Analogue to Digital Converter:

MAXIMUM INPUT LEVEL:	12.5dBu=0dBFS
CROSSTALK:	@1k -135dB, @10k -125dB
FREQUENCY RESPONSE:	+/- 0.2dB 0.5dB 10Hz to Fs/2 (Nyquist)
THD+N @ -1dBFS (1kHz):	0.0004%, -108dB
DYNAMIC RANGE:	122dB A-weighted
INPUT IMPEDANCE:	>10kΩ
1/4" JACK:	TIP (Hot), RING (Cold) & SLEEVE (Shield)

Digital to Analogue Converter

MAXIMUM OUTPUT LEVEL:	12dBu=0dBFS
THD+N @ 1kHz -1dBFS:	0.0003%, -110dB
DYNAMIC RANGE:	126.5dB A-weighted
CROSSTALK:	-130dB @ 1kHz, -115dB @ 10kHz
FREQUENCY RESPONSE:	+/- 0.1dB 10Hz to Fs/2 (Nyquist)
OUTPUT IMPEDANCE:	<100Ω
1/4" JACK:	TIP (Hot), RING (Cold) & SLEEVE (Shield)

Word Clock Output:

WORD CLOCK:	44.1kHz to 96kHz
-------------	------------------

Microphone Preamplifier:

MIC GAIN:	0 to +58dB
MAXIMUM INPUT LEVEL:	+12dBu
CROSSTALK:	<-100dBu @ 1kHz & 10kHz
THD+N @0dBu 1kHz:	0.0015%, -96dB
MIC EIN:	-13dBu A-Weighted
CMRR	>75dB@1kHz
SNR:	97.5dB Unweighted, 100dB A-Weighted
FREQUENCY RESPONSE:	+/- 0.5dB 10Hz to 40kHz
INPUT IMPEDANCE (Mic)	3kΩ balanced
INPUT IMPEDANCE (Line)	10kΩ balanced
PAD:	-10dB
HPF CUTOFF FREQUENCY:	100Hz
PHANTOM POWER:	48V +/-4V @ 10mA/Channel
XLR COMBI FEMALE:	Pin 2 (Hot), Pin 3 (Cold) & Pin 1 (Shield)
1/4" TRS JACK:	TIP (Hot), RING (Cold) & SLEEVE (Shield)

Headphone Outputs:

MAXIMUM OUTPUT LEVEL:	18.5dBu=0dBFS
THD+N @ -1dBFS (1kHz):	0.0006%, -104dB
DYNAMIC RANGE:	124dB A-weighted
CROSSTALK:	-117dB @ 1kHz, -101dB @ 10kHz
FREQUENCY RESPONSE:	+/- 0.2dB 10Hz to Fs/2 (Nyquist)
OUTPUT IMPEDANCE:	<50Ω unbalanced
MAX LEVEL INTO 30R:	2.63V Peak, 1.87V RMS, 232mW
MAX LEVEL INTO 60R:	4.28V Peak, 3.03V RMS, 295mW
MAX LEVEL INTO 600R:	7.91V Peak, 5.6V RMS, 104mW

USB 2.0 High Speed:

NO. OF INPUT CHANNELS:	10 (2 Analogue, 8 Digital)
NO. OF OUTPUT CHANNELS:	14 (6 Analogue, 8 Digital)
CONNECTOR:	USB Type-C
INCLUDED CABLES:	1m USB 2.0 Type-C to Type-C

Digital Input:

8-CHANNEL ADAT:	44.1kHz to 48kHz
4-CHANNEL ADAT:	88.2kHz to 96kHz (SMUX)
STEREO S/PDIF	44.1kHz to 96kHz (Stereo)

Digital Output:

8-CHANNEL ADAT:	44.1kHz to 48kHz
4-CHANNEL ADAT:	88.2kHz to 96kHz (SMUX)
STEREO S/PDIF	44.1kHz to 96kHz (Stereo)

DSP Mixer Latency

Round Trip (in-to-out)

44.1kHz	0.344ms
48kHz	0.312ms
88.2kHz	0.188ms
96kHz	0.177ms

Dimensions

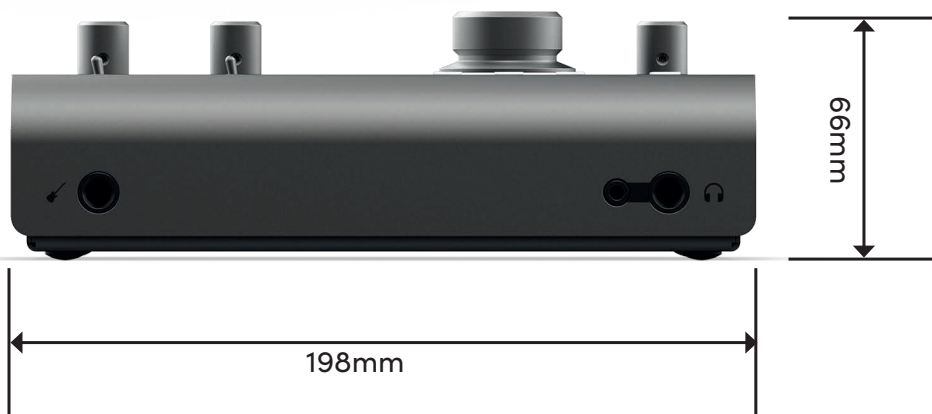

Warranty

Warranty Statement

Please read through this Limited Hardware Warranty before using Audient hardware.

Audient products are designed and built to the highest standards, using premium components designed to deliver years of reliable performance.

In the event of a manufacturing defect becoming apparent during the 3 year limited warranty period, Audient will ensure the product is repaired free of charge.

Audient are not liable for direct or consequential loss or damage resulting from the goods and/or their use.

Warranty Limitations

The Limited Warranty for any product purchased on or after February 01 2021 is for a period of 3 years from the original purchase.

Additionally, the 3-year Limited Warranty is retrospectively offered on any product purchased after February 01 2018.

Without exception you will need to provide a copy of your original dated invoice or store receipt identifying the product serial number as part of the consideration of the grant of warranty.

In the event that you are unable to provide proof of purchase, you should request a copy of your receipt from the reseller from whom you purchased the product.

For the full **'Terms and Conditions'** please head over <https://audient.com/warranty/>

Service

Service Information

iD24 contains no user-serviceable components, please refer to qualified service personnel for diagnosis and repair. Your warranty will be void if you tamper with the device at component level. If you have any questions with regard to the repair, please contact Audient Ltd.

If your unit is in warranty, please contact your dealer directly for a repair or replacement (at the discretion of the dealer).

For out of warranty repairs, please contact Audient Ltd, after which a **Return Materials Authorization** (RMA) number will be assigned. This number will serve as a reference for you and helps facilitate and expedite the return process. When the unit is returned please include this RMA number along with a description of the fault inside the packaging box.

To request an RMA, access technical support & FAQs, ask for troubleshooting assistance or make an enquiry, please visit: support.audient.com

Audient Ltd
Aspect House
Herriard
Hampshire
RG25 2PN
United Kingdom

Tel: +44 (0) 1256 381944
audient.com

Glossary

A	Amperes
ADAT	Alesis Digital Audio Tape
ADC	Analogue to Digital Converter
DAW	Digital Audio Workstation
ASP	Analogue Signal Processing
CPU	Central Processing Unit
CUE	Artist Headphone Mix
DAC	Digital to Analogue Converter
dB	Decibel
dBu	Decibel referenced to 0.775Vrms = 0 dBu
dBFS	Decibel Full Scale
DC	Direct Current
D.I	Direct Injection (Instrument Input)
DoC	Declaration of Conformity
DSP	Digital Signal Processing
EQ	Equaliser
FAQ	Frequently Asked Questions
FCC	Federal Communications Commission
GB	Gigabyte
GUI	Graphical User Interface
HPF	High Pass Filter
HV	High Voltage
i/o	Input / Output
JFET	Junction Field Effect Transistor
LED	Light Emitting Diode
RoHS	Restriction of Hazardous Substances
RAM	Random Access Memory
S/PDIF	Sony Philips Digital Interface Format
THD+N	Total Harmonic Distortion + Noise
TRS	Tip Ring Sleeve (1/4" Jack Balanced)
TS	Tip Sleeve (1/4" Jack Unbalanced)
USB	Universal Serial Bus
V	Volts
XLR	Extra Live Return, Extremely Low Resistance, Canon X Series, Latching, Resilient Rubber Compound... or make up your own!