

ZOOM®

V3

Vocal Processor

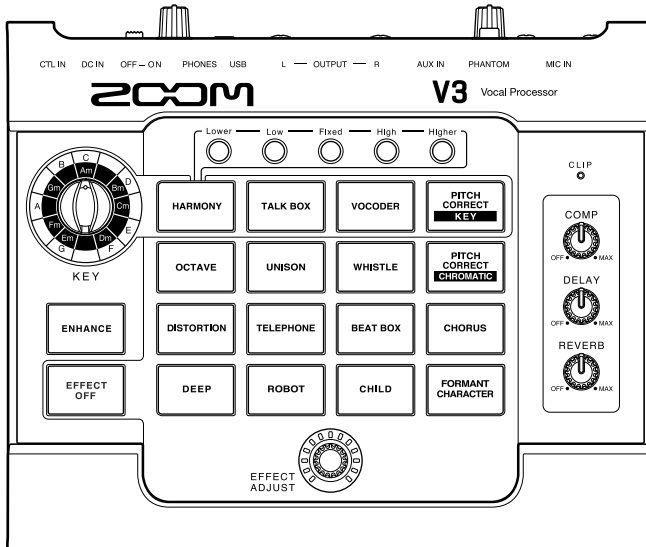

Operation Manual

You must read the Usage and Safety Precautions before use.



This Operation Manual can be downloaded from the ZOOM website (www.zoom.jp/docs/v3). This page has files in PDF and ePub formats.

The PDF file format is suitable for printing on paper and reading on a computer.

The ePub format can be read with electronic document readers and is designed for reading on smartphones and tablets.

© 2020 ZOOM CORPORATION

Copying or reprinting this manual in part or in whole without permission is prohibited.

Product names, registered trademarks and company names in this document are the property of their respective companies. All trademarks and registered trademarks in this document are for identification purposes only and are not intended to infringe on the copyrights of their respective owners.

You might need this manual in the future. Always keep it in a place where you can access it easily.

The contents of this manual and the specifications of the product could be changed without notice.

Introduction

Thank you very much for purchasing a ZOOM **V3** Vocal Processor.

The **V3** has numerous functions for transforming vocals. Anyone can use it to achieve powerful vocal sounds with simple operations.

This vocal processor is ideal for recording and live performance. After enhancing volume and clarity, it can correct pitch or add harmony and reverb, for example.

We hope you will enjoy using it for many years.

■ Main features of the V3

Compact form

We packed the functions that vocalists need most into a compact unit that is easy to carry around. You can use it on a table top or attached to a mic stand.

Easy sound creation

Creating sounds is as easy as turning knobs and pressing switches.

Singing assistance

The compressor evens out volume and the enhance function adds clarity to make singing easier.

Delay, reverb and other effects

The selection of 16 effects optimized for vocalists include semitone pitch correction and a harmonizer that can automatically generate 3rd and 5th harmonies in the set key, as well as a robotic sound and aggressive distortion.

Delay and reverb can be used simultaneously with another effect.

USB audio interface

The **V3** can be used as a 2-IN/2-OUT audio interface.

Contents

Introduction	2	Adjusting the volume and tone	9
V3 structure	3	Using effects	10
Names and functions of parts	4	Using audio interface functions	13
Making connections.....	6	Making unit settings.....	14
Loading batteries	8	Troubleshooting	15
Turning the power on	8	Specifications	16

V3 structure

■ Signal flow

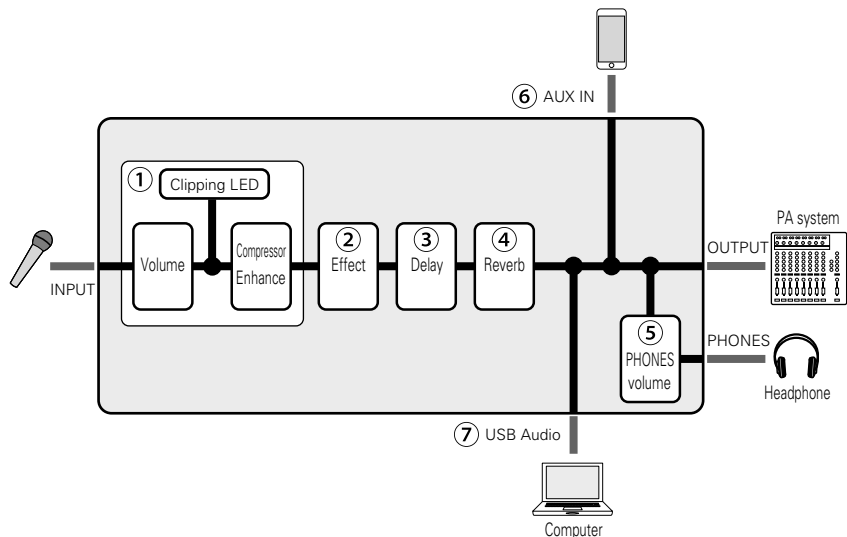

- ① Adjust the volume and tone of the mic input.
(→ “Adjusting the volume and tone” on page 9)
- ② Alter the voice or add harmony.
(→ “Using effects” on page 10)
- ③ Apply delay.
(→ “Adjusting the delay” on page 12)
- ④ Apply reverb.
(→ “Adjusting the reverb” on page 13)
- ⑤ Adjust the headphone volume.
(→ “Adjusting the volume and tone” on page 9)
- ⑥ Audio from smartphones, portable audio players and other devices can be input.
- ⑦ Audio data can be transferred to and from computers using the audio interface function.
(→ “Using audio interface functions” on page 13)

Names and functions of parts

■ Top

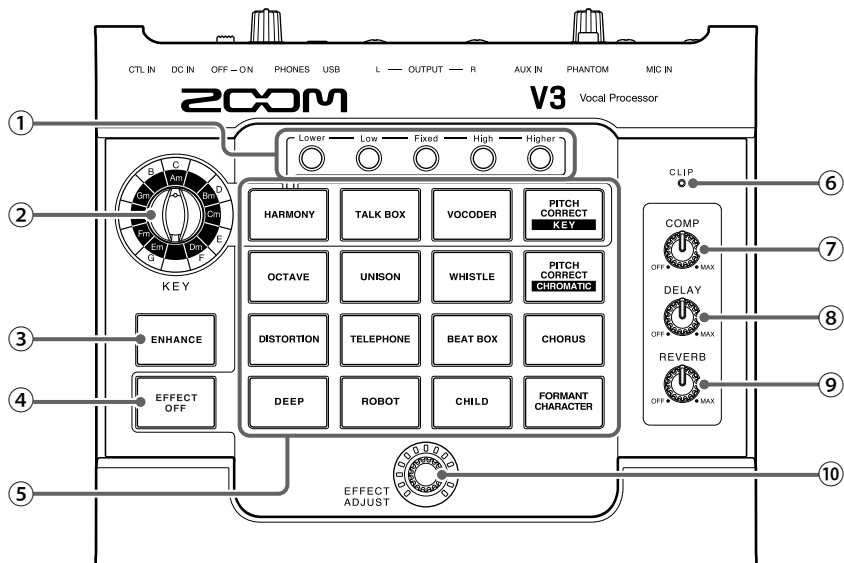

- ① **Harmony style buttons**
Press to activate harmony types.
- ② **KEY selection knob**
Select the key used for harmony and pitch correction.
- ③ **ENHANCE button**
Turn the ENHANCE function on/off.
- ④ **EFFECT OFF button**
This turns the effect off.
- ⑤ **Effect selection buttons**
Select from these 16 effect types.
- ⑥ **Clipping indicator**
This shows the input sound status, whether the power is on or off and the remaining battery charge.
- ⑦ **COMP knob**
Use to adjust the amount of compression.
- ⑧ **DELAY knob**
Use to adjust the amount of delay.
- ⑨ **REVERB knob**
Use to adjust the amount of reverb.
- ⑩ **EFFECT ADJUST knob**
Use to adjust the effect amount.

■ Back

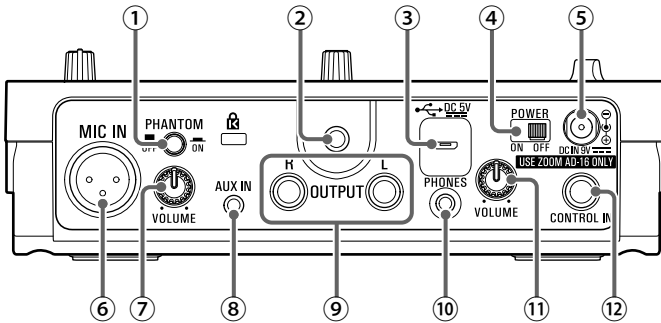

① PHANTOM switch

Turn +48 V phantom power ON/OFF.
Turn this ON when connecting a ZOOM SGV-6 mic or a condenser mic that requires phantom power, for example.

② Mounting accessory attachment threads

Use this to attach a mounting accessory (ZOOM HRM-7/HRM-11).

③ USB (Micro-B) port

A computer can be connected here. The **V3** can be used as an audio interface, and its firmware can be updated.
A mobile battery, for example, can also be connected here to provide power.

④ POWER switch

This turns the power on/off.

⑤ DC 9V AC adapter connector

Connect the dedicated AC adapter (ZOOM AD-16) here.

⑥ MIC IN jack

Connect a mic here.

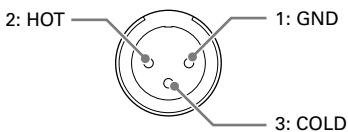

⑦ VOLUME knob

This adjusts the mic input volume.

⑧ AUX IN jack

A portable music player, for example, can be connected here.

⑨ OUTPUT jacks

Connect these to a mixer, PA system, recorder or other audio equipment that can adjust sound balance.
For mono use, connect the OUTPUT L jack.

⑩ PHONES jack

Connect headphones here.

⑪ PHONES VOLUME knob

Use to adjust the headphone volume.

⑫ CONTROL IN connector

An expression pedal (ZOOM FP02M) can be connected here to control the effect.
When a footswitch (ZOOM FS01) is connected, it can be pushed to turn the effect off.

Making connections

■ Connection examples

Mic (ZOOM SGV-6 or commercially-available mic)

Use a mic cable to connect it to the MIC IN jack.

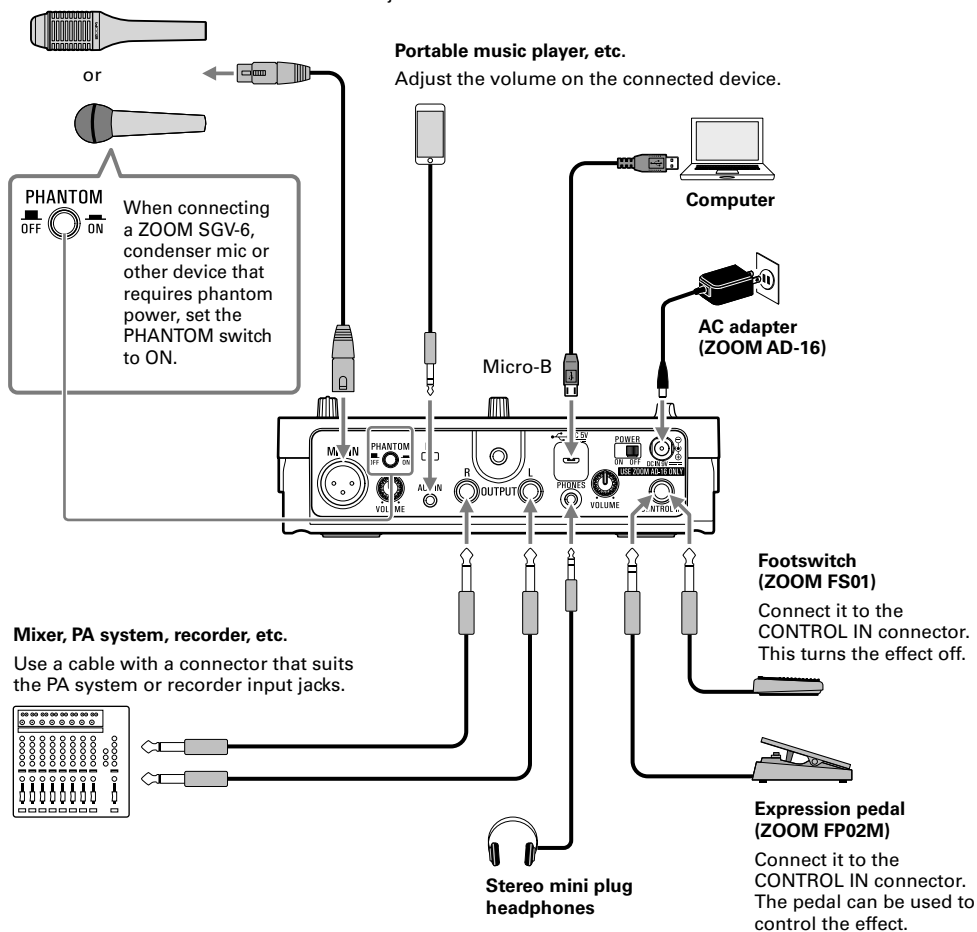

NOTE

Always set the PHANTOM switch to OFF when connecting a device that does not support phantom power. The device could be damaged if this is not done.

■ Example of use with a main mic and an effect mic

This example shows the use of a main mic for regular vocals and an effect mic passed through the **V3** just for phrases when pitch correction or a vocoder sound is desired.

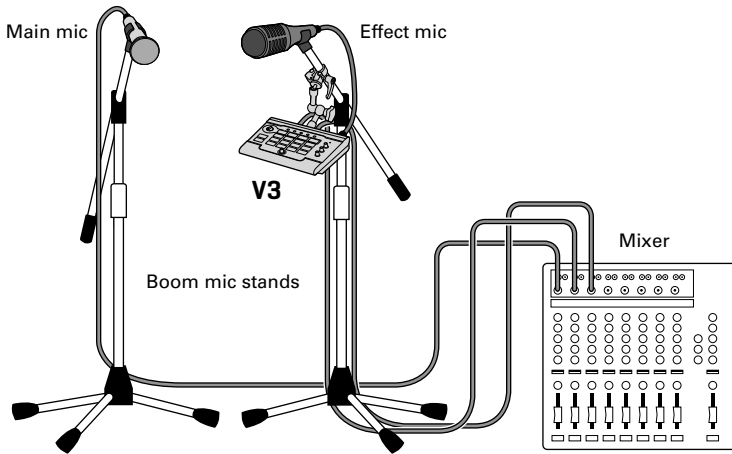

■ Attachment to boom mic stands

The **V3** can be attached to a boom mic stand by using a mounting accessory (ZOOM HRM-7/HRM-11).

1. Attach the mounting accessory to the mic stand boom.
3. Adjust the **V3** to the desired angle and secure the mounting accessory.

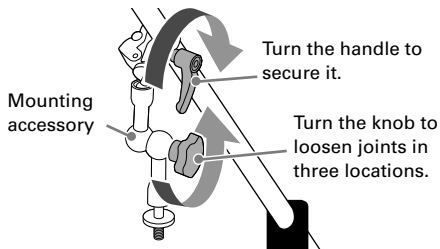

2. Attach the mounting accessory to the **V3**.

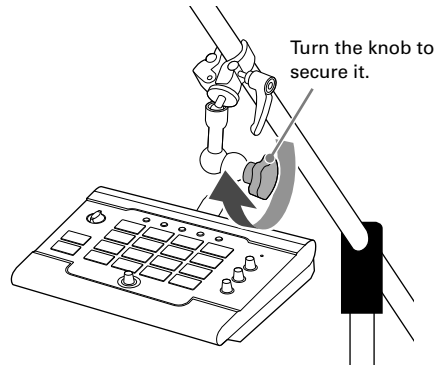
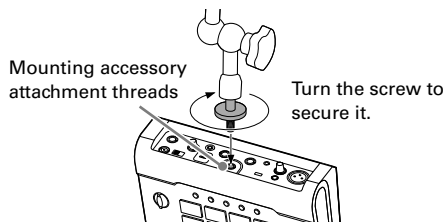

Loading batteries

Open the battery compartment cover on the bottom of the product and insert 4 AA batteries.

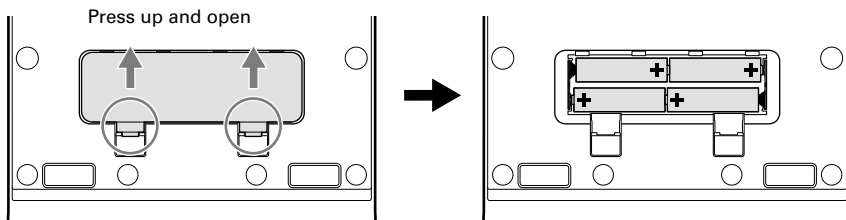

NOTE

- Set the type of battery used correctly so that the amount of remaining battery charge can be shown accurately. (→ "Making unit settings" on page 14)
- Whether or not there is input, when the remaining battery charge becomes low, ^{CLIP} will light red and then start blinking red. Replace the batteries with new ones.

HINT

Power for operation can also be supplied through the USB port.

Turning the power on

1. Minimize the volume of output devices.

2. Set  to ON.

This turns the **V3** power on, and ^{CLIP} lights green.

3. Raise the volume of output devices.

ECO mode overview

By default, the ECO mode setting is ON, so the power will automatically turn off if no use occurs for 10 hours. (→ "Making unit settings" on page 14)

Adjusting the volume and tone

■ Adjusting the mic input volume

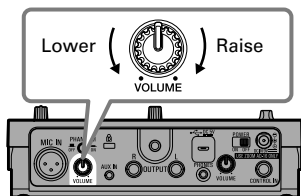

While singing, adjust it so ^{CLIP} lights green.

NOTE

Adjust the mic input volume to a level that enables the effect to function properly.

- CLIP
- Lit red: Volume too high
 - Lit green: Volume just right
 - Unlit: Volume too low

■ Reducing volume variation (compressor function)

Input sounds over a certain level can be compressed to lower their volume and even out the overall volume.

1. Turn  .

Turn it right to increase the effect. Turn it completely left to turn the compressor function off.

Compressor function use

If a single song contains both shouting or other loud singing and quiet whisper-like singing, for example, matching the level to the loud singing will cause the quiet singing to become inaudible. Compressing the volume of loud singing to reduce overall volume differences makes quiet singing easier to hear.

■ Bringing out vocal character (enhance function)

1. Press  so that it lights.

This turns the enhance function on.

The enhance function has two effects

- **Clarifying the voice:** By emphasizing high frequencies, this can make singing clearer, so that it is not lost in the sound of a band.
- **Suppressing "s" and other sibilant sounds:** These are "s" sounds and other sounds produced through gaps in the teeth when singing. Suppressing sibilant sounds that become distracting when the mic volume is turned up can make voices sound pleasanter.

■ Adjusting headphone volume

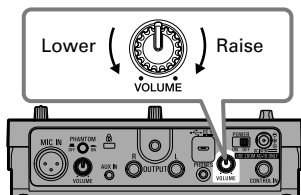

Using effects

The voice can be altered with pitch correction, pitch shifting or a vocoder effect, for example. Harmony can also be generated automatically according to the key setting. Furthermore, the altered voice and harmony can be further affected by delay and reverb, for example.

Select the key used for harmony and pitch correction.

Use these to generate harmonies automatically according to the key setting.

→ “Setting the HARMONY key and pitches” on page 12

These can alter the sound of the voice. For example, they can correct pitch according to the key or make the voice sound childlike, vocoded or distorted.

→ “Altering vocals” on page 10

This turns the effect off.

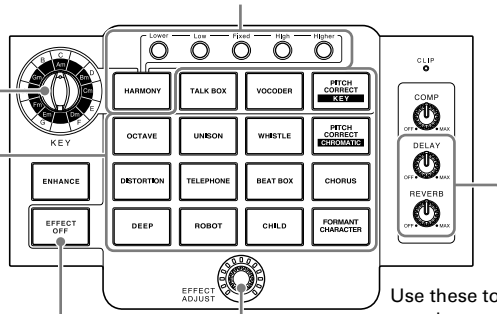

Adjust the effect amount.

Use these to add delay and reverb to vocal sounds after the selectable effect.

→ “Adding delay and reverb” on page 12

NOTE

After effects are adjusted, their states are saved individually.

■ Altering vocals

1. Press an effect selection button.

The pressed button lights and its effect is selected.

2. Turn .

This adjusts the effect.

Button	Explanation	Adjustment
HARMONY**	This generates harmony automatically according to the set key.* Set the harmony intervals generated using the harmony style buttons.	Balances original and harmony sounds
TALK BOX**	This creates a talk box sound effect. This corrects the pitch to the set key.* TALK BOX pitch correction follows a blue note scale and adds a $\flat 3$ to major scales and a $\flat 5$ to natural minor scales.	Pitch correction amount

Button	Explanation	Adjustment
VOCODER**	This creates a vocoder sound effect. This corrects the pitch to the set key.*	Pitch correction amount and octave setting
PITCH CORRECT KEY**	This corrects the pitch to the set key.* This can be adjusted from a gentle pitch correction to a mechanical effect that changes the pitch in steps.	Pitch correction amount
OCTAVE	This doubles the voice one octave down/up.	Balances original and effect sounds
UNISON	This creates an effect like singing the same part twice by duplicating the sound with the pitch and timing slightly shifted.	Effect mix level
WHISTLE	This has the effect of sounding like whistling even when just singing.	Amount of original sound in mix/whistle octave
PITCH CORRECT CHROMATIC**	This corrects the pitch to semitones. This can be adjusted from a gentle pitch correction to a mechanical effect that changes the pitch in steps. We recommend this setting when a song is in an unknown key or it has numerous key changes.	Pitch correction amount
DISTORTION	This distorts the voice heavily.	Distortion amount
TELEPHONE	This emulates a retro-sounding telephone.	Frequency band affected
BEAT BOX	This adds impact for beat boxing.	Boost amount
CHORUS	This chorus is full and gentle.	Effect mix level
DEEP	This makes the voice low-pitched and deep by lowering the pitch and changing the character greatly.	Voice character
ROBOT**	This makes the voice sound robotic.	Pitch of the robot voice sound
CHILD	This makes the voice high-pitched and childlike by raising the pitch and changing the character greatly.	Voice character
FORMANT CHARACTER	This changes the character of the voice without changing the pitch.	Voice character The original voice is restored when the EFFECT ADJUST knob is at its center position.

* For details about setting the key, see step 1 of “Setting the HARMONY key and pitches” on page 12.

**This follows the standard pitch setting (“Making unit settings” on page 14).

HINT

If an expression pedal (ZOOM FP02M) is connected, it can be used to adjust the effect (same as using ). If a footswitch (ZOOM FS01) is connected, it can be used to turn the selected effect off.

■ Setting the HARMONY key and pitches

When the HARMONY effect is selected, two of the five options can be selected to generate harmonies automatically based on the KEY setting.

1. Turn .

This sets the key.

When using sheet music, the key can be determined from the key signature.

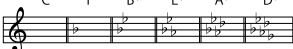
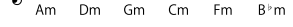
Major key 
 Minor key 

Major key 
 Minor key 

What is a key?

A key is a musical scale of 7 notes used in a song. Keys that sound bright are known as major keys and keys that sound dark are known as minor keys. The first note in the scale gives the key its name (A–G). For example, the bright-sounding scale that begins with C (Do) and has the seven notes C, D, E, F, G, A and B (Do, Re, Mi, Fa, Sol, La and Ti) is called the C major key. Likewise, the dark-sounding scale that contains the same notes, but begins with A (La) is the A minor (Am) key.

2. Press , , , or .

Press  repeatedly to cycle through volume levels: high → medium → low → off. The brightness changes with the level. Up to two harmony options can be activated. Activating a third harmony option will cancel the first one activated.

Harmony	Harmony pitch generated
Higher	+5 or +6 degrees
High	+3 or +4 degrees
Fixed	The note of the key selected in step 1 (fixed)
Low	-3 or -4 degrees
Lower	-5 or -6 degrees

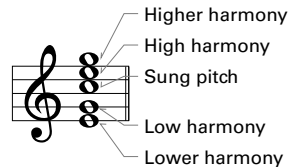

Harmonies are generated automatically according to the key.

Pitches added with the HARMONY function

“Degrees” are the number of steps in the scale from the fundamental pitch of the key. For example, when “Higher” is activated, Harmony will automatically be generated +5 or +6 degrees above the sung pitch.

-8 -7 -6 -5 -4 -3 -2 Root +2 +3 +4 +5 +6 +7 +8
 Do Re Mi Fa Sol La Ti  Re Mi Fa Sol La Ti Do

■ Adding delay and reverb

Adjusting the delay

This creates an effect like an echo.

1. Turn .

Turn it right to increase the effect. Turn it completely left to turn the delay effect off.

Adjusting the reverb

Adding reverberations gives the sound width and depth.

1. Turn  .

Turn it right to increase the effect. Turn it completely left to turn the reverb effect off.

Using audio interface functions

■ Installing the driver

Windows

1. Download the ZOOM V3 Driver from www.zoom.co.jp to the computer.

The latest ZOOM V3 Driver can be downloaded from the above website.
Download the driver for the operating system being used.

2. Launch the installer and follow the instructions to install the ZOOM V3 Driver.

See the Installation Guide included in the driver package for detailed installation procedures.
If the power supplied by the USB bus is low, or you want to operate the unit with an adapter, use the dedicated AC adapter (ZOOM AD-16).

Mac computers and iOS/iPadOS devices

A driver is not necessary when using a Mac or iOS/iPadOS device.

■ Connecting to a computer or iOS/iPadOS device

1. Use a USB cable to connect the **V3** with the computer or iOS/iPadOS device.

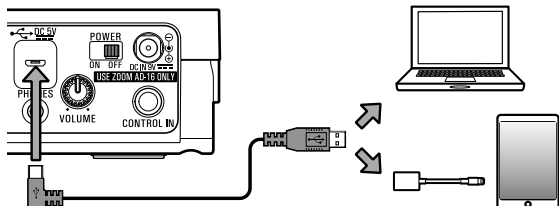

NOTE

When connecting to an iOS/iPadOS device, use a Lightning to USB camera adapter (or Lightning to USB 3 camera adapter).

2. Set  to ON.

Turn the **V3** on and connect the iOS/iPadOS device.
If connecting to a computer, continue with step 3.

3. When connecting a computer, set the **V3** as the sound device.

Making unit settings

See the table below for setting items and values.

1. While pressing and holding ,  or , set  to ON.

The pressed button will blink.





2. Turn .

The lit LED position shows the setting value.

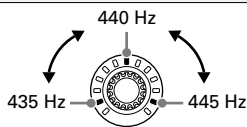

3. Press the blinking button.

This saves the setting, and restarts the **V3**.

Pressing a button that is not blinking will cancel the setting.

Setting item and button pressed at startup	Setting range	Explanation
Standard pitch adjustment 	 This can be adjusted in 1 Hz intervals.	This adjusts the standard pitch used for correcting vocal pitch and adding harmony. Note: The pitch used for "A" (La) is expressed in hertz (Hz). Vocal and harmony pitches can be matched to the instruments being played together by setting the standard pitch used by the V3 to the same pitch.
Battery setting 	 Alkaline batteries Lithium batteries	Set the type of battery used correctly so that the amount of remaining battery charge can be shown accurately.
ECO mode setting 	 Off On	This function can be used to turn the power off automatically if unused for 10 hours.

Restoring factory default settings

1. While pressing and holding , set  to ON.

The pressed button will blink.

2. Press .

This restores factory default settings and restarts the **V3**. Pressing anything other than  will cancel initialization.

Initialization will overwrite all settings to their factory defaults. Be certain before using this function.

Troubleshooting

The unit will not power on

- Confirm that the POWER switch is set to ON. (→ “Turning the power on” on page 8)
- Confirm that the AC adapter is connected correctly. (→ “Making connections” on page 6)
- If using batteries, confirm that they are installed correctly. (→ “Loading batteries” on page 8)
- Replace the batteries with new ones. (→ “Loading batteries” on page 8)

There is no sound or output is very quiet

- Check the connections. (→ “Making connections” on page 6)
- Raise the volume of output devices.
- If using headphones, raise the headphone volume. (→ “Adjusting headphone volume” on page 9)

There is a lot of noise

- Confirm that the mic cable is not the cause.
- Use a genuine ZOOM AC adapter. (→ “Making connections” on page 6)

The sound distorts strangely or has an odd timbre

- Adjust the input volume to a suitable level. (→ “Adjusting the mic input volume” on page 9)
- Adjust the amount of compression. (→ “Reducing volume variation (compressor function)” on page 9)

The effect is not working

- Adjust the EFFECT ADJUST knob. (→ “Using effects” on page 10)
- Confirm that the effect is not turned off. (→ “Using effects” on page 10)

Batteries lose their charge quickly

- Confirm that you are not using manganese batteries. Alkaline batteries should provide about 3.5 hours of continuous operation.
- Confirm the battery setting.
The setting must match the batteries being used in order to show the remaining battery charge accurately. (→ “Making unit settings” on page 14)
- Due to battery characteristics, they discharge more quickly when used in places with low temperatures.

V3 is not recognized by a computer, smartphone or tablet connected using a USB cable

- Check OS compatibility on the ZOOM website (www.zoom.co.jp).
- Confirm that the cable being used is not designed only for charging.

- Windows[®] is a trademark or registered trademark of Microsoft[®] Corporation.
- Mac and iPadOS are trademarks or registered trademarks of Apple Inc.
- iOS is a trademark or registered trademark of Cisco Systems, Inc. and used under license.
- Other product names, registered trademarks and company names in this document are the property of their respective companies.

Note: All trademarks and registered trademarks in this document are for identification purposes only and are not intended to infringe on the copyrights of their respective owners.

Specifications

Simultaneous effects	5 types (compressor, enhance, selectable effect, delay, and reverb)	
Selectable effects	16 types (HARMONY, VOCODER, TALK BOX, PITCH CORRECT-KEY, OCTAVE, UNISON, WHISTLE, PITCH CORRECT-CHROMATIC, DISTORTION, TELEPHONE, BEAT BOX, CHORUS, CHILD, ROBOT, DEEP, FORMANT CHARACTER)	
Sampling frequency	44.1 kHz	
A/D conversion	24-bit 128× oversampling	
D/A conversion	24-bit 128× oversampling	
Signal processing	32-bit	
Frequency response	20 Hz – 20 kHz (+1 dB/–3 dB) (10 kΩ load)	
Inputs	MIC IN	XLR jack Input gain: +3 – 40 dB Maximum input level: +4 dBu Input impedance: 3 kΩ or more Phantom power: +48 V
	AUX IN	Stereo mini jack Rated input level: –10 dBu Input impedance (line): 22 kΩ
Outputs	L/R	Standard mono phone jack Maximum output level: +6 dBu Output impedance: 100 Ω
	PHONES	Stereo mini jack Maximum output: 20 mW + 20 mW (into 32 Ω load)
Equivalent input noise (when phantom power off)	–125 dBu or less (A-weighted, 150 Ω input, +40 dB input gain)	
Control input	FS01/FP02M input	
Power	AC adapter: 9V DC 500 mA center negative (ZOOM AD-16) 4 AA batteries (about 3.5 hours continuous operation time when using alkaline batteries)	
USB	Port and supported cable type: USB 2.0 Micro-B Audio interface: USB 2.0 Full Speed, 44.1 kHz, 16/24/32-bit, 2 in, 2 out <ul style="list-style-type: none"> • Use a USB cable that supports data transfer. • Power can also be supplied through the USB port. • When using a cable designed only for power, other USB functions cannot be used. 	
External dimensions	150 mm (D) × 190 mm (W) × 50 mm (H)	
Weight	0.59 kg (excluding batteries)	

Note: 0 dBu = 0.775 V



ZOOM CORPORATION

4-4-3 Kanda-surugadai, Chiyoda-ku, Tokyo 101-0062 Japan

www.zoom.co.jp