

M2

MicTrak

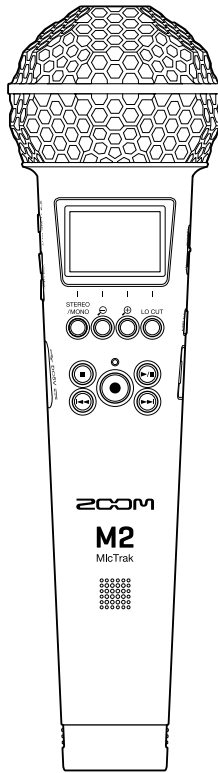

Operation Manual

You must read the Usage and Safety Precautions before use.

©2022 ZOOM CORPORATION

Copying or reprinting this manual in part or in whole without permission is prohibited.

Product names, registered trademarks and company names in this document are the property of their respective companies. All trademarks and registered trademarks in this document are for identification purposes only and are not intended to infringe on the copyrights of their respective owners.

Proper display is not possible on grayscale devices.

Notes about this Operation Manual

You might need this manual in the future. Always keep it in a place where you can access it easily. The contents of this document and the specifications of the product could be changed without notice.

- Windows® is a trademark or registered trademark of Microsoft® Corporation.
- Mac, macOS and iPadOS are registered trademarks of Apple Inc. in the USA and other countries
- iOS is a trademark or registered trademark of Cisco Systems, Inc. in the USA and other countries, and it is used under license.
- Android is a trademark of Google LLC.
- The microSDXC logo is a trademark of SD-3C LLC.
- Recording from copyrighted sources, including CDs, records, tapes, live performances, video works and broadcasts, without permission of the copyright holder for any purpose other than personal use is prohibited by law. ZOOM CORPORATION will not assume any responsibility related to infringements of copyrights.

Contents

Notes about this Operation Manual.....	2
M2 overview.....	5
Realizing high audio quality throughout recording and editing.....	5
Functions of parts.....	9
Overview of main screens.....	13
Recording process.....	21
Making preparations.....	22
Inserting microSD cards.....	22
Supplying power.....	23
Using the mic holder.....	26
Turning the power on/off.....	27
Setting the language shown (first time starting up).....	28
Setting the date format (first time starting up).....	29
Setting the date and time (first time starting up).....	30
Setting the type of batteries used (first time starting up).....	31
Preventing misoperation (hold function).....	32
Making input settings.....	33
Changing the stereo/mono setting.....	33
Reducing noise (low-frequency cut).....	34
Recording.....	35
Adjusting the volume display size to make checking easier.....	35
Monitoring input and playback sounds.....	36
Making recording settings.....	37
Recording.....	41
Adding marks during recording.....	42
Playing recordings.....	43
Playing recordings.....	43
Adding/deleting marks during playback.....	46
Using automatic playback volume adjustment.....	47
Managing files.....	48
M2 folder and file structure.....	48
Checking files (FILE LIST Screen).....	51
Deleting files.....	53
Optimizing file volume (normalization).....	55
Changing bit depth and exporting files (Export).....	56
Checking file information.....	58
Using as a USB mic.....	59
Installing drivers.....	59
Connecting computers, smartphones and tablets.....	60
USB mic muting.....	62

Disconnecting from computers, smartphones and tablets.....	63
Making USB mic settings.....	64
Transferring files to computers and other devices.....	68
Connecting computers, smartphones and tablets.....	68
Disconnecting from computers, smartphones and tablets.....	70
Making various settings.....	71
Setting the language shown.....	71
Setting the date and time.....	72
Setting the date format.....	74
Setting the display backlight.....	76
Setting the display contrast.....	78
Setting the type of batteries used.....	79
Setting the time until the power turns off automatically (Auto Power Off).....	81
Managing microSD cards.....	83
Formatting microSD cards.....	83
Testing microSD cards.....	84
Restoring factory default settings.....	88
Managing the firmware.....	89
Checking the firmware versions.....	89
Updating the firmware.....	89
Appendix.....	90
Troubleshooting.....	90
Specifications.....	92

M2 overview

Realizing high audio quality throughout recording and editing

With dual A/D converter circuits and support for 32-bit float WAV files, the M2 can maintain the highest audio quality from recording to post-production.

Recording

Dual AD converter circuits enable recording from quiet to loud volumes without any need to make gain adjustments.



Post-production

Recording with 32-bit float WAV file format allows the recording audio quality to be retained when editing.



Dual A/D converter circuit overview

For each input circuit, the M2 has two A/D converters with different input gains. This design enables high-quality audio recording without the need to adjust gain settings, a step that normally had been indispensable.

Providing amazing dynamic range

By combining two A/D converters, a wide dynamic range not possible with a single A/D converter has been realized.

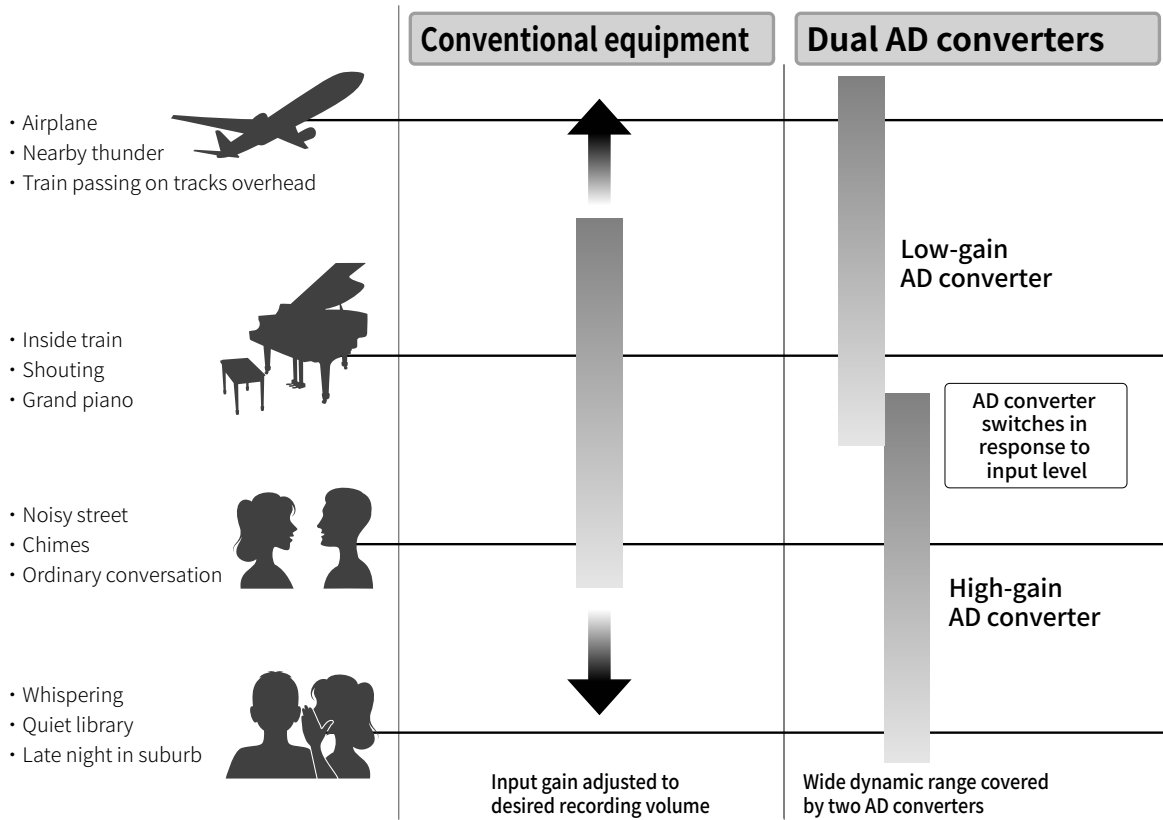

Switching between two A/D converters

The M2 constantly monitors data from the two A/D converters and automatically selects the one that provides the best recording results.

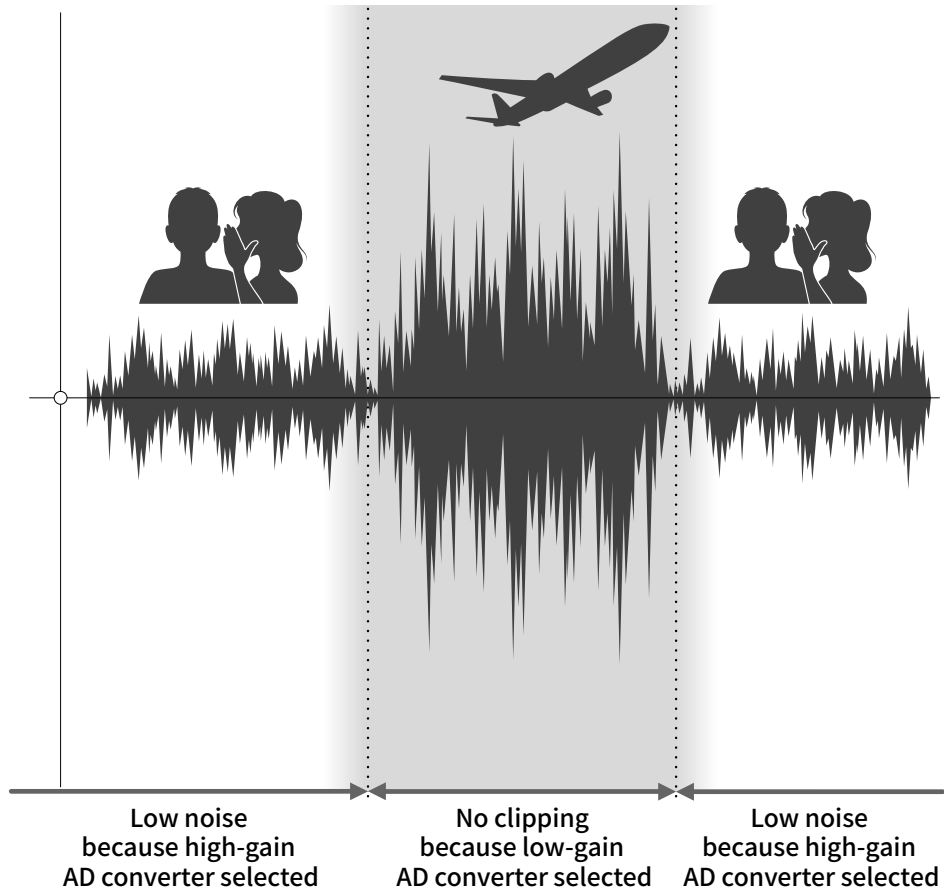

32-bit float WAV file overview

32-bit float WAV files have the following advantages over conventional 16/24-bit WAV files.

These features enable the quality of the sound during recording to be maintained even during post-production.

Resolution advantage

32-bit float WAV files have the advantage of being able to maintain high resolution even at low volumes. As a result, quiet sounds can be made louder when editing after recording without degrading their quality.

■ 16/24-bit WAV



■ 32-bit float WAV



Clipping advantage

If a waveform sounds clipped when output from the M2 or in a DAW, it can be edited after recording to lower its volume and restore an unclipped waveform because the data in the 32-bit float WAV file itself is not clipped.

■ 16/24-bit WAV

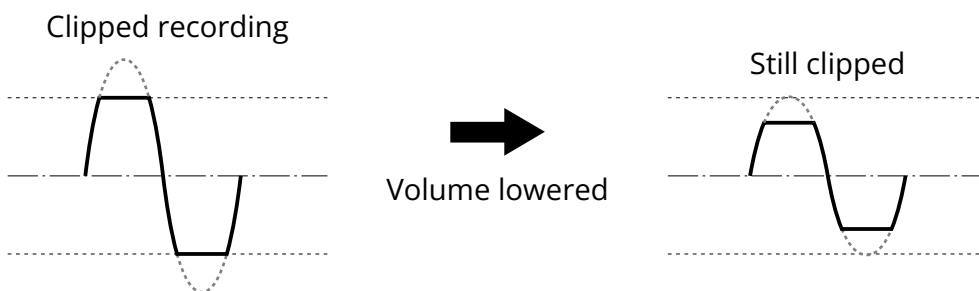

■ 32-bit float WAV

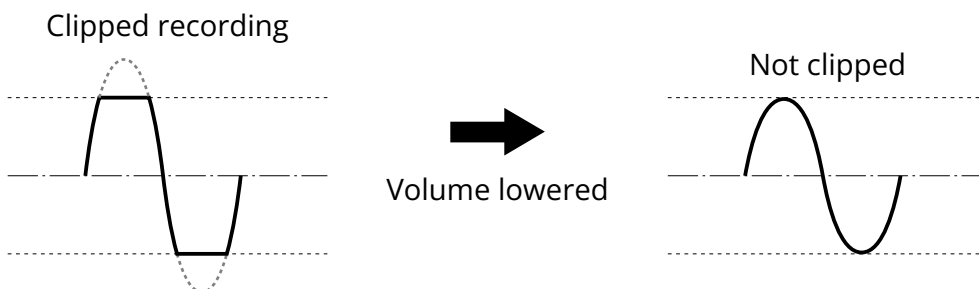

Functions of parts

Front/back

■ Front

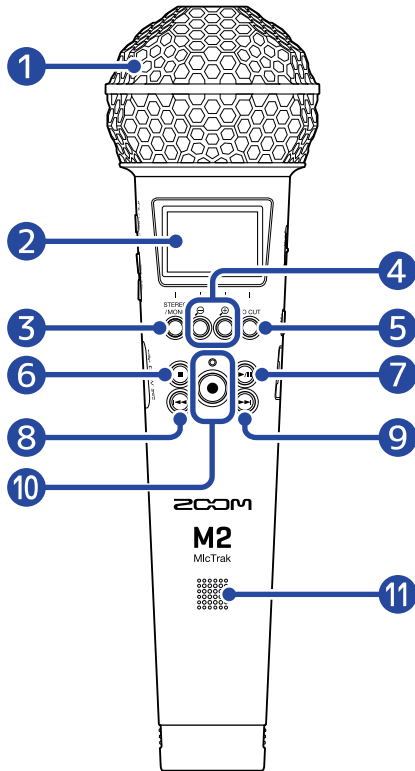

■ Back

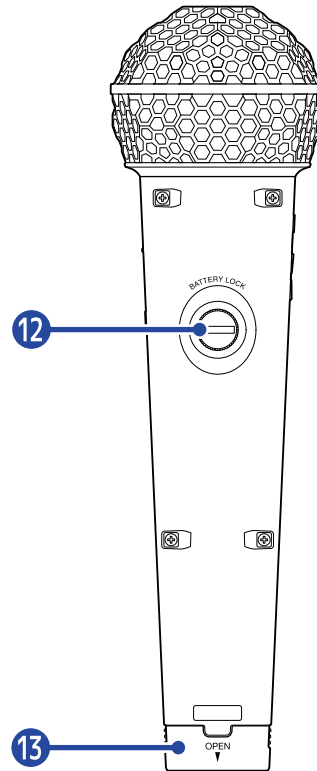

1 Built-in XY mic

This stereo mic has two crossing directional mics. This mic can record three-dimensional sound with natural depth and width.

2 Display

This shows various types of information.

3 STEREO/MONO/operation button

Home Screen: Switch the recording audio format between stereo and mono.

Other screens: Use operation shown by icon at bottom of screen. (→ [Operation button overview](#))

4 /Operation buttons

Home Screen: Change volume amplification on the display

Other screens: Use operation shown by icon at bottom of screen. (→ [Operation button overview](#))

5 LO CUT/operation button

Home Screen: Change LO CUT setting

Other screens: Use operation shown by icon at bottom of screen. (→ [Operation button overview](#))

6 STOP button

This stops recording and playback.

Press this when playing or paused to close the Playback Screen and open the Home Screen.

7 **PLAY/PAUSE button**

This starts and pauses playback.

When used as a USB mic, this mutes/unmutes it.

8 **REW button**

When playing or paused, this will move to the file before the current one, the beginning of the current file, or the mark before the current position.

Press and hold to search backward.

9 **FF button**

When playing or paused, this will move to the file or mark after the current one.

Press and hold to search forward.

10 **REC button/indicator**

This starts recording. The REC indicator lights during recording.

Press when recording or playing to add a mark at that point.

11 **Speaker**

Sound is output here during file playback.

If headphones, for example, are connected to the PHONE/LINE OUT jack, audio will not be output from the speaker.

12 **Battery compartment locking screw**

Use this when installing and removing the battery compartment. (→ [Installing batteries](#))

13 **Battery compartment**

Install batteries here.

To remove the battery compartment, loosen the battery compartment locking screw. (→ [Installing batteries](#))

■ Operation button overview

When operation icons are shown at the bottom of the Menu Screen and Playback Screen, for example, use the corresponding operation buttons (which are right below the icons) to select and confirm items on the screen.

■ Menu Screen example

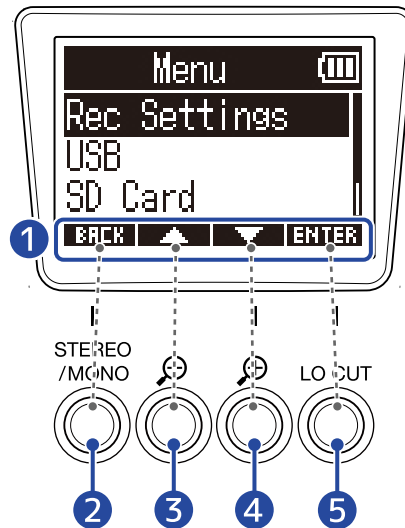

1 Operation icons

The icons shown depend on the screen.

2 Operation button (**BACK**)

Reopen the previous screen.

3 Operation button (**▲**)

Select the item above.

4 Operation button (**▼**)

Select the item below.

5 Operation button (**ENTER**)

Confirm the selected item.

Other operation icons will also be shown. See the explanations of procedures for each item for details.

■ Abbreviation of procedures in this operation manual

In this operation manual, procedures that involve pressing operation buttons are shown with icons in the following manner.

Example: Use the buttons that correspond to **▲** and **▼** to select "Rec Settings". Then, use the button that corresponds to **ENTER** to confirm the selected item.

→ Use **▲** / **▼** to select "Rec Settings" and press **ENTER** to confirm.

■ Left and right sides

■ Left side

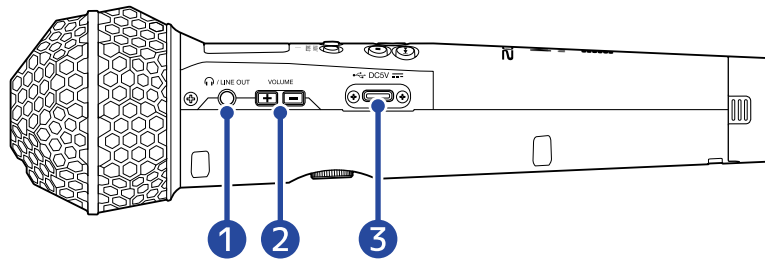

■ Right side

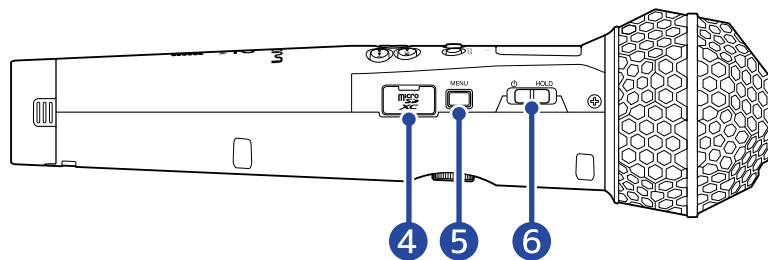

1 PHONE/LINE OUT jack

This stereo mini jack can be used to output sound to headphones or another device.

2 VOLUME buttons

Use these to adjust the volume of the headphone/built-in speaker.

3 USB port (Type-C)

Connect this to a computer, smartphone or tablet to use this mic as an SD card reader or USB mic. This supports operation on USB bus power.

4 microSD card slot

Insert a microSD card here.

5 MENU button

This opens the Menu Screen and returns to the Home Screen.

6 POWER/HOLD switch

Use this to turn the power on/off and to disable button operation.

Overview of main screens

This section explains the screens that are shown on the M2 display.

Home Screen

This appears on the display when the M2 power is turned on. This shows the state of the M2, including the recording status and the waveforms of input signals.

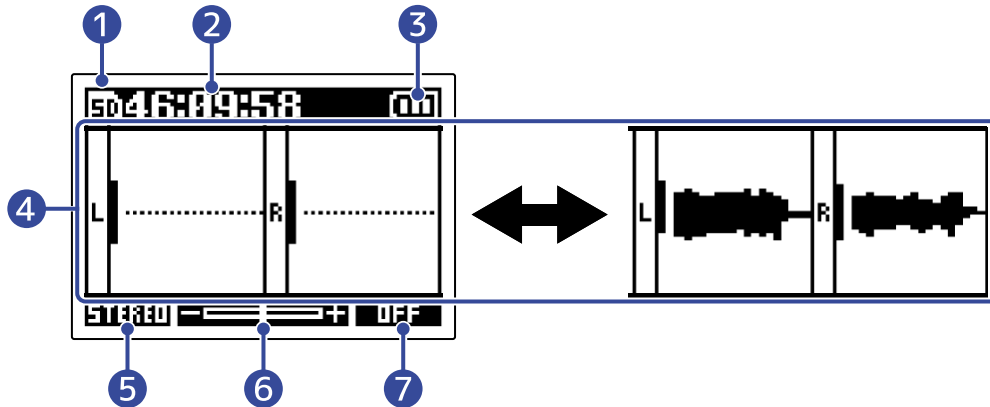

1 Status icon

This icon shows the recording status.

-  Stopped
-  Recording

2 Counter

This shows the available recording time when standing by and the current elapsed recording time when recording.

3 Remaining battery charge indicator

This is shown when batteries are being used for operation. When the remaining battery charge becomes low, replace the batteries (→ [Installing batteries](#)), or connect an AC adapter (→ [Connecting an AC adapter](#)) or portable battery (→ [Using other power sources](#)).



4 Volume/waveform display

This shows the volumes of the signals input to the M2. Waveforms appear during recording.

(→ [Adjusting the volume display size to make checking easier](#))

Inputs are shown on the left edge of each volume display.

- L: Built-in XY mic left signal
- R: Built-in XY mic right signal

5 Stereo/mono setting

This shows the current recording format. When STEREO, stereo audio will be recorded. When MONO, left and right channels will be mixed together and recorded as mono audio. (→ [Changing the stereo/mono setting](#))

6 Volume amplification on the display



This shows the amount that the volume is amplified on the display.

Adjust this as necessary so that the volume shown is easy to check. (→ [Adjusting the volume display size to make checking easier](#))

7 LO CUT setting

This shows the LO CUT setting. (→ [Reducing noise \(low-frequency cut\)](#))

HINT:

- When a screen other than the Home Screen is open, pressing  will open the Home Screen. This function is useful for returning quickly to the Home Screen from various setting screens. (Returning directly to the Home Screen is not possible from a few screens.)
 - When the [Playback Screen](#) or [FILE LIST Screen](#) is open,  can be pressed to open the Home Screen.
-

Playback Screen



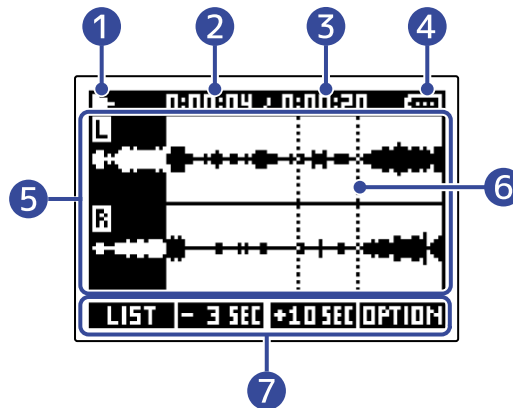

When the [Home Screen](#) is open, pressing  to start playback will also open this screen.

This screen shows the M2 playback status, including the playback time and recording file waveform.



1 Status icon

Icons shows the playback status.

-  Playing back
-  Paused
-  Searching backward
-  Searching forward

2 Playback time

This shows the time elapsed since the start of playback.

3 File length

This shows the length of the file that is currently playing.

4 Remaining battery charge indicator

This is shown when batteries are being used for operation. When the remaining battery charge becomes low, replace the batteries (→ [Installing batteries](#)), or connect an AC adapter (→ [Connecting an AC adapter](#)) or portable battery (→ [Using other power sources](#)).



Full ←————→ Empty

5 Waveform display

This shows the waveforms of the recorded files being played.

The color is inverted for parts of waveforms that have already been played.

Mark positions can also be checked. (→ [Adding marks during recording](#), [Adding/deleting marks during playback](#))

6 Mark bar

Bars show marks added to the file that is playing back.

7 Operation icons

By pressing the operation buttons below the corresponding operation icons on the display, the playback position can be skipped and the screen can be changed. The file can also be deleted or exported and information about it can be checked. (→ [Operation button overview](#))

HINT:

- Press  to stop playback and reopen the Home Screen.
 - Press **LIST** to open the [FILE LIST Screen](#).
-

FILE LIST Screen



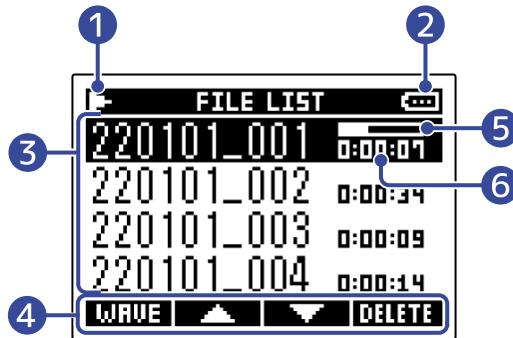

Press **LIST** when the [Playback Screen](#) is open to open this screen.

The files on the microSD card will be shown in a list on the display, so the content of the card can be checked and files can be played and deleted, for example.



1 Status icon

Icons shows the playback status.

-  Playing back
-  Paused
-  Searching backward
-  Searching forward

2 Remaining battery charge indicator

This is shown when batteries are being used for operation. When the remaining battery charge becomes low, replace the batteries (→ [Installing batteries](#)), or connect an AC adapter (→ [Connecting an AC adapter](#)) or portable battery (→ [Using other power sources](#)).



Full ← → Empty

3 File list

This list shows the files on the microSD card.

The names and lengths of files are shown. A progress bar is shown for the selected file.

When the list has more files than will fit on the display, a scrollbar will appear on the right edge.

4 Operation icons

Files can be selected and deleted by pressing the operation buttons below the corresponding operation icons on the display. The screen can also be switched. (→ [Operation button overview](#))



5 Progress bar

This shows the current playback position.

6 Playback time/file length

When playing or paused, this shows the elapsed time from the start of playback. When stopped, this shows the file length.

HINT:

- Press  to stop playback and reopen the Home Screen.
 - Press  to open the [Playback Screen](#).
-

Menu Screen

Use the Menu Screen to make various settings, including recording and hardware settings.

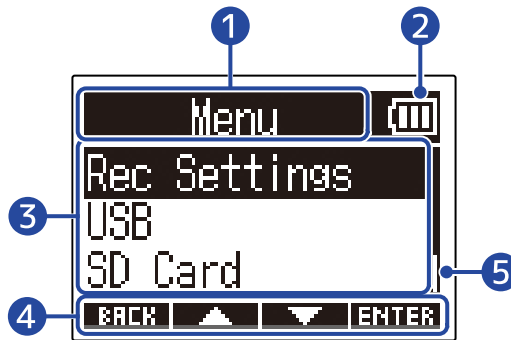

1 Menu title

2 Menu items

These include setting items and setting values.

3 Operation icons

By pressing the operation buttons below the corresponding operation icons on the display, menu items can be selected and selected items can be confirmed. (→ [Operation button overview](#))

4 Remaining battery charge indicator

This is shown when batteries are being used for operation. When the remaining battery charge becomes low, replace the batteries (→ [Installing batteries](#)), or connect an AC adapter (→ [Connecting an AC adapter](#)) or portable battery (→ [Using other power sources](#)).



5 Scrollbar

This will appear when the list has more items than will fit on the display.

Opening the Menu Screen

1. Press .

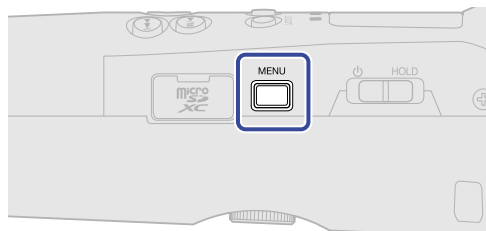

HINT:

When a screen other than the Home Screen is open, pressing  will open the Home Screen. This function is useful for returning quickly to the Home Screen from various setting screens. (Returning directly to the Home Screen is not possible from a few screens.)



Recording process

Recording follows the process shown below.

Preparation before recording

- Insert a microSD card (→ [Inserting microSD cards](#))
- Supply power (→ [Installing batteries](#) / → [Connecting an AC adapter](#))
- Turn the power on (→ [Turning the power on](#))
- Make settings related to input (→ [Making input settings](#))
- Make settings related to recording (→ [Making recording settings](#))

Recording

- Use  to start recording and  to stop it (→ [Recording](#))

Playing back and reviewing

- Use  to start playback and  to stop it (→ [Playing recordings](#))

Making preparations

Inserting microSD cards

1. When the power is off, open the microSD card slot cover, and insert a microSD card all the way into the slot with the pins facing up.

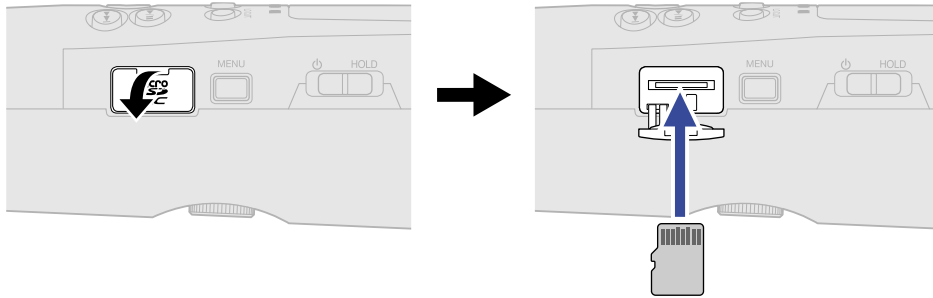

To remove a microSD card, push it further into the slot and then pull it out.

2. Close the microSD card cover.

NOTE:

- Always make certain that the power is off when inserting or removing a microSD card. Inserting or removing a card while the power is on could result in data loss.
- When inserting a microSD card, be sure to insert the correct end with the correct facing.
- Recording and playback are not possible when a microSD card is not loaded in the M2.
- Always format microSD cards in order to maximize their performance after purchasing them new or using them with a different device. (→ [Formatting microSD cards](#))

Supplying power

The M2 can be powered by batteries or a power supply connected to the USB port (AC adapter, USB bus power or portable battery).

When a power supply is connected to the USB port, it will be used before the batteries.

Installing batteries

Use 2 AA batteries to power the M2 with batteries.

1. After turning the power off, loosen the battery compartment locking screw, and remove the battery case from the M2.

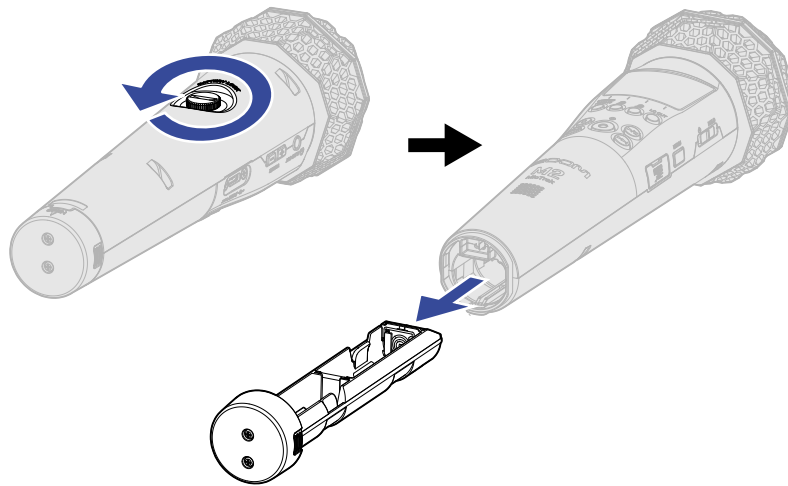

2. Put 2 AA batteries into the battery case.

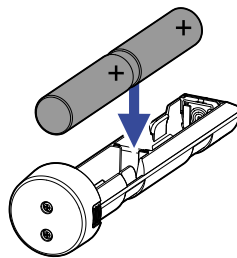

3. Insert the battery case into the M2, and tighten the battery compartment locking screw.

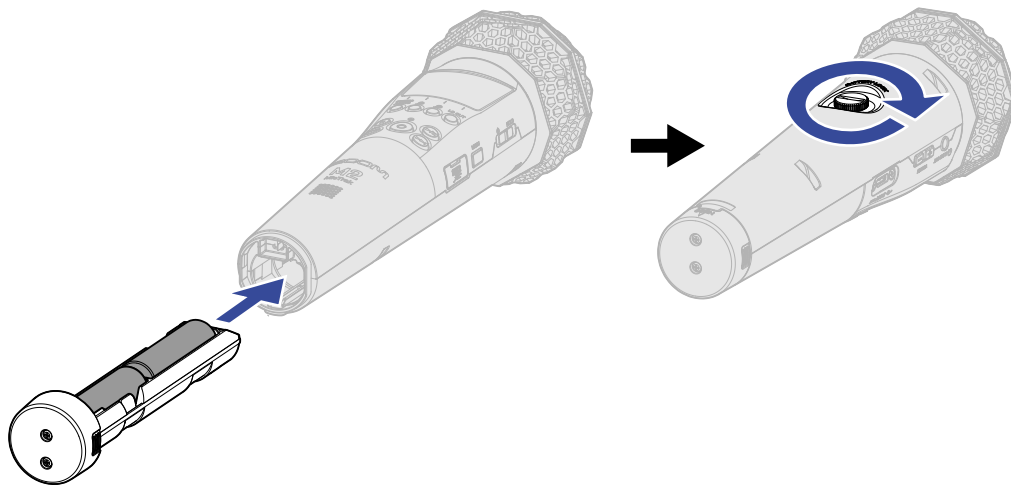

NOTE:

- Use only one type of battery (alkaline, NiMH or lithium) at a time.
- Set the type of battery used correctly so that the amount of remaining battery charge can be shown accurately. (→ [Setting the type of batteries used](#))
- If the batteries run out of power, turn the power off immediately and install new batteries. The remaining battery power will usually be shown when using battery power (except for some screens).

Connecting an AC adapter

Connect the cable of the dedicated AC adapter (AD-17) to the USB port (Type-C), and connect the adapter to an outlet.

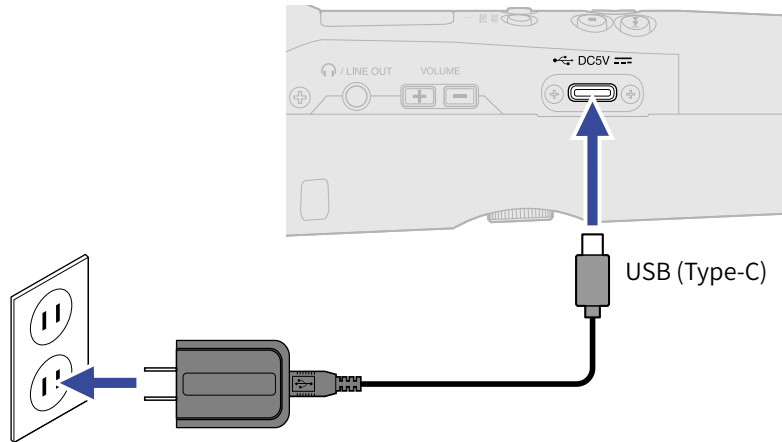

Using other power sources

By connecting a computer to the USB port (Type-C), the M2 can be operated using USB bus power. In addition, a 5V portable battery (commercially-available) can also be used for power.

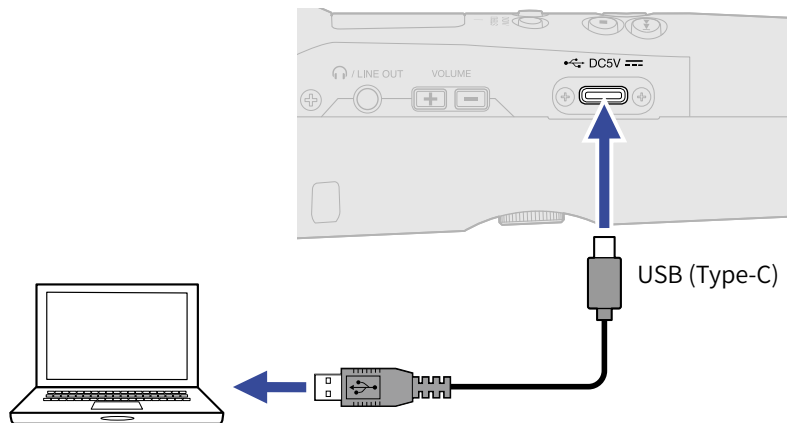

Using the mic holder

To use the M2 on a mic stand, for example, mount it in the included mic holder.

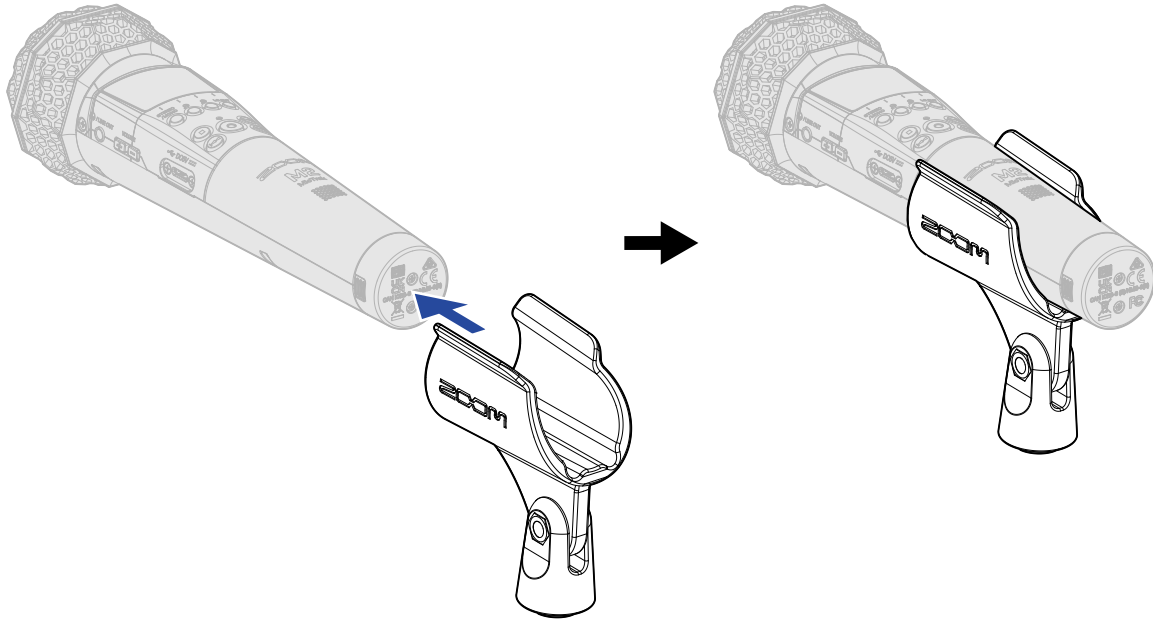

Turning the power on/off

Turning the power on

1. Slide  toward .

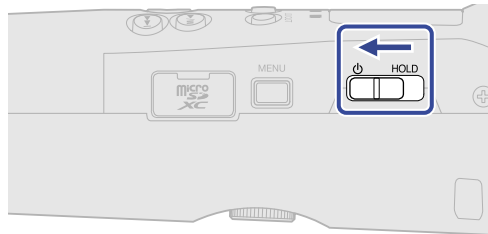

This turns the M2 power on and opens the Home Screen on the display (→ [Home Screen](#)).

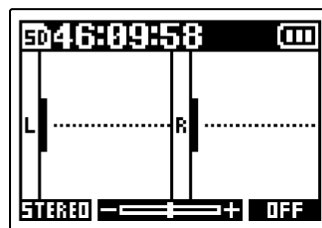

The first time the power is turned on immediately after purchase as well as after restoring the M2 to its factory default state, screens for setting the display language and date and time will appear on the display, so make these settings. (→ [Setting the language shown \(first time starting up\)](#), [Setting the date format \(first time starting up\)](#), [Setting the date and time \(first time starting up\)](#), [Setting the type of batteries used \(first time starting up\)](#))

NOTE:

- The M2 can be set to automatically turn off if it is not used for a specific amount of time. (→ [Setting the time until the power turns off automatically \(Auto Power Off\)](#))
- If “No SD Card!” appears on the display, confirm that a microSD card is inserted properly. (→ [Inserting microSD cards](#))
- If “Invalid SD Card!” appears on the display, the card is not formatted correctly. Format the microSD card or use a different microSD card. (→ [Formatting microSD cards](#), [Inserting microSD cards](#))

Turning the power off

1. Slide  toward  until “Goodbye! See You!” appears on the display.

The display will become empty and the power will turn off.

NOTE:

When the power is turned off, “Saving settings” will appear and the current settings will be saved in the M2. When “Saving settings” is shown, do not interrupt the power by disconnecting the AC adapter or removing the batteries, for example.

Setting the language shown (first time starting up)

The first time the power is turned on after purchase, set the display language when the Language Setting Screen opens.

1. Use  and  to select the display language, and press  to confirm.



This will confirm the language shown on the display, and open a screen to set the date format, so set the format. (→ [Setting the date format \(first time starting up\)](#))



HINT:

The display language setting can also be changed later from the Menu Screen. (→ [Setting the language shown](#))

Setting the date format (first time starting up)

The first time the power is turned on after purchase, after the display language is set, the date format settings screen will be shown on the display, so set it.

The date written in recording files will be in the format selected here.

1. Use  and  to select the date format, and press  to confirm.

The current set date will be shown at the bottom of the screen as a concrete example of the date format set.

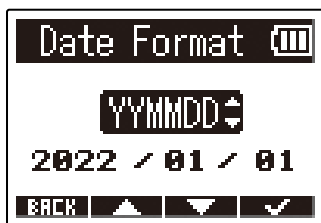

Setting	Explanation
YYMMDD	The date is shown in year, month, day order.
MMDDYY	The date is shown in month, day, year order.
DDMMYY	The date is shown in day, month, year order.



After setting the date format, a screen to set the date and time will open, so set the date and time. (→ [Setting the date and time \(first time starting up\)](#))

HINT:



The Date Format setting can also be changed later from the Menu Screen. (→ [Setting the date format](#))

Setting the date and time (first time starting up)

The first time the power is turned on after purchase, after the date format is set, the date and time settings screen will be shown on the display, so set them. The date and time are written to recording files.

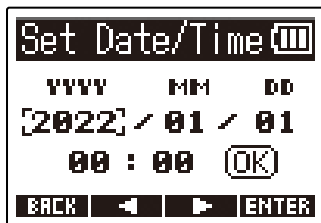
1. Use  and  to select the item to set, and press **ENTER** to confirm.



2. Use  and  to change the value, and press  to confirm.

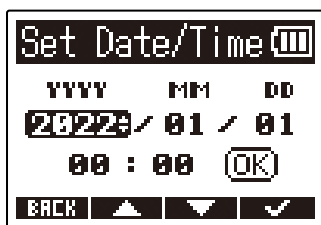

3. Repeat steps 1-2 to set the date and time.

4. After setting all items, use  and  to select **(OK)**, and press  to confirm.

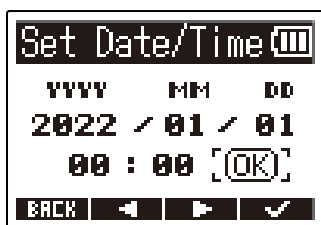

After confirming the date and time, a screen to set the battery type will open, so set it. (→ [Setting the type of batteries used \(first time starting up\)](#))

NOTE:



If power is not supplied for a long time, the date and time settings stored in the mic will be reset. If the Set Date/Time Screen appears during startup, set them again.

HINT:

The date and time setting can also be changed later from the Menu Screen. (→ [Setting the date and time](#))

Setting the type of batteries used (first time starting up)

The first time the power is turned on after purchase, after the date and time are set, the battery type setting screen will be shown on the display. Select correctly the type of batteries used in the M2 so that the remaining battery charge can be shown accurately on the display.

1. Use  and  to select the battery type, and press  to confirm.

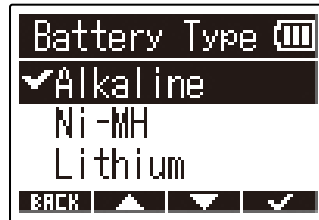

Setting	Explanation
Alkaline	Alkaline batteries
Ni-MH	Nickel-metal hydride batteries
Lithium	Lithium batteries

HINT:

The battery type setting can also be changed later from the Menu Screen. (→ [Setting the type of batteries used](#))

Preventing misoperation (hold function)

In order to prevent misoperation, the hold function can be used to disable the buttons on the M2.

1. Slide  to HOLD.

This turns on the hold function, disabling all button operations.

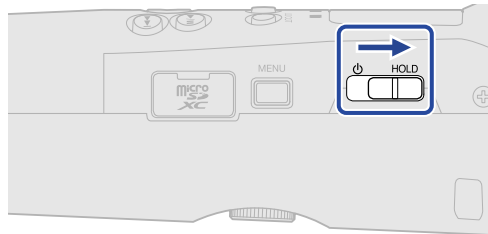

To disable the hold function, slide  back to the center position.

Making input settings

Changing the stereo/mono setting

The channel format used for recorded audio can be set.

When "STEREO", left and right channels will be recorded together as stereo audio. When "MONO", left and right channels will be mixed together and recorded as mono audio.

1. Press  when the Home Screen is open.

Pressing this switches between STEREO and MONO.

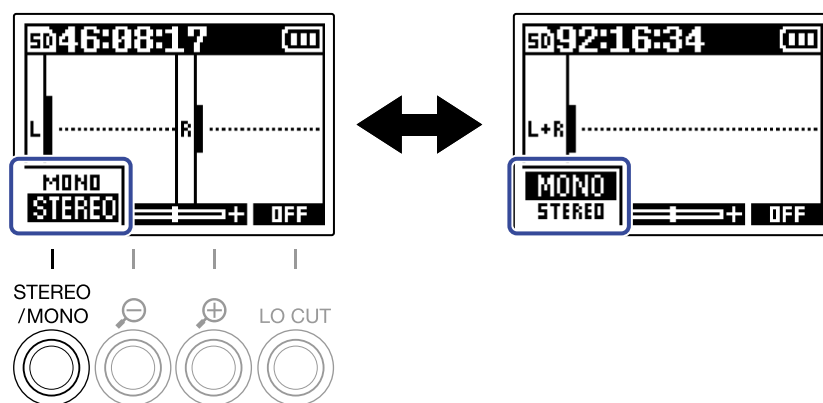

The set channel format is shown on the Home Screen.

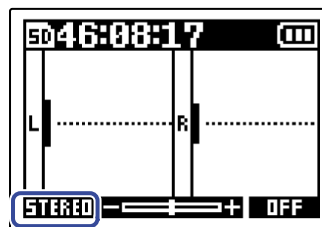

NOTE:

Sound output from the PHONE/LINE OUT jack and sound from USB mic operation can be switched in the same way.

Reducing noise (low-frequency cut)

Low frequencies can be cut to reduce the sound of wind and vocal pop noises, for example.

1. On the Home Screen, press  repeatedly to set the cutoff frequency.

The selected frequency is shown on the Home Screen.

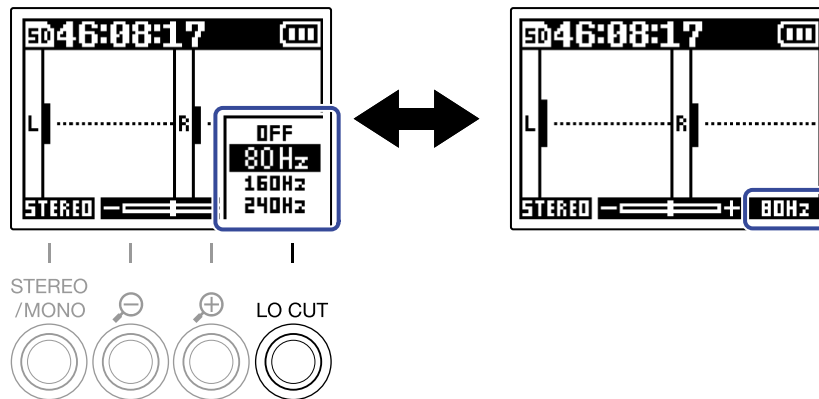

LO CUT can be set to OFF, 80Hz, 160Hz or 240Hz.

HINT:

We recommend using a windscreen (included) if air is blown directly at the mic, for example, when recording outdoors or when the mic is near the mouth of a speaker.

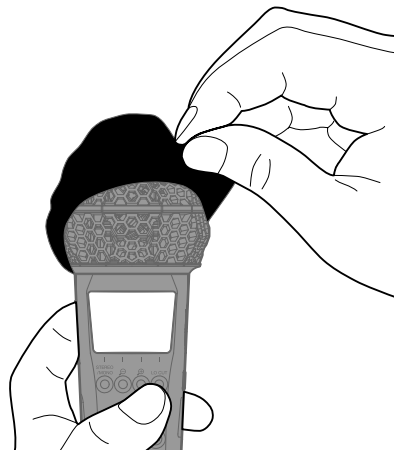



Recording

Adjusting the volume display size to make checking easier

The M2 records using 32-bit float format, making input gain adjustments unnecessary. Depending on the input signal, however, the volume shown on the display could be too small or too large, making it difficult to check.

By changing volume amplifications shown on the display, sizes can be adjusted to make checking easier. Moreover, the sizes of waveforms shown during recording also change recorded volumes.

1. Use  and  to adjust the size to make the volume easy to check.

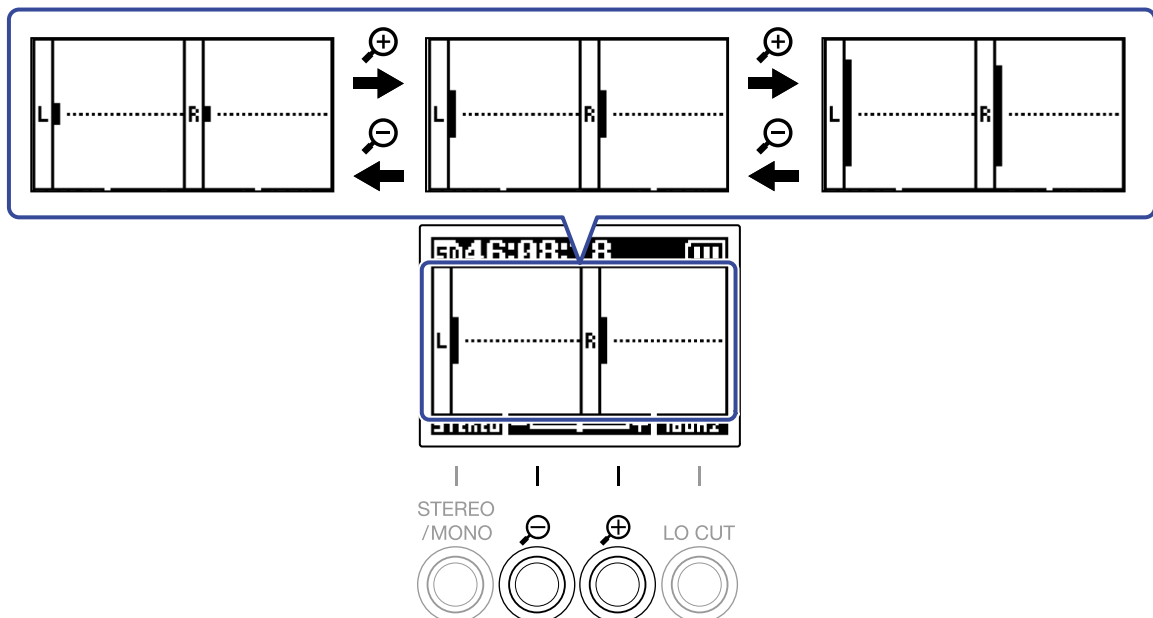

The amplification can be checked with  below the waveform.

NOTE:

- The waveform display size can be adjusted to 11 levels.
- Be careful with the volume if you are monitoring the input sound with headphones, for example.
- Adjusting the amplification during recording will not affect the recording level of that recording.

Monitoring input and playback sounds

Input and playback sounds can be monitored using headphones, for example, and the monitoring volume can be adjusted.

1. Connect headphones, for example, to the PHONE/LINE OUT jack.

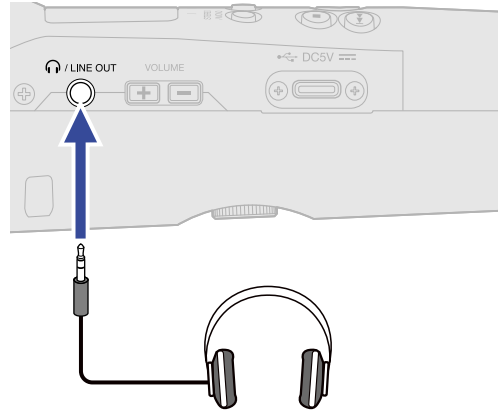

2. Use  to adjust the volume of the headphones or other connected device. The volume will be shown on the display while it is being adjusted.

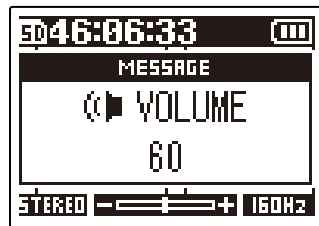

NOTE:

- The volume output from the PHONE/LINE OUT jack will be affected by changing the volume amplification on the display. (→ [Adjusting the volume display size to make checking easier](#))
- When nothing is connected to the PHONE/LINE OUT jack, using  will change the volume of the built-in speaker.
- The built-in speaker cannot be used for monitoring while recording.

HINT:

- Adjust the volume after adjusting the volume amplification on the display. (→ [Adjusting the volume display size to make checking easier](#))
- Battery operation time can be lengthened by disconnecting headphones from the PHONE/LINE OUT jack when headphone monitoring is not needed.
- The volume can be adjusted separately for the speaker and headphones.

Making recording settings

Setting the sample rate

The sampling rate used to record files can be set.

1. Press .

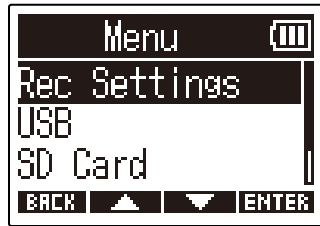

This opens the Menu Screen.

2. Use  and  to select "Rec Settings" and press  to confirm.

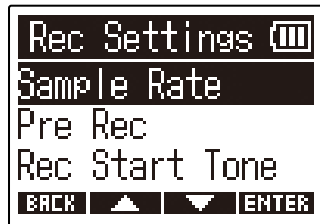

3. Use  and  to select "Sample Rate" and press  to confirm.



4. Use  and  to select the sample rate and press  to confirm.

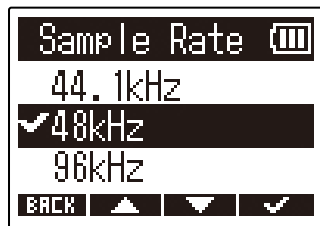

The following sample rates can be selected.

44.1 kHz, 48 kHz, 96 kHz

NOTE:

The bit depth used for recording is always 32-bit float.

Capturing audio before recording starts (pre-recording)



The input signal is always buffered for a set amount of time, so it can be captured for 2 seconds before  is used to start recording (pre-recording).

This is useful when  is used late, for example.

1. Press  when the Home Screen is open.
This opens the Menu Screen.

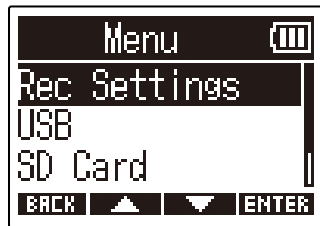
2. Use  and  to select "Rec Settings" and press  to confirm.



3. Use  and  to select "Pre Rec" and press  to confirm.

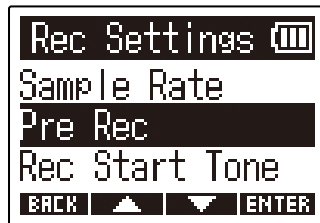

4. Use  and  to select "On" and press  to confirm.

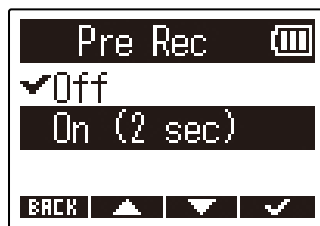

Setting the recording start tone

Half-second tone signals (recording start tones) can be output from the PHONE/LINE OUT jack when recording starts.

Since recording start tones are also written to recording files, when recording audio for video with the M2, sending its output signal to the camera input can make synchronizing audio and video easier.

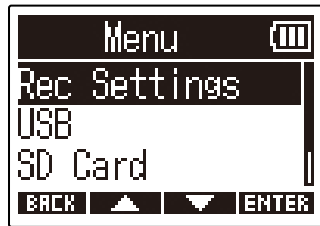

1. Press  when the Home Screen is open.
This opens the Menu Screen.

2. Use  and  to select "Rec Settings" and press  to confirm.

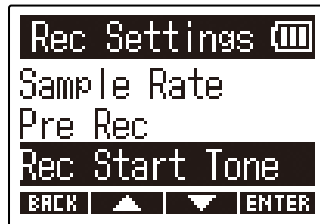

3. Use  and  to select "Rec Start Tone" and press  to confirm.



4. Use  and  to select "On" and press  to confirm.

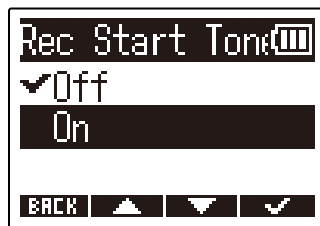

5. Use a stereo minijack cable to connect the camera input jack and the M2 PHONE/LINE OUT jack.

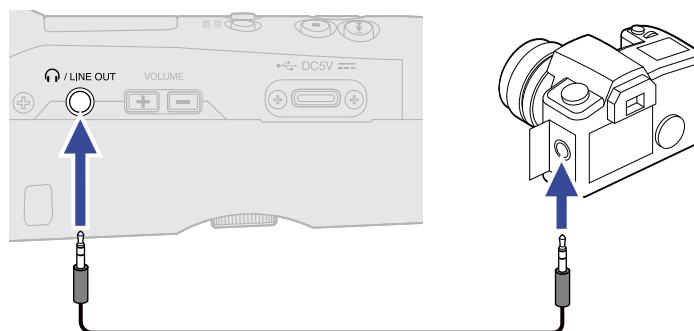

NOTE:

Be careful with the volume when monitoring the input sound with headphones connected to the camera, for example.

Recording

1. Press  when the Home Screen is open.



The REC indicator will light red, recording will start and the name of the file being recorded will be shown on the display.

The elapsed recording time is shown while recording.

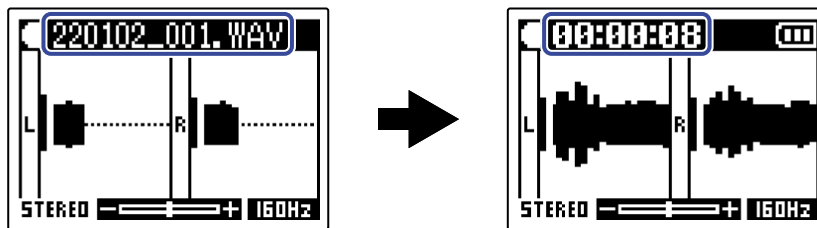

2. Press  to stop.

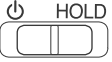
Sliding  toward HOLD can prevent misoperation when recording. (→ [Preventing misoperation \(hold function\)](#))

NOTE:



If the file size exceeds 2 GB when recording, a new file will be created automatically and recording will continue without pause. No gap in sound will occur between the two files when this happens.

HINT:

- Marks can be added during recording by pressing . (→ [Adding marks during recording](#))
A maximum of 99 marks can be added in a file.
- Files are automatically saved at set intervals while recording. If the power is interrupted or another problem occurs while recording, an affected file can be restored to normal by playing it with the M2.

Adding marks during recording

Marks can be added to a file while it is being recorded.

Added marks are shown on the [Playback Screen](#) where  and  can be used to move the playback position between them.

1. Press  while recording.

This adds a mark at the position of the current elapsed recording time.





NOTE:

- Up to 99 marks can be added to a single file.
- Marks can be deleted on the [Playback Screen](#). (→ [Deleting marks](#))

Playing recordings

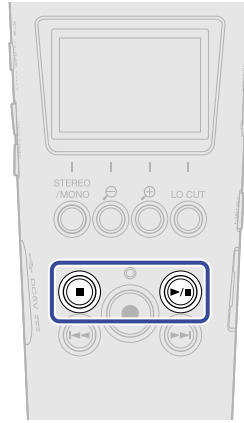
Playing recordings



1. Press  when the Home Screen is open.
This opens the [Playback Screen](#) on the display and starts playback.



See "[Playback Screen operations](#)" for details about operations when the Playback Screen is open.

NOTE:

The M2 cannot play files that it did not record or files that have been edited elsewhere after recording.





HINT:

Use the FILE LIST Screen to select files for playback. (→ [Checking files \(FILE LIST Screen\)](#))

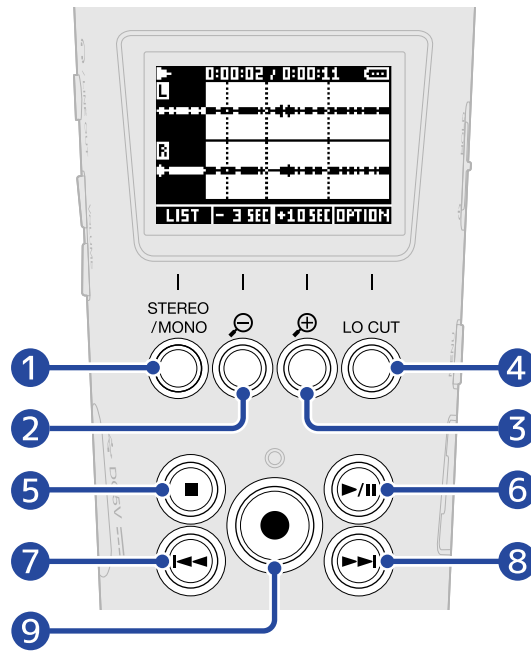
2. Press .
This stops playback and reopens the Home Screen.

Playback Screen operations



- 1 LIST**
This opens the [FILE LIST Screen](#).
- 2 - 3 SEC**
This moves the playback position 3 seconds backward.
- 3 +10 SEC**
This moves the playback position 10 seconds forward.
- 4 OPTION**
This opens the file options, which include operations explained in the following sections: [Optimizing file volume \(normalization\)](#), [Changing bit depth and exporting files \(Export\)](#), [Checking file information](#), and [Deleting files](#).
- 5** 
This stops playback and reopens the Home Screen.
- 6** 
This pauses and resumes playback.
- 7** 
This moves to the beginning of the file or the previous mark or plays the previous file.
Press and hold this to search backward in the file.
- 8** 
This moves to the next mark or plays the next file.
Press and hold this to search forward in the file.



9





This adds a mark at the current playback position. If there is already a mark at the current playback position, that mark will be deleted. (→ [Adding/deleting marks during playback](#))

Adding/deleting marks during playback



Marks can be added to a file while it is being played.

Added marks are shown on the Playback Screen where  and  can be used to move the playback position between them.

Adding marks

1. When the [Playback Screen](#) is open, press  to add a mark at the desired playback position.
A mark will be added at the playback position when  is pressed.



Deleting marks

1. When paused on the [Playback Screen](#), use  and  to move to the playback position with the mark to be deleted.
2. Press .
The mark at that playback position will be deleted.

Using automatic playback volume adjustment

By setting "Auto Play Vol" to "On", the playback volume can be made more even, regardless of the recording level loudness.

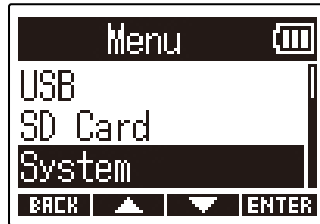

1. Press  when the Home Screen is open.
This opens the Menu Screen.

2. Use  and  to select "System" and press **ENTER** to confirm.

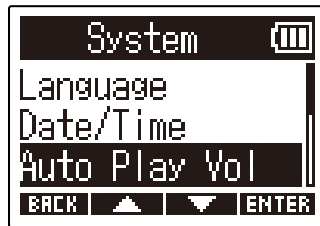

3. Use  and  to select "Auto Play Vol" and press **ENTER** to confirm.



4. Use  and  to select "On" and press  to confirm.

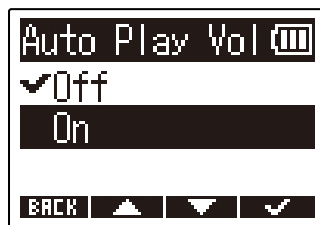

When "Auto Play Vol" is set to "On",  will appear at the top right of the Playback Screen.

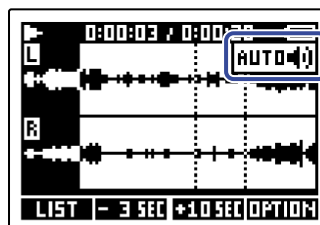

Managing files

Files created by the M2 are saved on the microSD card.

Recording files on the microSD card can be selected. Then, they can be normalized, have their bit depths converted or be deleted.

M2 folder and file structure

Folder and file structure

When recording with the M2, files are created on microSD cards in the following manner.

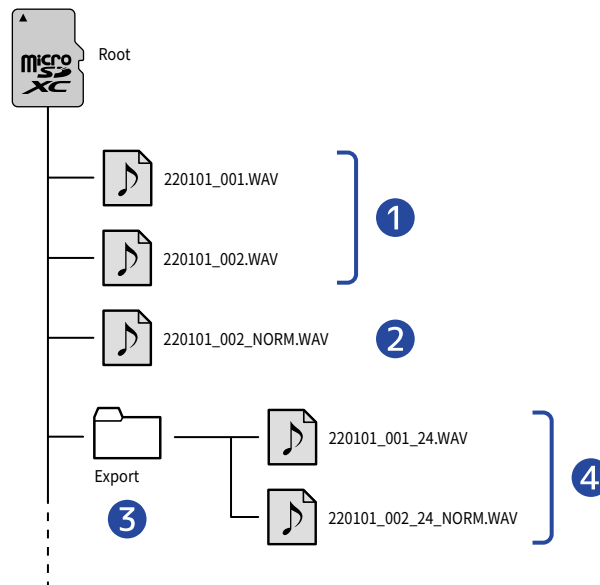

1 Recording files

Files recorded by the M2 are saved in the root folder on the microSD card.

- When the channel format of recorded audio is STEREO: a single stereo file with two audio tracks will be recorded.
- When the channel format of recorded audio is MONO: a single mono file with one audio track will be recorded.

See "[Changing the stereo/mono setting](#)" for details about the channel format of recorded audio.

2 Normalized file

This file has been processed with normalization. (→ [Optimizing file volume \(normalization\)](#))

This type of file is saved in the root folder of the microSD card in the same way as recorded files.

3 Export folder

This is created when files are exported. Files produced by exporting are saved in the Export folder.

(→ [Changing bit depth and exporting files \(Export\)](#))

4 Exported files

Files created by conducting file export are saved in the Export folder. (→ [Changing bit depth and exporting files \(Export\)](#))

Recording file naming

File names are assigned in the following format.

File name example	Explanation
<p>20220101_001.WAV</p> <p>1 2</p>	<ol style="list-style-type: none">1 Date The set date is used2 Take number This number is increased by one every time recording is started anew. In addition, if the file size exceeds 2 GB when recording for a long time, the new file that is created will also be numbered one higher.

NOTE:

- If the file size exceeds 2 GB, a new file will be created automatically and recording will continue without pause. When this happens, the take number for the newly created file will be increased by one.
- Normalized files will be saved in the root folder using the name of the original file with “_NORM.WAV” added to the end. (→ [Optimizing file volume \(normalization\)](#))
- Files created by exporting will be saved in the Export folder using the name of the original file with “_xx_yy.WAV” added to the end. ([Changing bit depth and exporting files \(Export\)](#))
 - xx: bit depth (16/24)
 - yy: normalize setting (“NORM” when on or nothing when off)
- The M2 cannot play files in the Export folder.

Checking files (FILE LIST Screen)

Use the [FILE LIST Screen](#) to check files on the microSD card. Files can also be played and deleted on this screen.

1. Press **LIST** on the [Playback Screen](#).



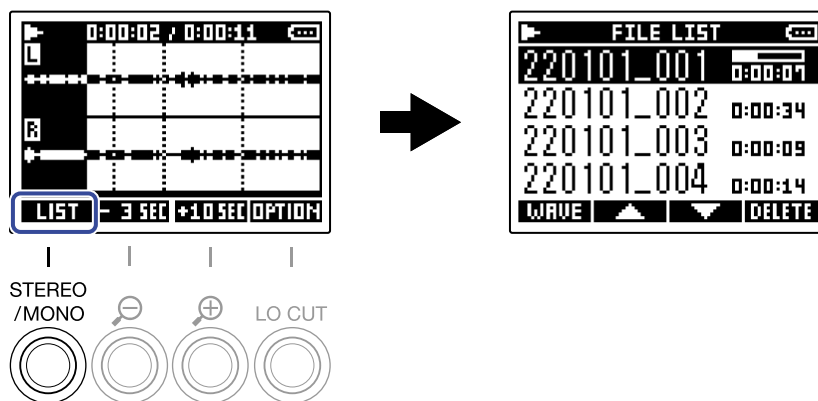



This will open the FILE LIST Screen, which shows a list of files on the microSD card.

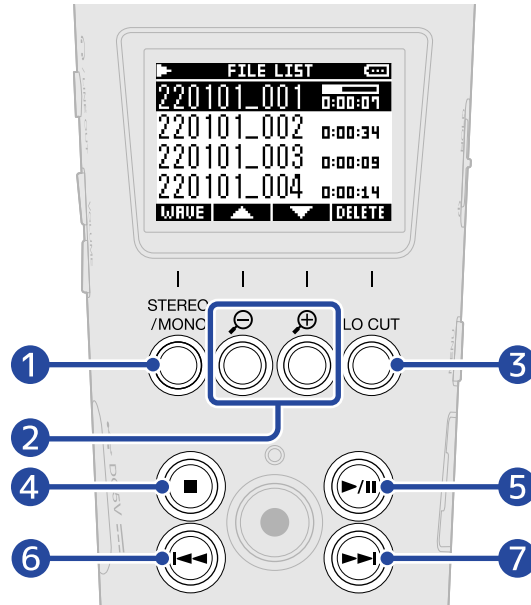

See "[FILE LIST Screen operations](#)" for details about operations when the FILE LIST Screen is open.

FILE LIST Screen operations



- 1** **WAVE**
This opens the [Playback Screen](#).
- 2**  / 
Use these to select the previous/next file.
- 3** **DELETE**
This deletes the selected file. (→ [Deleting files on the FILE LIST Screen](#))
- 4** 
This stops playback and reopens the Home Screen.
- 5** 
This pauses and resumes playback.
- 6** 
This moves to the beginning of the file or the previous mark or plays the previous file.
Press and hold this to search backward in the file.
- 7** 
This moves to the next mark or plays the next file.
Press and hold this to search forward in the file.

Deleting files

The selected file on the [FILE LIST Screen](#) and the playing file on the [Playback Screen](#) can be deleted.

Deleting files on the FILE LIST Screen

1. On the [FILE LIST Screen](#), use  and  to select the file to delete and press **DELETE**.

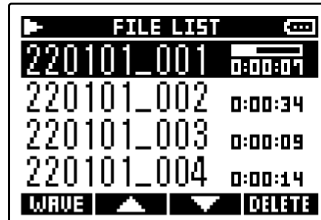

2. Use  and  to select "Delete" and press  to confirm.



Select "Cancel" to cancel deletion.

HINT:

Files can also be deleted on the Playback Screen. (→ [Deleting the playing file on the Playback Screen](#))

Deleting the playing file on the Playback Screen

1. Press **OPTION** on the [Playback Screen](#).
This shows the file options.



2. Use **▲** and **▼** to select "Delete" and press **ENTER**.

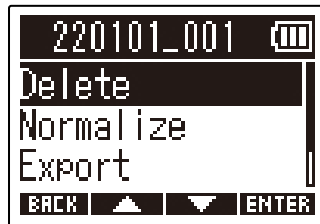

3. Use **▲** and **▼** to select "Delete" and press **✓** to confirm.



Select "Cancel" to cancel deletion.

HINT:

Files can also be deleted on the FILE LIST Screen by pressing **DELETE**. (→ [Deleting files on the FILE LIST Screen](#))

Optimizing file volume (normalization)

Volume can be optimized by normalizing recorded files.

1. Press **OPTION** on the [Playback Screen](#).
This shows the file options.



2. Use **▲** and **▼** to select "Normalize" and press **ENTER** to confirm.



3. Use **▲** and **▼** to select "Execute" and press **✓** to confirm.

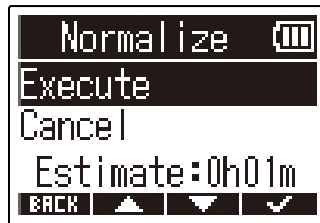

Select "Cancel" to return to the original screen.

NOTE:

Normalized files are saved with the same 32-bit format and can be played as is on the M2.

HINT:

Normalization is a function that measures the highest volume of the audio data and adjusts the volume, keeping it in a range that does not distort.

Changing bit depth and exporting files (Export)

The M2 can only record in 32-bit float format, but it can convert recorded files to other formats and export them. This is convenient when loading files recorded by the M2 on computers, smartphones and tablets when the application being used does not support 32-bit float format, for example.

When changing the file format, normalization can also be set to be used or not. The volume of recorded files can be optimized by normalizing.

1. Press **OPTION** on the [Playback Screen](#).

This shows the file options.





2. Use **▲** and **▼** to select "Export" and press **ENTER** to confirm.



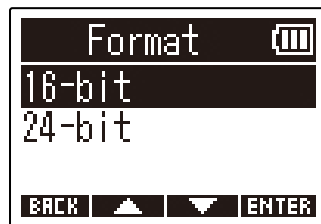

3. Use **▲** and **▼** to select the bit depth to use for the exported file, and press **ENTER** to confirm.

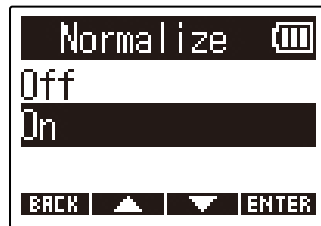

4. Use  and  to select whether or not to normalize and press **ENTER** to confirm.



Select "On" to normalize.

5. Use  and  to select "Execute" and press  to confirm.



The converted file will be saved in the Export folder.

Select "Cancel" to return to the original screen.

HINT:

Normalization is a function that measures the highest volume of the audio data and adjusts the volume, keeping it in a range that does not distort.

Checking file information

A variety of information about the current playback file can be checked.

1. Press **OPTION** on the [Playback Screen](#).
This shows the file options.



2. Use **▲** and **▼** to select "Information" and press **ENTER** to confirm.

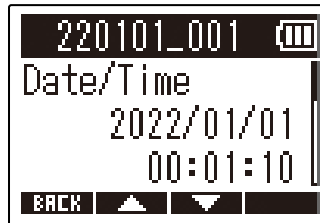

3. Use **▲** and **▼** to check the various information items.

File creation
date and time

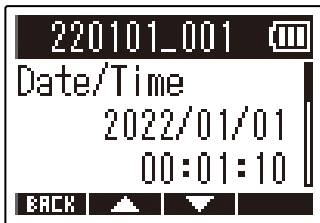

File format

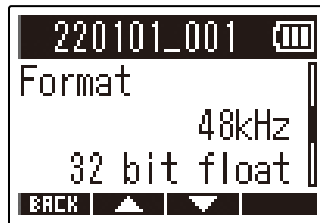

File length



Using as a USB mic

Signals input to the M2 can be sent to computers, smartphones and tablets, and playback signals from these devices can be output from the M2.

Moreover, the M2 can also record audio while being used as a USB mic.

Installing drivers

Windows computers

1. Download the M2 Driver to the computer from zoomcorp.com.

NOTE:

The latest M2 Driver can be downloaded from the above website.

2. Launch the installer, and follow the instructions to install the M2 Driver.

NOTE:



See the Installation Guide included in the driver package for detailed installation procedures.

Mac computers, smartphones and tablets

No driver is necessary for use with a Mac, smartphone or tablet.

Connecting computers, smartphones and tablets

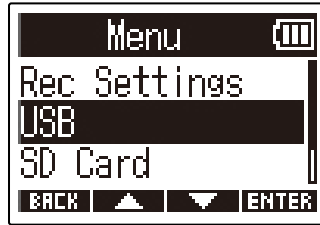

1. Press  when the Home Screen is open.
This opens the Menu Screen.

2. Use  and  to select "USB" and press **ENTER** to confirm.

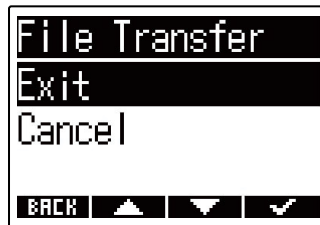

3. Use  and  to select "USB MIC w/REC" and press **ENTER** to confirm.



4. Use  and  to select the connected device and press **ENTER** to confirm.
When connected using the USB mic function, "USB MIC" will appear at the top left of the Home Screen.

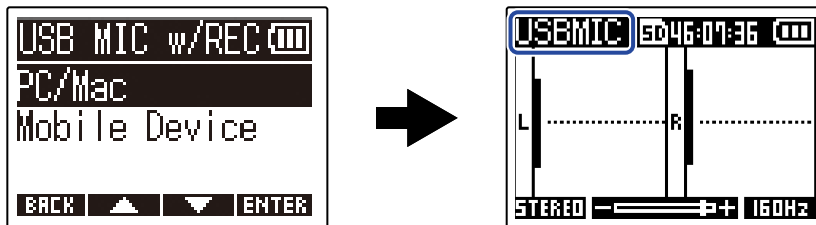

Setting	Explanation
PC/Mac	Use for connecting to a computer.
Mobile Device	Use for connecting to a smartphone or tablet. Please use batteries to power the M2.

NOTE:

- Bus power operation might not be possible depending on the USB bus power supply capability of the computer. In this case, select "Mobile Device" to power the unit with batteries when connecting.
- When used as a USB mic, the sample rate is 48 kHz.

5. Use a USB cable (Type-C) to connect the M2 to the computer, smartphone or tablet.

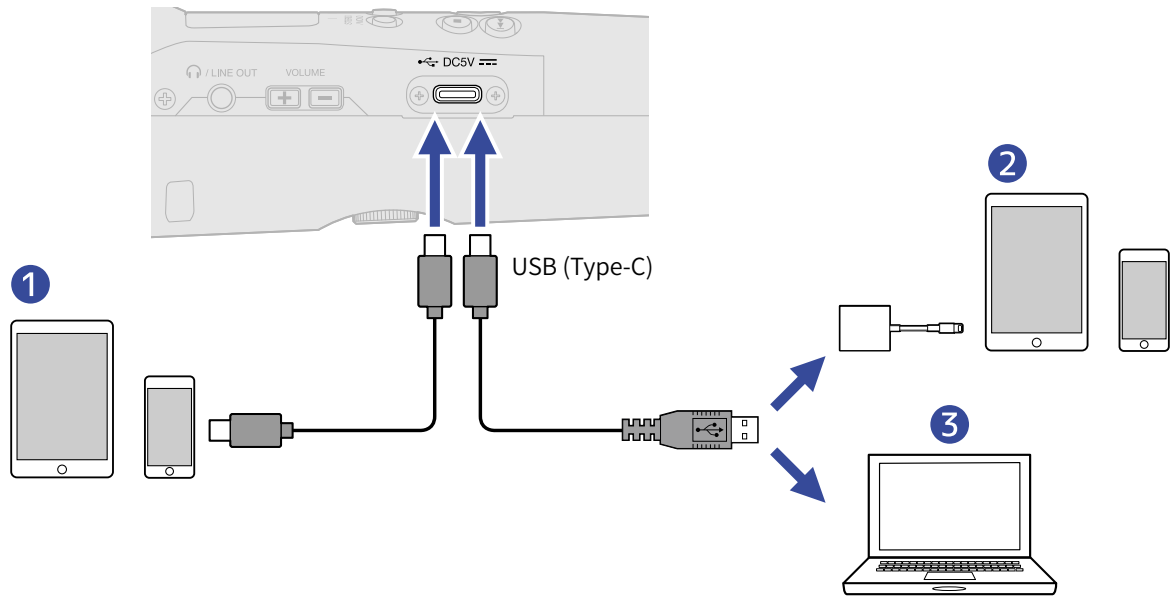

- ① Smartphone/tablet (Android)
- ② Smartphone/tablet (iOS/iPadOS)
- ③ Computer (Windows/Mac)

NOTE:

- Use a USB cable that supports data transfer.
- Use a Lightning to USB 3 Camera Adapter to connect to an iOS/iPadOS device with a lightning connector.

6. Launch an application on the computer, smartphone or tablet and select the M2 as the “Audio” or “Input/Output” device.

NOTE:

- Even if “ZOOM M2” cannot be selected in the computer “Sound” settings, the M2 can still be used as a 32-bit float USB mic if it is selected as the “Audio” or “Input/Output” device in an application that supports 32-bit float format.
- See the operation manuals of the applications for information about their operation.

USB mic muting

When connected using the USB mic function, temporarily muting the sound from the mic is possible so that it is not sent to the computer, smartphone or tablet.

1. Press  when the Home Screen is open (and connected using the USB mic function).

The MUTE message will be shown and output to the computer, smartphone or tablet will be muted.

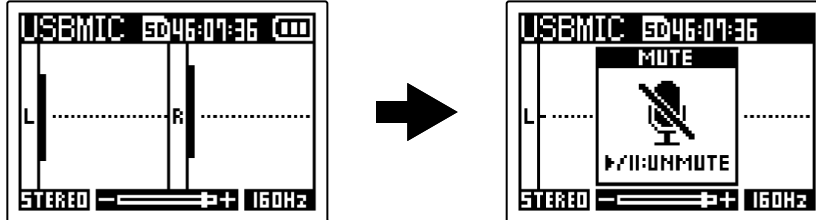

2. Press  when muted.

This unmutes the output and returns to the previous screen.

NOTE:

Sound being recorded and sound output from the PHONE/LINE OUT jack are also muted in the same manner.

Disconnecting from computers, smartphones and tablets

1. Press  when the Home Screen is open (and connected using the USB mic function).
This opens the Menu Screen.

2. Use  and  to select "Exit USB MIC" and press **ENTER** to confirm.

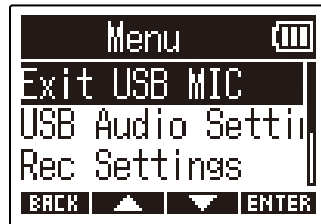

3. Disconnect the USB cable that is connecting the M2 and the computer, smartphone or tablet.

Making USB mic settings

When the M2 is used as a USB mic, the monitoring sound and the signal sent to the computer, smartphone or tablet can be set.

Changing the stereo/mono setting

The sound captured by the M2 can be mixed to mono for monitoring and sending to the computer, smartphone or tablet. This function is convenient for web streaming and other times when you do not want stereo audio sent to the computer, smartphone or tablet.

1. Press  when the Home Screen is open (and connected using the USB mic function).

Pressing this switches between STEREO and MONO.

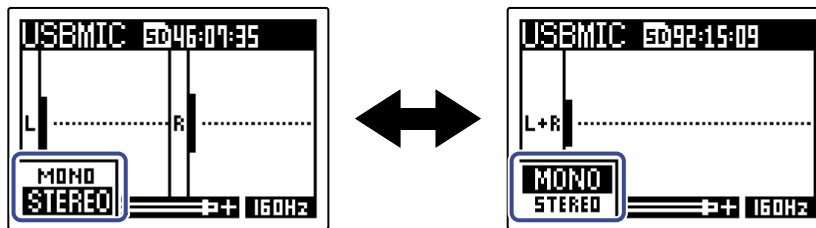

NOTE:

Recorded sound and sound output from the PHONE/LINE OUT jack are also switched in the same manner.

Reducing noise (low-frequency cut)

When using the M2 as a USB mic, low frequencies from the built-in XY mic can be cut, reducing the sound of wind and pop noises, for example.

1. On the Home Screen (when connected using the USB mic function), press  repeatedly to set the cutoff frequency.

The selected frequency is shown on the Home Screen.

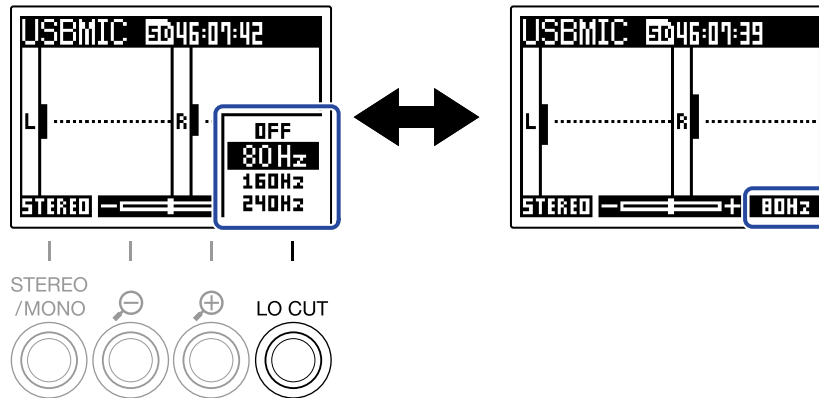

LO CUT can be set to OFF, 80Hz, 160Hz or 240Hz.

Setting the bit depth

The bit depth can be set for use as a USB mic.



Precautions when using 32-bit float format:

- Always confirm that the app being used on a computer, smartphone or tablet supports 32-bit float format before use.
- Before connecting the M2 to speakers or headphones, set the M2 headphone volume to 0. If using an app that does not support 32-bit float format, unexpected loud sound could be output causing harm to hearing, for example.
- A driver is necessary to use 32-bit float format with Windows. Download the driver from the ZOOM website (zoomcorp.com).

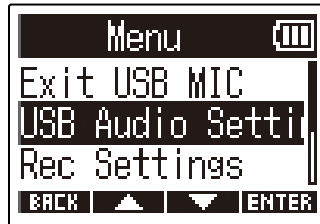

1. Press  when the Home Screen is open (and connected using the USB mic function).
This opens the Menu Screen.

2. Use  and  to select "USB Audio Setting" and press  to confirm.

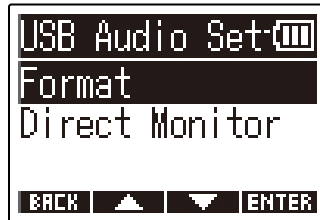

3. Use  and  to select "Format" and press  to confirm.



4. Use  and  to select the bit depth to use, and press  to confirm.

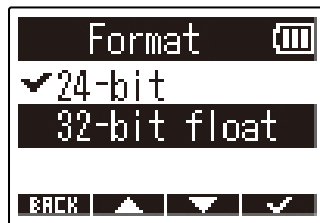

Enabling direct monitoring

This directly outputs the sound being input to the M2 before sending it to the computer, smartphone or tablet. This enables monitoring without latency (direct monitoring function).

1. Press  when the Home Screen is open (and connected using the USB mic function).
This opens the Menu Screen.

2. Use  and  to select "USB Audio Setting" and press  to confirm.

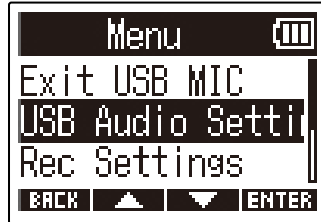

3. Use  and  to select "Direct Monitor" and press  to confirm.

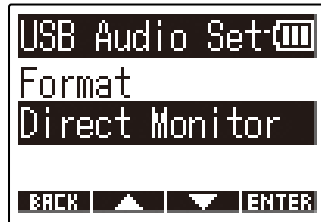

4. Use  and  to select "On" and press  to confirm.

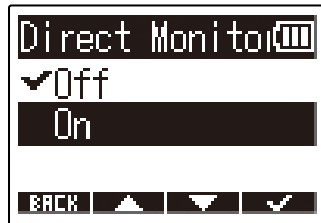



Transferring files to computers and other devices

By connecting the M2 to a computer, smartphone or tablet, files on the microSD card can be checked and moved.

Connecting computers, smartphones and tablets

1. Press  when the Home Screen is open.
This opens the Menu Screen.

2. Use  and  to select "USB" and press **ENTER** to confirm.



3. Use  and  to select "File Transfer" and press **ENTER** to confirm.



4. Use  and  to select the connected device and press **ENTER** to confirm.

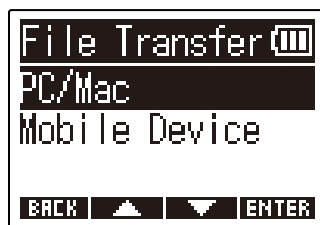

Setting	Explanation
PC/Mac	Use for connecting to a computer.
Mobile Device	Use for connecting to a smartphone or tablet. Please use batteries to power the M2.

This opens the File Transfer Screen.

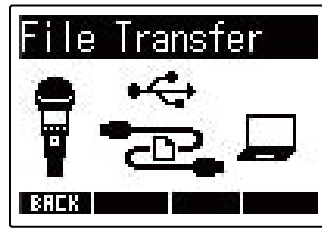

5. Use a USB cable (Type-C) to connect the M2 to the computer, smartphone or tablet.

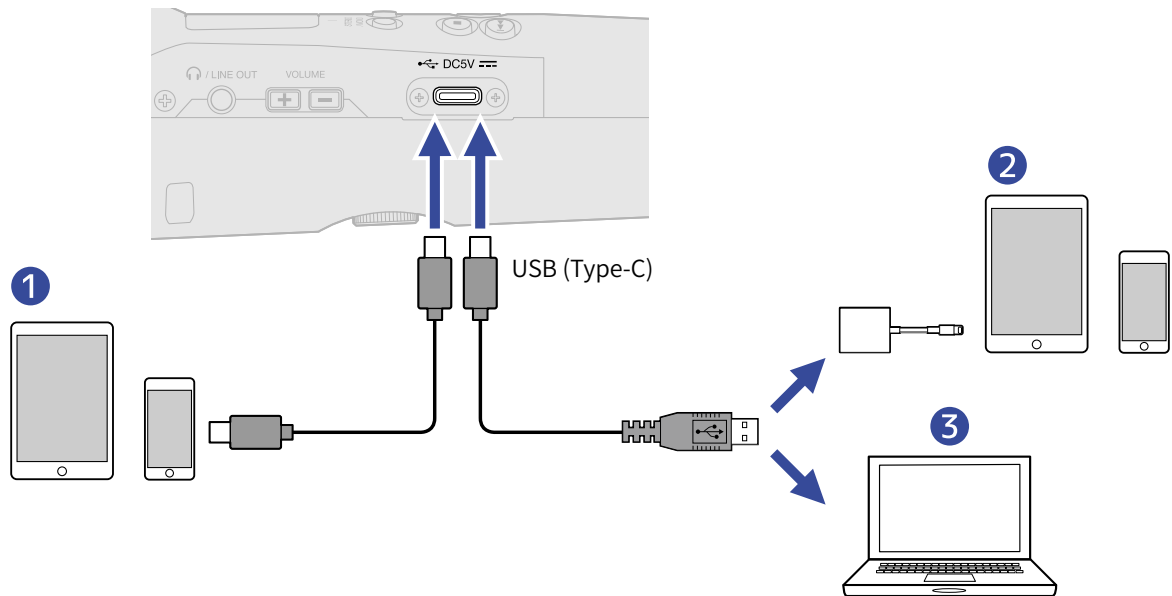

- 1 Smartphone/tablet (Android)
- 2 Smartphone/tablet (iOS/iPadOS)
- 3 Computer (Windows/Mac)

NOTE:

- Use a USB cable that supports data transfer.
- Use a Lightning to USB 3 Camera Adapter to connect to an iOS/iPadOS device with a lightning connector.

6. Use the computer, smartphone or tablet to work with files saved on the microSD card.

Disconnecting from computers, smartphones and tablets

1. End the connection from the computer, smartphone or tablet.

- Windows:
Select the M2 from "Safely Remove Hardware and Eject Media".
- macOS:
Drag the M2 icon to the Trash and drop it.
- Smartphone/tablet:
Refer to the operation manual for the device.

2. Press  or **BACK** .

This opens a confirmation screen.

3. Use  and  to select "Exit" and press  to confirm.

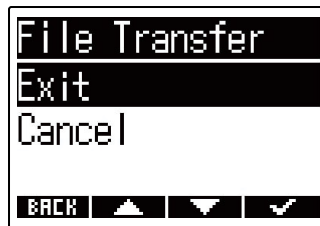

4. Disconnect the USB cable that is connecting the M2 and the computer, smartphone or tablet.

NOTE:



Always conduct procedure step 1 before disconnecting the USB cable.

Making various settings



Setting the language shown

The language shown on the M2 screen can be changed.

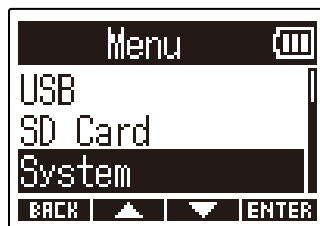

1. Press  when the Home Screen is open.
This opens the Menu Screen.

2. Use  and  to select "System" and press  to confirm.

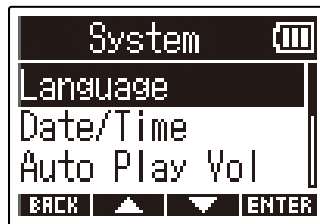

3. Use  and  to select "Language" and press  to confirm.



4. Use  and  to select the language to show, and press  to confirm.

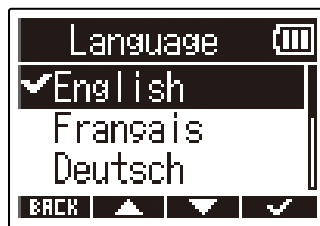

HINT:



The first time you turn the power on after purchase, this screen opens automatically.

Setting the date and time



Use this to set the date and time added to recording files.

1. Press  when the Home Screen is open.

This opens the Menu Screen.

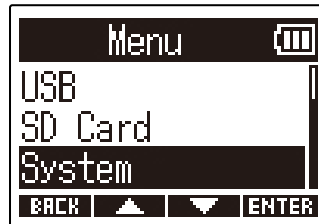
2. Use  and  to select "System" and press **ENTER** to confirm.





3. Use  and  to select "Date/Time" and press **ENTER** to confirm.



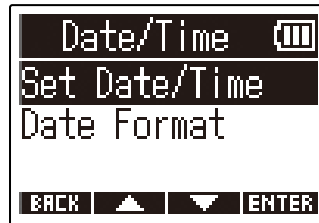

4. Use  and  to select "Set Date/Time" and press **ENTER** to confirm.

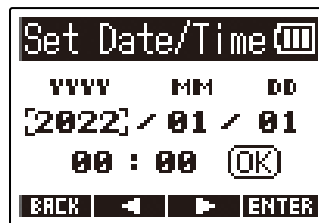

5. Use  and  to select the item to set, and press **ENTER** to confirm.



6. Use  and  to change the value, and press  to confirm.

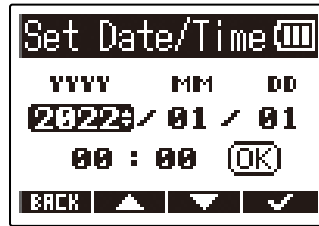

7. Repeat steps 5–6 to set the date and time.

8. After setting all items, use  and  to select , and press  to confirm.

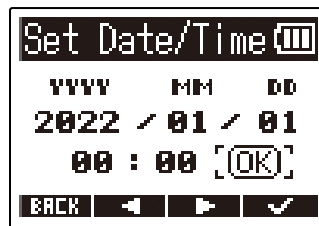

NOTE:

Changing the date and time will also reset the take numbers used for recording files.

HINT:



The first time you turn the power on after purchase, this screen opens automatically after you set the date format.

Setting the date format



The date format used with recording files can be changed.

1. Press  when the Home Screen is open.

This opens the Menu Screen.

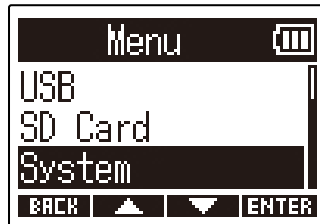
2. Use  and  to select "System" and press **ENTER** to confirm.





3. Use  and  to select "Date/Time" and press **ENTER** to confirm.

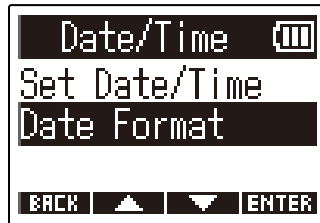

4. Use  and  to select "Date Format", and press **ENTER** to confirm.



5. Use  and  to select the date format, and press  to confirm.

The current set date will be shown at the bottom of the screen as a concrete example of the date format set.

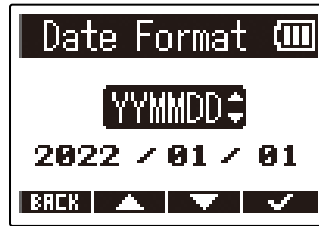

Setting	Explanation
YYMMDD	The date is shown in year, month, day order.
MMDDYY	The date is shown in month, day, year order.
DDMMYY	The date is shown in day, month, year order.

NOTE:

Changing the date format will also reset the take numbers used for recording files.

HINT:



The first time you turn the power on after purchase, this screen opens automatically after you set the language shown.

Setting the display backlight



The display backlight can be set to stay on or off.

1. Press  when the Home Screen is open.

This opens the Menu Screen.

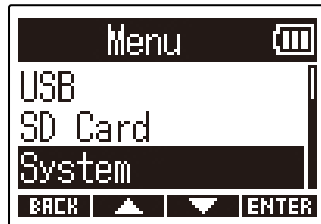
2. Use  and  to select "System" and press **ENTER** to confirm.





3. Use  and  to select "Display" and press **ENTER** to confirm.

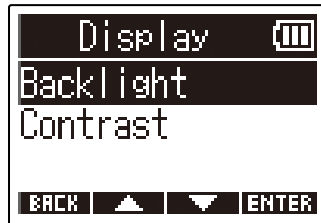

4. Use  and  to select "Backlight" and press **ENTER** to confirm.



5. Use  and  to select a setting, and press  to confirm.

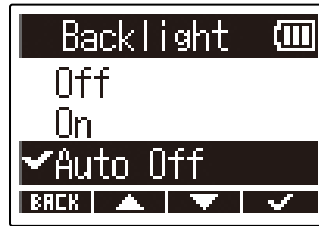



Setting	Explanation
Off	The display backlight always stays off.
On	The display backlight always stays on.
Auto Off	The display backlight turns off if no operation occurs for a certain amount of time.

Setting the display contrast



The contrast can be adjusted if the display appears too light or too dark, making it difficult to view.

1. Press  when the Home Screen is open.

This opens the Menu Screen.

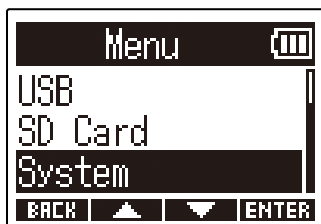
2. Use  and  to select "System" and press  to confirm.



3. Use  and  to select "Display" and press  to confirm.



4. Use  and  to select "Contrast" and press  to confirm.

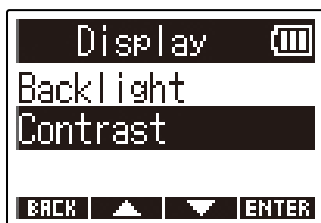

5. Use  and  to adjust the display contrast, and press  to confirm.

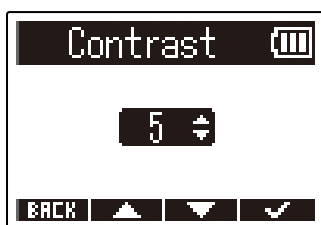





HINT:

This can be set from 1 to 10.



Setting the type of batteries used

Set the type of battery used by the M2 correctly so that the amount of remaining battery charge can be accurately displayed.

1. Press  when the Home Screen is open.
This opens the Menu Screen.

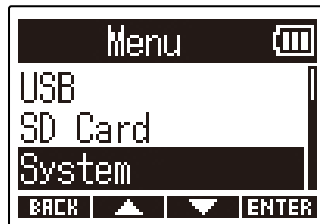
2. Use  and  to select "System" and press  to confirm.



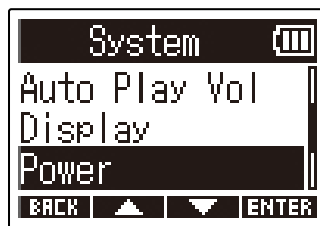

3. Use  and  to select "Power" and press  to confirm.

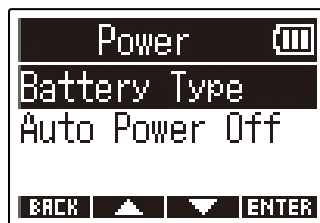

4. Use  and  to select "Battery Type" and press  to confirm.



5. Use  and  to select the battery type, and press  to confirm.

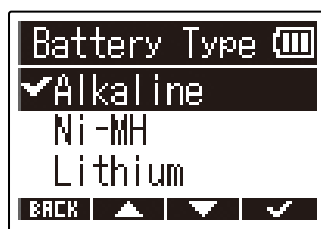

Setting	Explanation
Alkaline	Alkaline batteries
Ni-MH	Nickel-metal hydride batteries
Lithium	Lithium batteries



HINT:

The first time you turn the power on after purchase, the battery type setting is shown after you set the date and time.



Setting the time until the power turns off automatically (Auto Power Off)

The M2 can be set to automatically turn off if it is not operated for a specific amount of time. To keep the power on at all times, set Auto Power Off to Off.

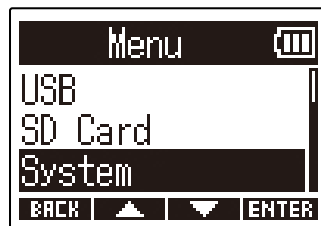

1. Press  when the Home Screen is open.
This opens the Menu Screen.

2. Use  and  to select "System" and press  to confirm.



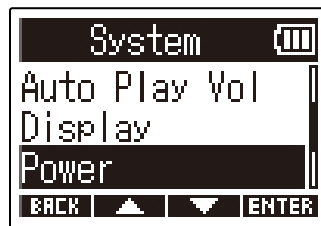

3. Use  and  to select "Power" and press  to confirm.

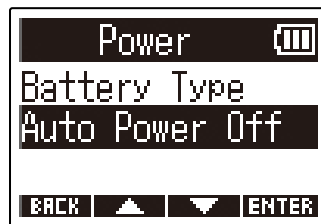

4. Use  and  to select "Auto Power Off" and press  to confirm.



5. Use  and  to select the amount of time until the power turns off, and press  to confirm.

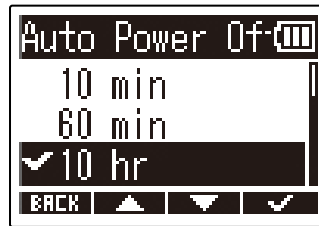

Setting	Explanation
Off	The power will not turn off automatically
10 min	The power will automatically turn off if it is unused for 10 minutes.
60 min	The power will automatically turn off if it is unused for 60 minutes.
10 hr	The power will automatically turn off if it is unused for 10 hours.

NOTE:

Regardless of the Auto Power Off setting, the power will not turn off automatically under the following conditions.



- When recording or playing back
- When the M2 is being used as a USB mic
- When the M2 is being used as a card reader.
- When a card test is being executed
- When firmware is being updated

Managing microSD cards



Formatting microSD cards

To maximize the performance of a microSD card, format it for use with the M2.

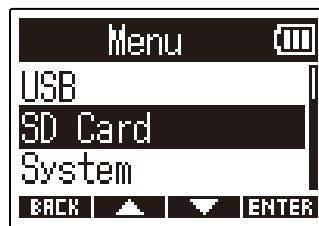

1. Press  when the Home Screen is open.
This opens the Menu Screen.

2. Use  and  to select "SD Card" and press  to confirm.

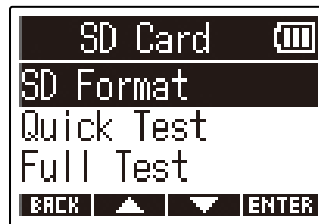

3. Use  and  to select "SD Format" and press  to confirm.



4. Use  and  to select "Execute" and press  to confirm.

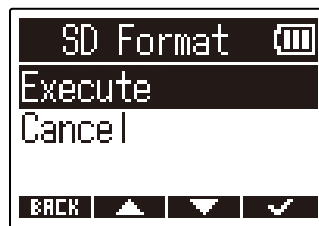

This formats the microSD card.

NOTE:

- The microSD card formatting screen can also be opened by pressing  while turning the power on.
- Always format microSD cards in order to maximize their performance after purchasing them new or using them with a different device.
- Be aware that all data on the microSD card will be deleted when it is formatted.

Testing microSD cards



This tests whether the microSD card writing speed performance can save data recorded by the M2 without problems.

A Quick Test can be done in a short amount of time, while a Full Test examines the entire microSD card.



Conducting a quick test

1. Press  when the Home Screen is open.

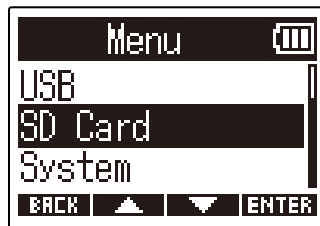

This opens the Menu Screen.

2. Use  and  to select "SD Card" and press  to confirm.

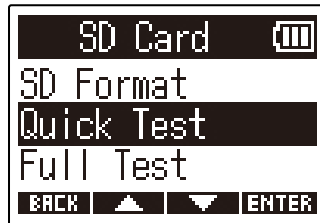

3. Use  and  to select "Quick Test" and press  to confirm.



4. Use  and  to select "Execute" and press  to confirm.

The card performance test will start.

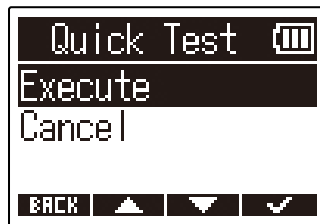

The result of the test will be shown when it completes.

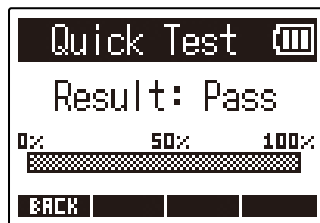

NOTE:



Even if a performance test result is "OK", there is no guarantee that writing errors will not occur. This information is just to provide guidance.

HINT:



Testing can be canceled while in progress by pressing **BACK** .

Conducting a full test

1. Press  when the Home Screen is open.
This opens the Menu Screen.

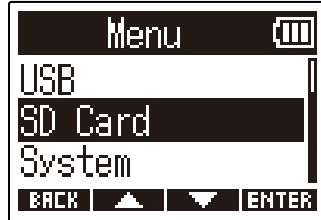

2. Use  and  to select "SD Card" and press  to confirm.

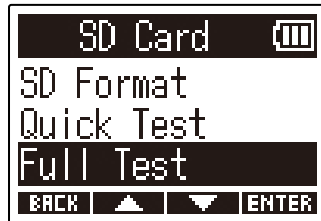

3. Use  and  to select "Full Test" and press  to confirm.



The amount of time required for the full test will be shown.

4. Use  and  to select "Execute" and press  to confirm.
The card performance test will start.

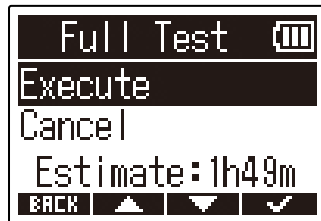

The result of the test will be shown when it completes.

If the access rate MAX reaches 100%, the card will fail (NG).

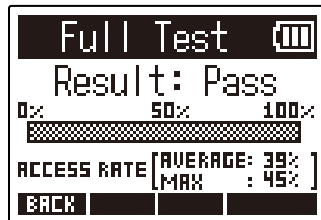

NOTE:

Even if a performance test result is "OK", there is no guarantee that writing errors will not occur. This information is just to provide guidance.

HINT:



Testing can be paused by pressing **PAUSE** , and resumed by pressing **RESTART** .

Testing can be canceled while in progress by pressing **BACK** .

Restoring factory default settings

You can restore the M2 settings to their factory defaults.

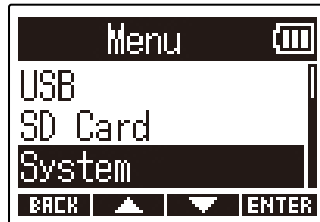

1. Press  when the Home Screen is open.
This opens the Menu Screen.

2. Use  and  to select "System" and press **ENTER** to confirm.

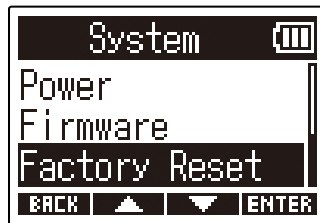

3. Use  and  to select "Factory Reset" and press **ENTER** to confirm.



4. Use  and  to select "Execute" and press  to confirm.



This will restore the M2 to its factory default state and turn the power off.

NOTE:



Resetting will overwrite all settings to their factory defaults. Be certain before using this function.

Managing the firmware



Checking the firmware versions

The firmware versions used by the M2 can be checked.

1. Press  when the Home Screen is open.
This opens the Menu Screen.

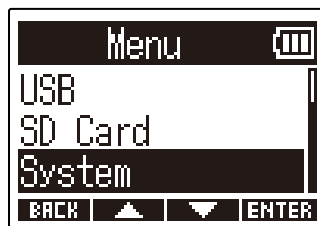
2. Use  and  to select "System" and press  to confirm.



3. Use  and  to select "Firmware" and press  to confirm.

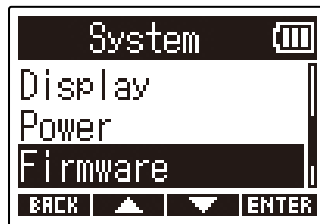

This shows the firmware versions.

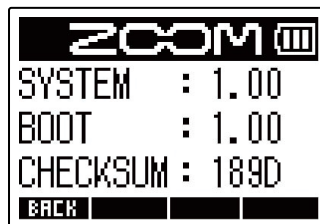

Updating the firmware

The M2 firmware can be updated to the latest versions.

Files for the latest firmware updates can be downloaded from the ZOOM website (zoomcorp.com). Follow the instructions in the "M2 Firmware Update Guide" on the M2 download page.

Appendix

Troubleshooting

If you think that the M2 is operating strangely, check the following items first.

Recording/playback trouble

There is no sound or output is very quiet

- Confirm that the volume of the headphones, for example, is not set low. (→ [Monitoring input and playback sounds](#))

The built-in mic sound cannot be heard or is very quiet

- Increase the volume amplification on the display for the input signal, and increase the monitoring volume. (→ [Adjusting the volume display size to make checking easier](#))

Recording is not possible

- Recording can only be started on the Home Screen. (→ [Recording](#))
- Confirm that the microSD card has open space. The available recording time can be checked on the screen when recording is paused. (→ [Home Screen](#))
- Confirm that a microSD card is loaded properly in the card slot. (→ [Inserting microSD cards](#))

“MIC INPUT OVERLOAD!” appears

- The volume input to the mic is too loud. Increase the distance between the M2 and the sound source.
- Wind can cause loud noise to be input. We recommend using a windscreen (included) if air is blown directly at the mic, for example, when recording outdoors or when the mic is near the mouth of a speaker. (→ [Reducing noise \(low-frequency cut\)](#))

Other trouble

The recorder is not recognized by a computer, smartphone or tablet even though the USB port is connected to it.

- Use a USB cable that supports data transfer.
- The operation mode must be set on the M2 to allow the computer, smartphone or tablet to recognize it. (→ [Connecting computers, smartphones and tablets](#), [Transferring files to computers and other devices](#))
- When using as a 32-bit float USB mic, confirm that the computer, smartphone or tablet and applications being used support 32-bit float format.
- Even if “ZOOM M2” cannot be selected in the computer “Sound” settings, the M2 can still be used as a 32-bit float USB mic if it is selected as the “Audio” or “Input/Output” device in an application that supports 32-bit float format.
- A driver is necessary to use 32-bit float format with Windows. Download the driver from the ZOOM website (zoomcorp.com).

Battery operation time is short

Making the following settings could increase the battery operation time.

- Set the type of batteries used correctly. (→ [Setting the type of batteries used](#))
- Turn the display backlight off or set it to turn off after a set amount of time without use. (→ [Setting the display backlight](#))
- Reduce the sampling rate used to record files. (→ [Setting the sample rate](#))
- Disconnect unnecessary cables from the PHONE/LINE OUT jack.
- Due to their characteristics, using nickel metal hydride batteries (especially high-capacity ones) or lithium batteries should enable longer use than alkaline batteries when power consumption is high.

Specifications

Input	Built-in mic	90° XY stereo format	
		Directionality	Unidirectional
		Sensitivity	-42 dB/1 Pa at 1 kHz
		Maximum sound pressure input	135 dB SPL
Outputs	PHONE/LINE OUT jack	Connector	Stereo mini jack
		Maximum output level	20 mW + 20 mW (into 32Ω load)
		Output impedance	10 Ω or less
	Built-in speaker		500mW 8Ω mono speaker
Recorder		Recording format	WAV 44.1/48/96 kHz, 32-bit float Stereo/mono BWF and iXML formats supported
		Recording media	4-32GB cards compatible with the microSDHC specification 64GB-1TB cards compatible with the microSDXC specification
Display			96×64 LCD with backlight
USB	Connector		USB Type-C • Use a USB cable that supports data transfer.
	USB Mic		USB 2.0 High Speed 48 kHz 24-bit or 32-bit float
	File transfer		USB 2.0 High Speed
Power			2 AA batteries (alkaline, NiMH or lithium) AC adapter (ZOOM AD-17): DC 5 V/1 A • USB bus power is supported.
Estimated continuous operation times using batteries		Stereo recording, 48kHz/32-bit float, no headphones, display backlight off	Alkaline batteries: about 11 hours NiMH batteries (1900 mAh): about 10.5 hours Lithium batteries: about 22 hours
<ul style="list-style-type: none"> • These values are approximate. • Continuous battery operation times were determined using in-house testing methods. They will vary greatly according to use conditions. 			
Power consumption			5 W maximum

Dimensions	221.5 mm (W) × 61.9 mm (D) × 59.3 mm (H)
Weight (including batteries)	204 g

Note: 0 dBu = 0.775 Vrms



ZOOM CORPORATION

4-4-3 Kanda-surugadai, Chiyoda-ku, Tokyo 101-0062 Japan

zoomcorp.com