

G6

Multi-Effects Processor

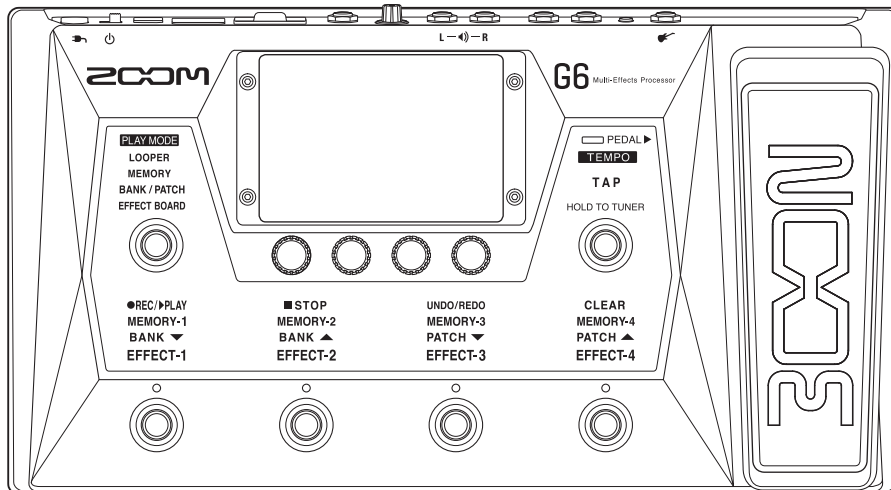

Operation Manual

You must read the Usage and Safety Precautions before use.

© 2020 ZOOM CORPORATION

Copying or reprinting this manual in part or in whole without permission is prohibited.

Product names, registered trademarks and company names in this document are the property of their respective companies. All trademarks and registered trademarks in this document are for identification purposes only and are not intended to infringe on the copyrights of their respective owners.

Proper display is not possible on grayscale devices.

Notes about this Operation Manual

You might need this manual in the future. Always keep it in a place where you can access it easily.

The contents of this document and the specifications of the product could be changed without notice.

© Windows® is a trademark or registered trademark of Microsoft® Corporation.

© iPhone, iPad, iPadOS and Mac are trademarks of Apple Inc.

© App Store is a service mark of Apple Inc.

© iOS is a trademark or registered trademark of Cisco Systems, Inc. (USA).

© The SD, SDHC and SDXC logos are trademarks.

© Other product names, registered trademarks and company names in this document are the property of their respective companies.

- All trademarks and registered trademarks in this document are for identification purposes only and are not intended to infringe on the copyrights of their respective owners.
- Recording from copyrighted sources, including CDs, records, tapes, live performances, video works and broadcasts, without permission of the copyright holder for any purpose other than personal use is prohibited by law. Zoom Corporation will not assume any responsibility related to infringements of copyrights.

Terms used in this manual

Patch memory

Combinations of amps and effects with their on/off settings and parameter values can be saved as "patch memories" for easy recall. Effects are saved and recalled in patch memory units. Up to 9 effects can be added to a patch memory, and up to 240 patch memories can be stored.

Bank

One group of 4 patch memories is a "bank". Patch memories can be quickly recalled by switching banks. Up to 60 banks can be saved.

Effect type

The available effect types include various guitar effects and amp/cabinet simulation models. Effects can be selected from these types to be added to patch memories.

Category

Effects are grouped into categories by type.

AUTOSAVE

This function automatically saves changes to patch memory and effect settings.

ECO mode

This function will automatically turn the power off 10 hours after the last operation.

Looper

Stereo phrases that are up to 45 seconds long can be recorded and played back repeatedly.

By using an SD card, the recording time can be lengthened and phrases can be saved. You can also use your own audio files as loops.

Contents

Notes about this Operation Manual	2	Changing patch memory names	54
Terms used in this manual	3	Adjusting the master tempo	55
Contents	4	Managing patch memories	56
G6 overview	6	Saving patch memories	56
Using the touchscreen	8	Changing the order of patch memories	58
Functions of parts	11	Deleting patch memories	59
Connecting	16	Creating patch memories	60
Inserting SD cards	17	Managing banks	63
Turning the power on/off	18	Changing the bank order	63
Turning the power on	18	Deleting banks	64
Turning the power off	18	Creating banks	66
Adjusting the master level	19	Using expression pedals	68
Adjusting the master EQ	20	Using the built-in pedal	68
Turning effects on and off while playing	21	Adjusting the pedal	70
Switching banks and patch memories while playing	23	Using an external pedal.....	72
Switching patch memories in one bank while playing	25	Using the tuner	74
Using the looper while playing	27	Activating the tuner	74
Setting the looper	32	Changing tuner settings	75
Using SD cards	37	Using rhythms	77
Adjusting effects	40	Activating rhythms.....	77
Turning effects on and off	40	Setting rhythms.....	78
Replacing effects	41	Starting/stopping rhythm playback	82
Adjusting effects	44	Rhythm patterns	83
Changing effect order	46	Using the send and return	84
Adding effects	47	Using impulse responses (IR)	86
Deleting effects.....	49	Using impulse responses (IR).....	86
Making all settings on one screen	50	Loading impulse response (IR) data	87
Setting the patch memory level	53	Using audio interface functions	89
		Installing the driver	89
		Connecting to a computer	90
		Making audio interface settings	91
		Connecting to iOS/iPadOS devices	93

- Making unit settings**..... 94
 - Setting the AUTOSAVE function 94
 - Adjusting the brightness of the touchscreen 95
 - Setting the ECO mode 96
- Managing the firmware** 97
 - Checking the firmware versions 97
 - Updating 98
 - Restoring factory default settings 99
- Managing SD cards**..... 100
 - Checking SD card information 100
 - Formatting SD cards 101
 - Using as a card reader 103
- Troubleshooting** 105
- Specifications** 107

G6 overview

■ Signal flow

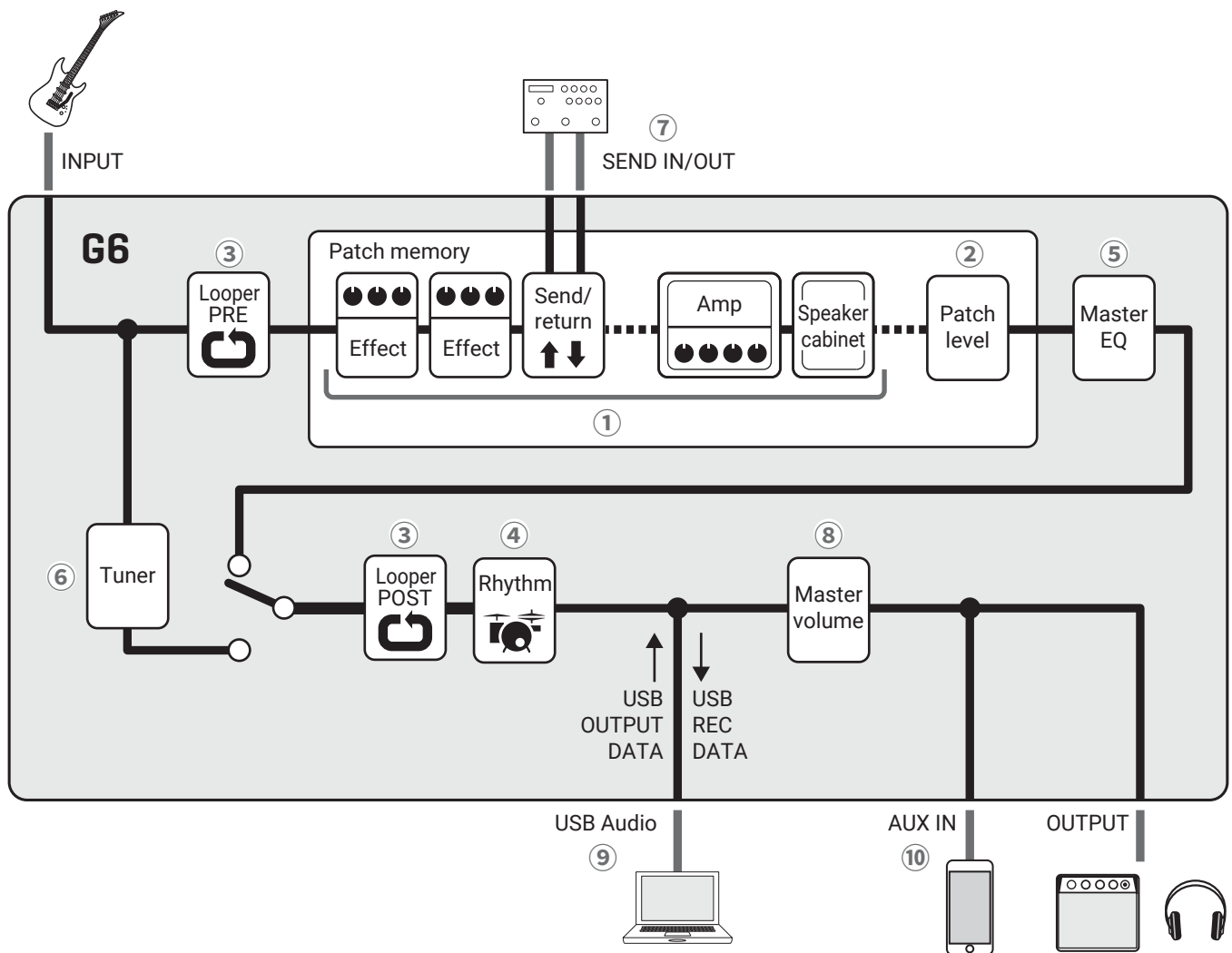

① The input guitar sound passes through the effects, amp and speaker cabinet in order.

(→ [“Adjusting effects” on page 40](#))

② The patch memory level is adjusted.

(→ [“Setting the patch memory level” on page 53](#))

③ Recorded phrases can be played back in loops. The looper can be placed in either the PRE or POST position.

(→ [“Using the looper while playing” on page 27](#))

④ Drum sounds can be played back using built-in rhythm patterns.

(→ [“Using rhythms” on page 77](#))

⑤ The overall sound is adjusted. This setting is retained even when the patch memory is changed.

(→ [“Adjusting the master EQ” on page 20](#))

⑥ The connected guitar can be tuned.

(→ [“Using the tuner” on page 74](#))

⑦ An external effect can be used.

(→ [“Using the send and return” on page 84](#))

⑧ The overall volume can be adjusted. This setting is retained even when the patch memory is changed.

(→ [“Adjusting the master level” on page 19](#))

⑨ Audio data can be exchanged with a computer using the audio interface function.

(→ [“Using audio interface functions” on page 89](#))

⑩ Audio can be played back from a smartphone, mobile audio player or other device.

■ Memory overview (patch memories/banks)

Patch memories

These store the effects used, their order, on/off states and parameter setting values. Effects can be saved and recalled in patch memory units. 240 patch memories can be stored.

Banks

These are groups of 4 patch memories. 60 banks can be stored.

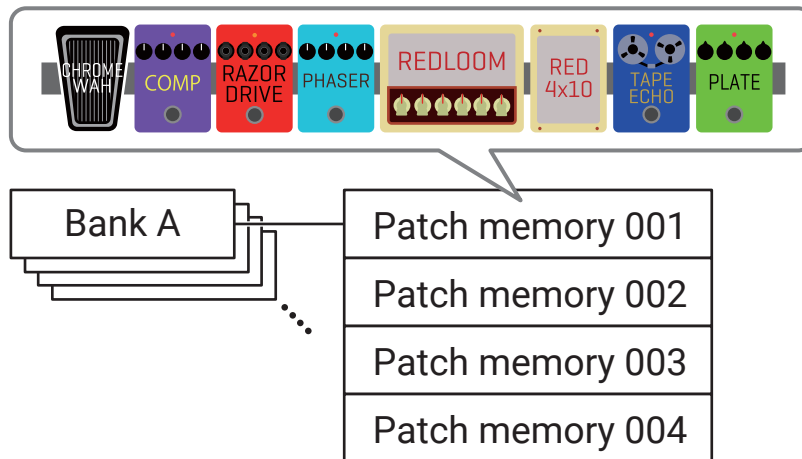

■ PLAY MODE overview

The **G6** has four play modes that can be selected with one touch using the PLAY MODE selection section (→ [page 11](#)). Use them for their different purposes while performing.

PLAY MODE	Explanation
LOOPER	The looper appears on the touchscreen and can be operated using the footswitches. (→ “Using the looper while playing” on page 27)
MEMORY	Banks and the patch memories in them are shown on the touchscreen, and patch memories can be selected using footswitches. (→ “Switching patch memories in one bank while playing” on page 25)
BANK / PATCH	Patch memory names are shown with large characters on the touchscreen, and banks and patch memories can be selected using footswitches. (→ “Switching banks and patch memories while playing” on page 23)
EFFECT BOARD	The effects used in a patch memory are shown on the touchscreen, and each effect can be turned on/off using footswitches. (→ “Turning effects on and off while playing” on page 21)

Using the touchscreen

Operating and setting the **G6** can be done using the touchscreen.

This section explains touchscreen operations.

Screens that appear on the touchscreen

■ PLAY MODE screens

These appear when the power is turned on, and when a play mode is selected in the PLAY MODE selection section (→ [page 11](#)).

LOOPER

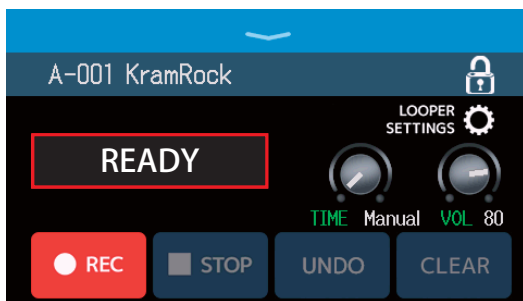

MEMORY



BANK / PATCH



EFFECT BOARD

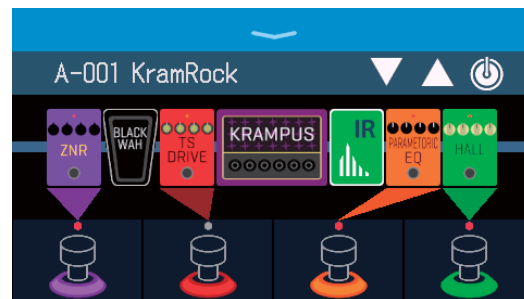

■ Menu Screen

All **G6** functions are arranged as icons on the Menu Screen, so each one can easily be accessed by touch.

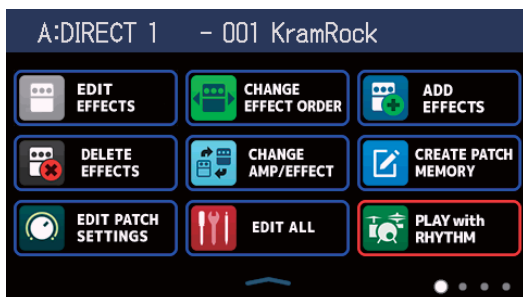

Opening the Menu Screen

When a PLAY MODE screen is open

Swipe down from the toolbar.

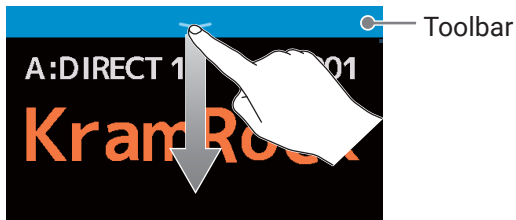

When a setting screen is open

Touch < BACK repeatedly.

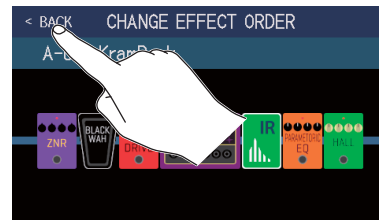

Using the Menu screen

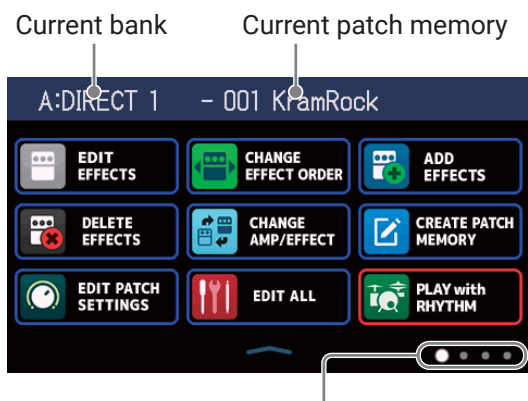

The Menu Screen has four pages. This shows which page is currently open.

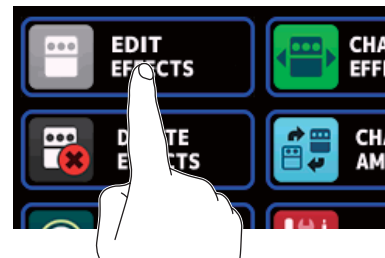

Touch an icon to select a function to set or adjust.

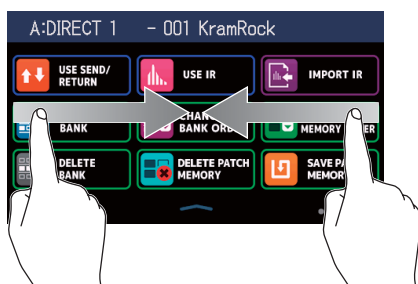

To open the page to the left, swipe right from the left edge.

To open the page to the right, swipe left from the right edge.

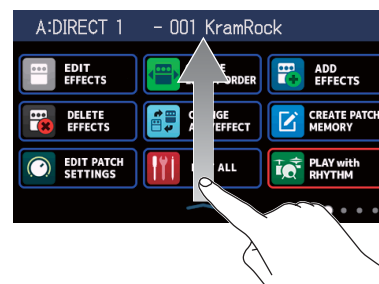

Swipe up from the bar at the bottom of the Menu Screen to return to the PLAY MODE screen.

HINT

- Even when the Menu Screen is open, the selected play mode is active and can be operated using footswitches.
- Icons can be reordered on the Menu Screen by dragging them (moving them left, right, up and down while touching them).

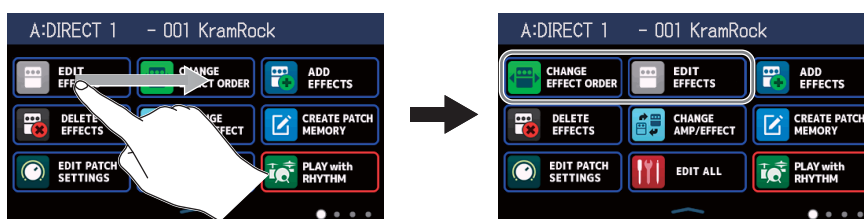

Using the function screens

Touch and drag to operate.

Touch an item to select it.

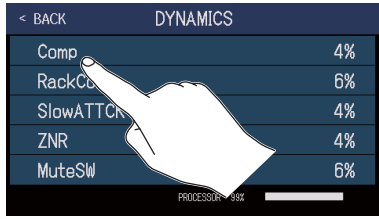

Drag an item to move or adjust it (slide finger left, right, up or down).

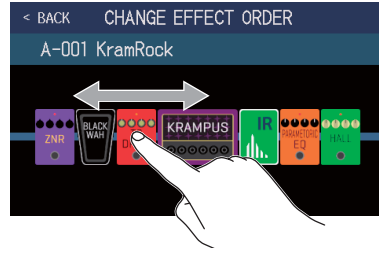

■ Returning to the previous screen

When **< BACK** appears at the top left of the touchscreen, touch it to return to the previous screen.

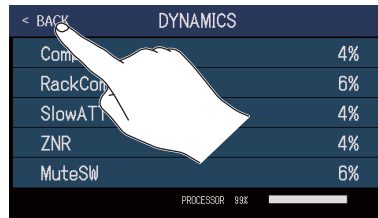

■ Scrolling through lists

A scrollbar will appear at the right edge when a list has more items than can be shown on the screen. The items shown can be scrolled by dragging up and down on the touchscreen.

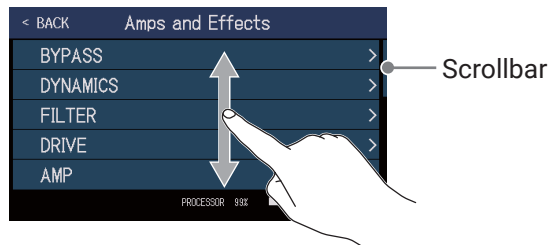

Functions of parts

■ Top

- ① PLAY MODE selection section ② Parameter knobs ③ Touchscreen ④ Expression pedal

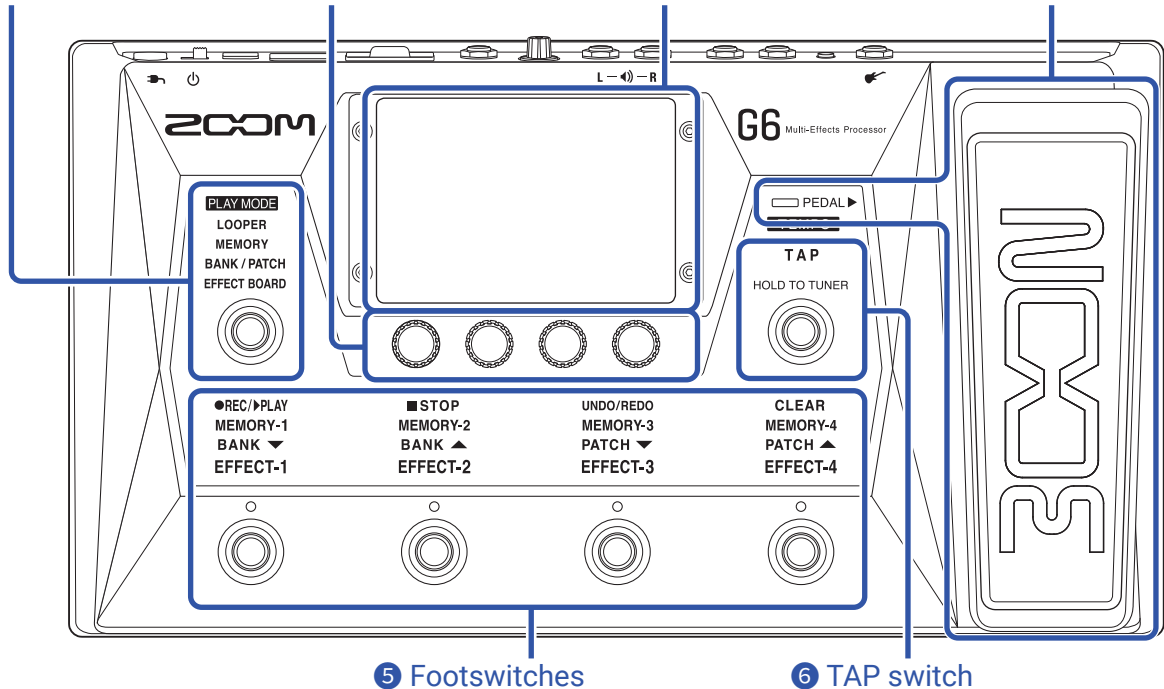

① PLAY MODE selection section

Use this to select the **G6** play mode. (The selected mode lights.)
For details about play modes, see [“PLAY MODE overview” on page 7.](#)

② Parameter knobs

Use these to adjust effect parameters and to make various settings.

③ Touchscreen

Operate the touchscreen to select and set patch memories as well as to make **G6** settings, for example.
For details about operation procedures, see [“Using the touchscreen” on page 8.](#)

④ Expression pedal

Use the expression pedal to adjust the volume or a wah effect, for example. Press the front of the pedal to turn the pedal effect on/off. (PEDAL ► lights when on.)

⑤ Footswitches

Use these to select patch memories and banks, turn effects on and off, and operate the looper.
The functions that can be controlled by the footswitches light.

⑥ TAP switch

Tap this to adjust the tempo. Press and hold to use the tuner.

■ Back

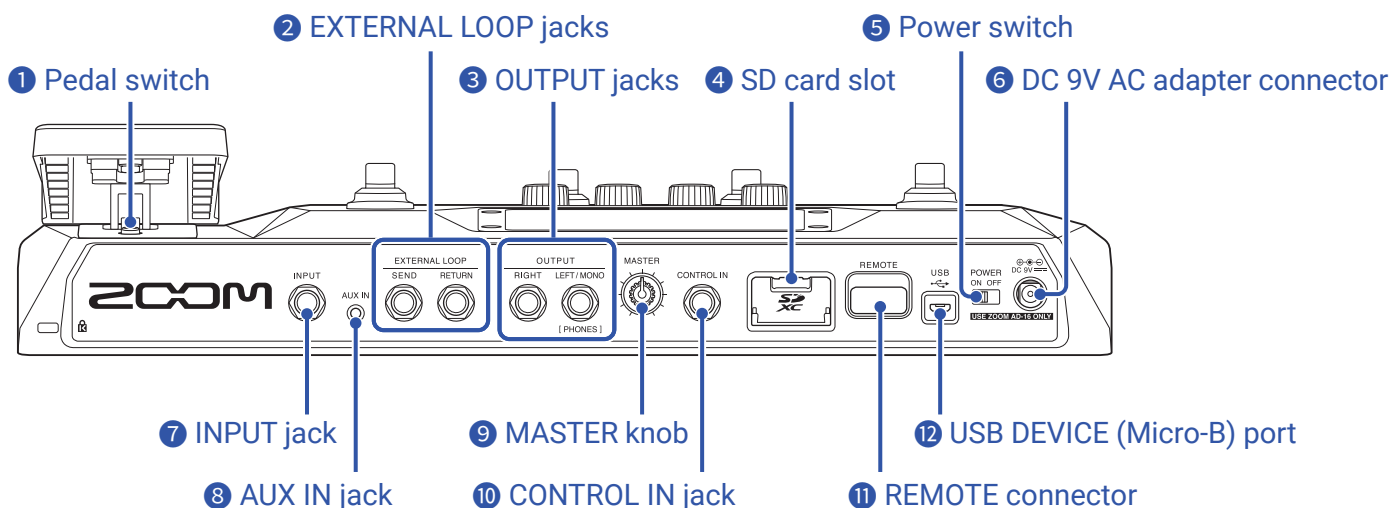

1 Pedal switch

This turns the expression pedal effect on/off.

2 EXTERNAL LOOP jacks

An external effect can be connected here.

- Connect the SEND jack to the input jack of the external effect.
- Connect the RETURN jack to the output jack of the external effect.

3 OUTPUT jacks

Connect a guitar amp, monitor speakers or headphones here.

- RIGHT jack: Connect this to the right channel input jack of another device when using stereo output.
- LEFT/MONO [PHONES] jack: Connect this to a guitar amp or headphones. Connect this to the left channel input jack of another device when using stereo output.

4 SD card slot

Cards that conform to SD, SDHC or SDXC specifications are supported.

Use the **G6** to format the SD card. (→ [“Formatting SD cards” on page 101](#))

5 Power switch

This turns the power ON/OFF.

6 DC 9V AC adapter connector

Connect the dedicated AC adapter (ZOOM AD-16) here.

7 INPUT jack

Connect a guitar here.

8 AUX IN jack

Connect a portable music player or similar device here.

9 MASTER knob

Use this to adjust the **G6** volume.

10 CONTROL IN jack

Connect an expression pedal (ZOOM FP02M) here, and use it to adjust a pedal effect.

11 REMOTE connector

Connect a ZOOM BTA-1 or other dedicated wireless adapter here.

This enables wireless control of the **G6** from an iPhone/iPad using the iOS/iPadOS Handy Guitar Lab app.

12 USB (Micro-B) port











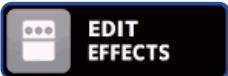

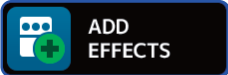











Connect a computer here.

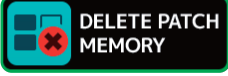
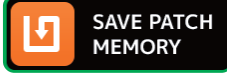



The **G6** can be used as an audio interface, and it can be controlled using Guitar Lab.

The **G6** can also be used as a card reader.

Menu Screen

This list introduces the functions of the icons shown on the Menu Screen.

Icon	Explanation	Icon	Explanation
 EDIT EFFECTS	Adjust effect parameters. (→ page 44)	 CHANGE EFFECT ORDER	Change the order of effects in patch memories. (→ page 46)
 ADD EFFECTS	Add effects to patch memories. (→ page 47)	 DELETE EFFECTS	Remove effects from patch memories. (→ page 49)
 CHANGE AMP/EFFECT	Change the effects and amps in patch memories. (→ page 41)	 CREATE PATCH MEMORY	Create patch memories. (→ page 60)
 EDIT PATCH SETTINGS	Set patch memory names and levels. (→ page 53 , page 54)	 EDIT ALL	Edit all patch memory settings. (→ page 50)
 PLAY with RHYTHM	Use the rhythm function. (→ page 77)	 USE SEND/RETURN	Make send/return settings. (→ page 84)
 USE IR	Use impulse responses (IR). (→ page 86)	 IMPORT IR	Load impulse response (IR) data. (→ page 87)
 CREATE BANK	Create banks. (→ page 66)	 CHANGE BANK ORDER	Change the order of banks. (→ page 63)
 CHANGE PATCH MEMORY ORDER	Change the order of patch memories. (→ page 58)	 DELETE BANK	Delete banks. (→ page 64)
 DELETE PATCH MEMORY	Delete patch memories. (→ page 59)	 SAVE PATCH MEMORY	Save patch memories. (→ page 56)
 SET SYSTEM SETTINGS	Change and check system settings. Manage SD cards. (→ page 94 , page 97 , page 100)	 SET TEMPO	Set the tempo used for the effects, rhythms and looper. (→ page 55)
 SET USB AUDIO	Make USB audio settings. (→ page 91)	 SET AUTO SAVE	Turn the automatic saving function on/off. (→ page 94)
 SET POWER/DISPLAY	Adjust the touchscreen brightness and turn ECO mode on/off. (→ page 95 , page 96)	 SET PEDAL	Make specific pedal settings. (→ page 70 , page 72)
 SET TUNER	Make specific tuner settings. (→ page 75)	 USE TUNER	Use the tuner. (→ page 74)

Icon	Explanation	Icon	Explanation
	Adjust the tone of the output sound. (→ page 20)		Show patch memory names in large characters for selection on the touchscreen. (→ page 23)
	Show the effects used in the patch memory on the touchscreen. (→ page 21)		Use the footswitches to select the four patch memories in the bank. (→ page 25)
	Use the looper. (→ page 27)		

HINT

Icons can be reordered on the Menu Screen by dragging them (moving them left, right, up and down while touching them).

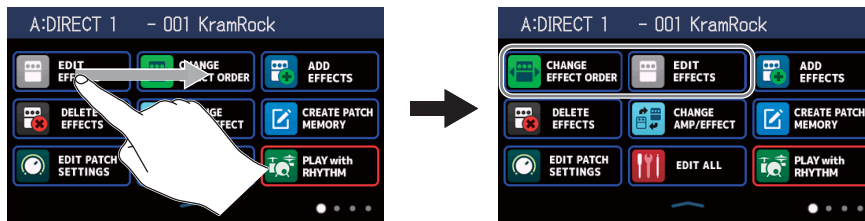

Connecting

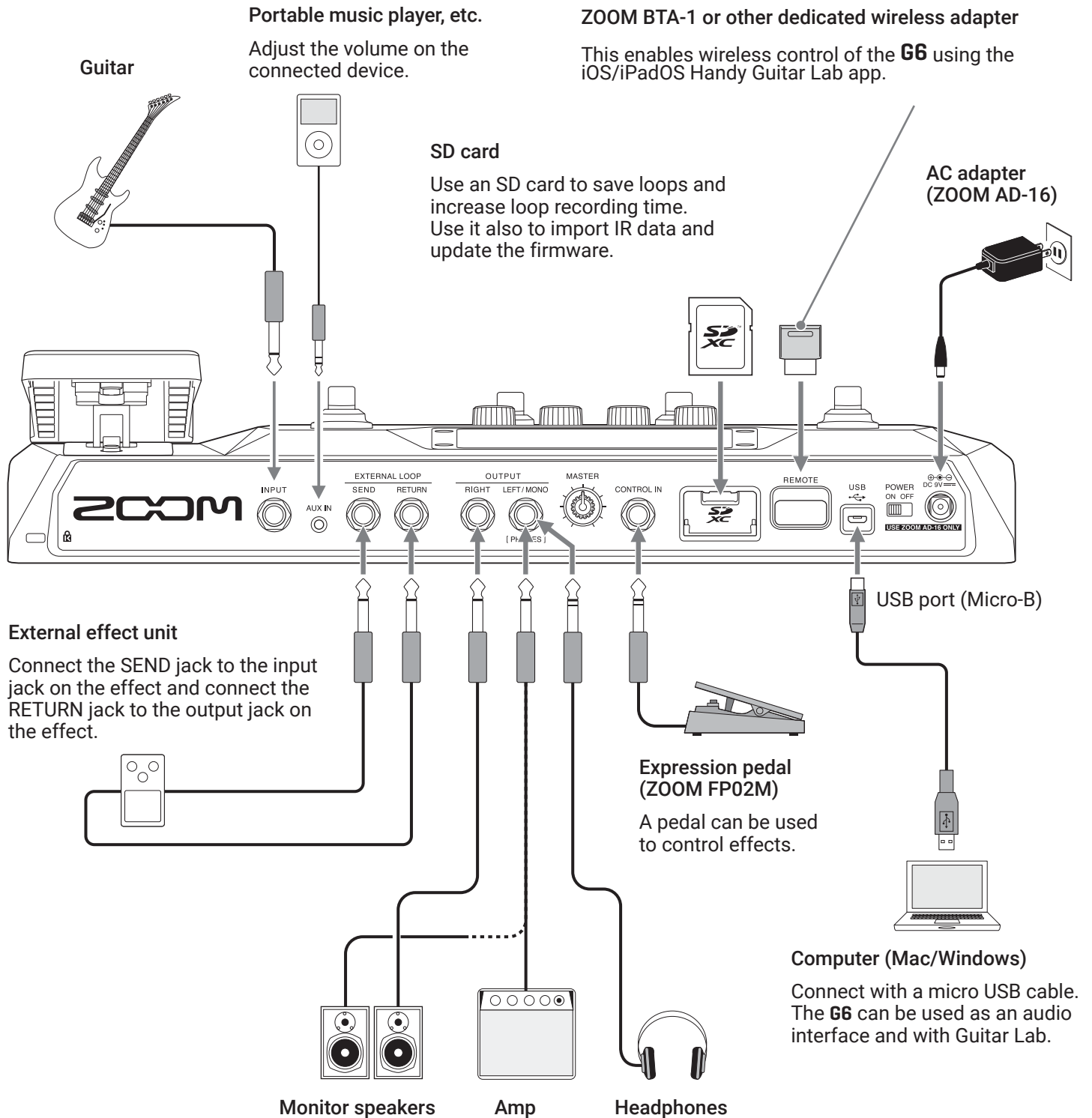

HINT

- The Guitar Lab computer app can be used to manage patch memories and to edit and add effects. Guitar Lab can be downloaded from the ZOOM website (zoomcorp.com).
- The **G6** can be controlled remotely using the Handy Guitar Lab iOS/iPadOS app. Handy Guitar Lab can be downloaded from the App Store.

Inserting SD cards

Inserting an SD card in the **G6** makes the following possible.

- Loops can be saved and loop recording time increased.
- Impulse response data, including data you already have and from third parties, can be loaded and used.
- The **G6** can be used as a card reader.
- The firmware can be updated.

1. When the power is off, open the SD card slot cover, and insert an SD card all the way into the slot.
To remove an SD card, push it further into the slot and then pull it out.

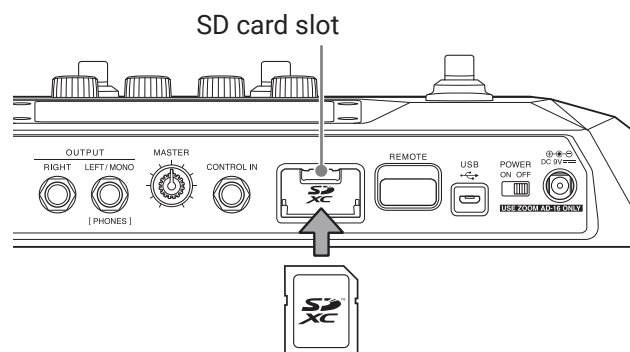

NOTE

- Cards that conform to SD, SDHC or SDXC specifications are supported.
- Disable write-protection on the SD card before inserting it.
- Inserting or removing an SD card while the power is on could result in data loss.
- When inserting an SD card, be sure to insert the correct end with the top side up as shown.
- Before using SD cards that have just been purchased or that have been formatted on a computer, they must be formatted by the **G6** (→ ["Formatting SD cards" on page 101](#)).

Turning the power on/off

Turning the power on

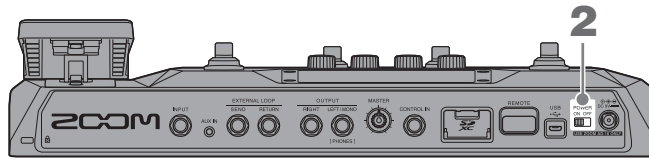

1. Minimize the volume of the amp/monitor speakers.

2. Set  to ON.

This turns the **G6** power on and opens the PLAY MODE screen (→ [page 7](#)) on the touchscreen.

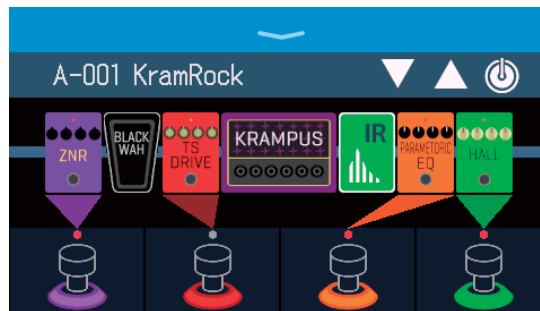

HINT

When the power is turned on, the play mode active when the power was last turned off will be reactivated.

3. Raise the volume of the amp/monitor speakers.

ECO mode overview

- By default, ECO mode is set to ON, so the power will automatically turn off if no use occurs for 10 hours.
- ECO mode can also be turned OFF. (→ [“Setting the ECO mode” on page 96](#))

Turning the power off

1. Minimize the volume of the amp/monitor speakers.

2. Set  to OFF.

The touchscreen will become blank.

Adjusting the master level

The volume output from the **G6** can be adjusted.

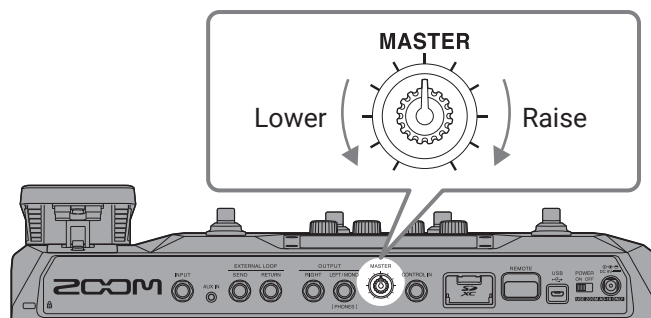



NOTE

- The setting range is $-\infty$ to +6 dB.
- When the knob is centered the setting is 0 dB.

Adjusting the master EQ

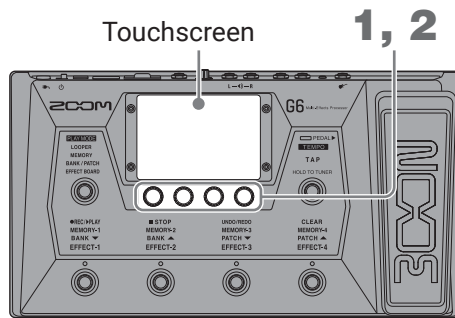
The tone of the sound output from the **G6** can be adjusted.



1. Turn  in MEMORY, BANK/PATCH or EFFECT BOARD mode.
This opens the OUTPUT EQ screen on the touchscreen.

2. Turn  to adjust output sound EQ parameters.

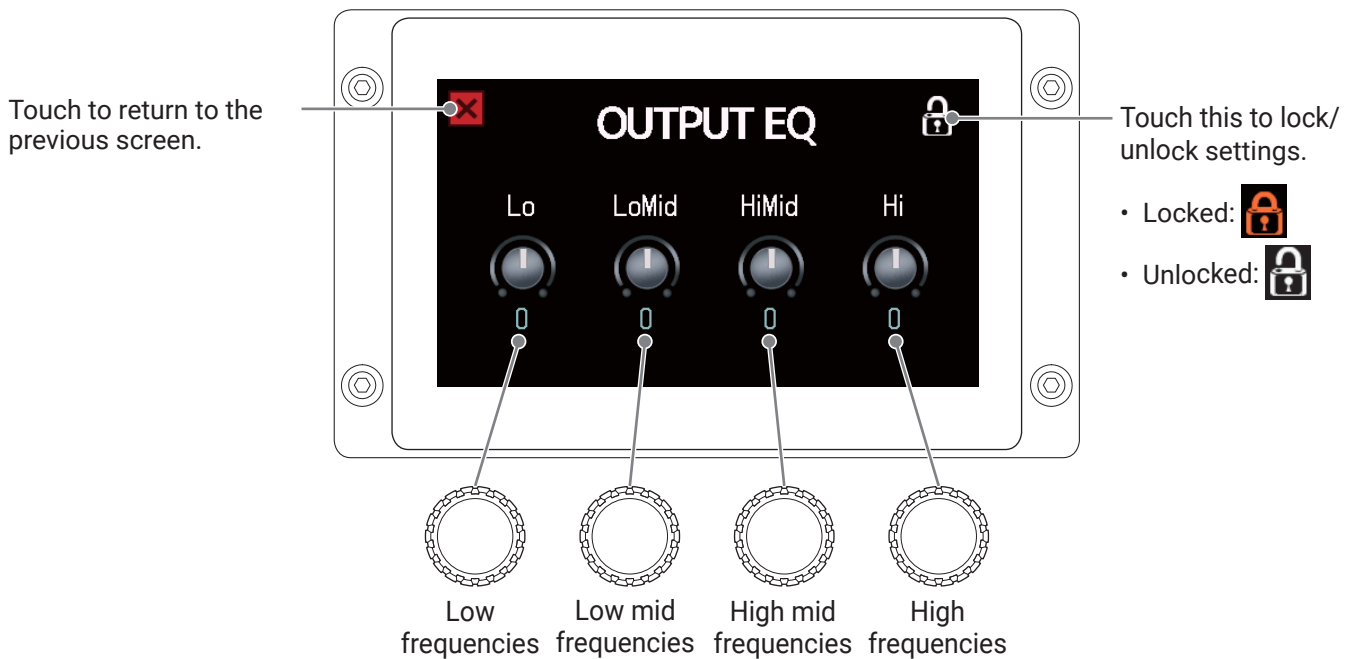

When adjustment is completed, the previous screen will reopen after a moment

HINT

Touching  on the Menu Screen will also open the OUTPUT EQ screen.

Turning effects on and off while playing

In EFFECT BOARD mode, the effects and amp used in the patch memory are shown on the touchscreen and can be turned on and off using the footswitches.

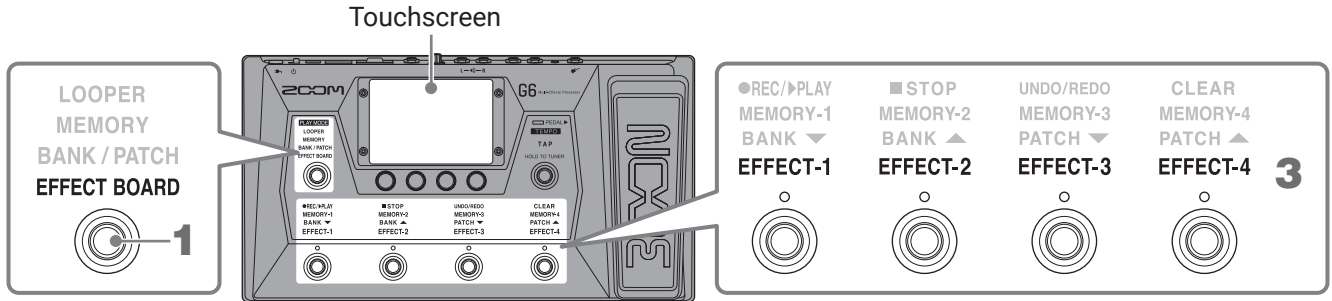

1. Press  repeatedly to select **EFFECT BOARD**.

This activates the **G6** EFFECT BOARD mode where all the effects and the amp used in the patch memory can be seen at a glance.

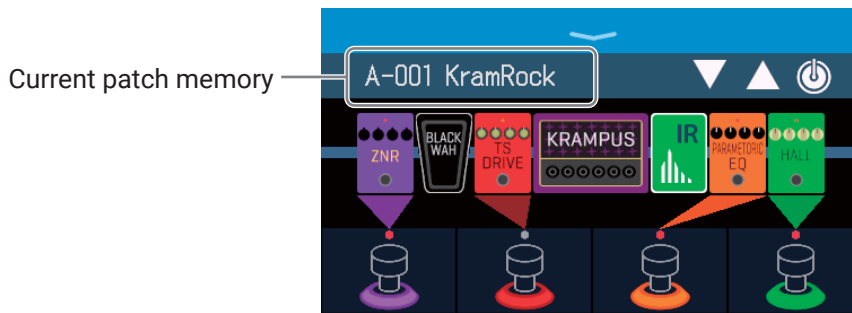

HINT

Touching  on the Menu Screen will also activate EFFECT BOARD mode.

2. Touch an effect to enable turning it on/off with a footswitch.

The touched effect is assigned to a footswitch.

Touch again to remove the assignment.

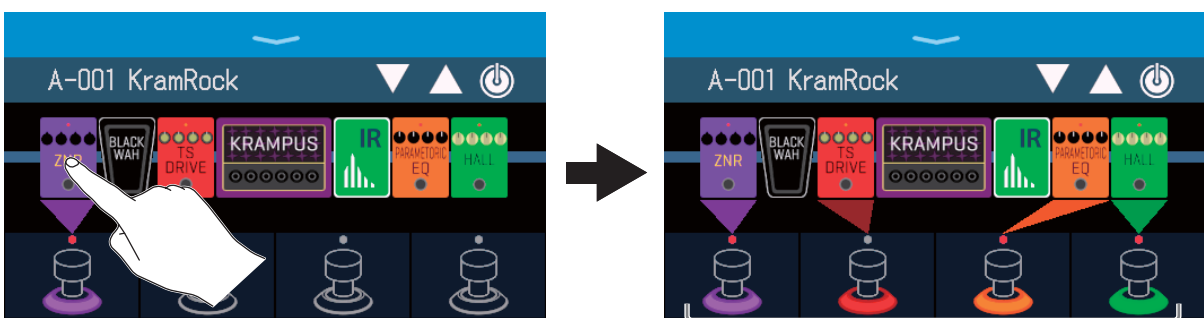

When effects are assigned, the color at the base of the footswitch changes color according to the category.

3. Press footswitches to turn effects on/off.

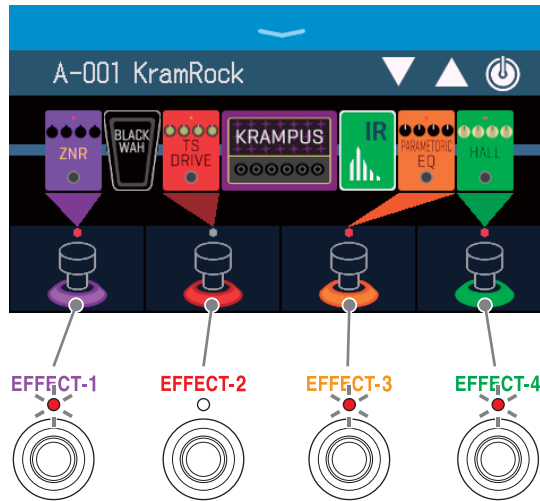

The indicators light when effects are on.

The footswitch display colors depend on the effect category.

NOTE

- Regardless of the order that the effects are touched, they are assigned to the footswitches from the left.
- After effects have been assigned to all footswitches, touching other effects will not assign them.
- Some effects assign special functions to footswitches. (This includes effects that turn on only while the footswitch is being pressed, for example.) Special functions can be selected on the EDIT EFFECTS screen. (→ [“Footswitch special functions” on page 45](#))

HINT

The following operations are also possible on the touchscreen.

Select the previous patch memory.

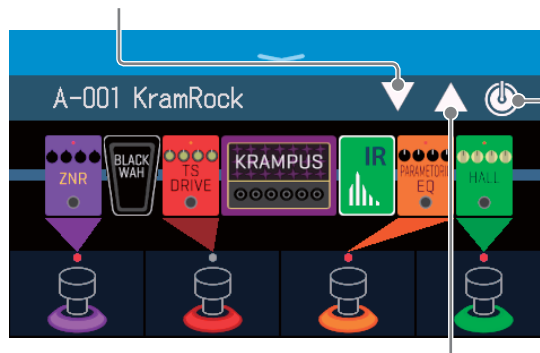



Touch this to show  on the effects. This icon can be touched to open the EDIT EFFECTS screen. (→ [“Adjusting effects” on page 44](#))

Select the next patch memory.

Switching banks and patch memories while playing

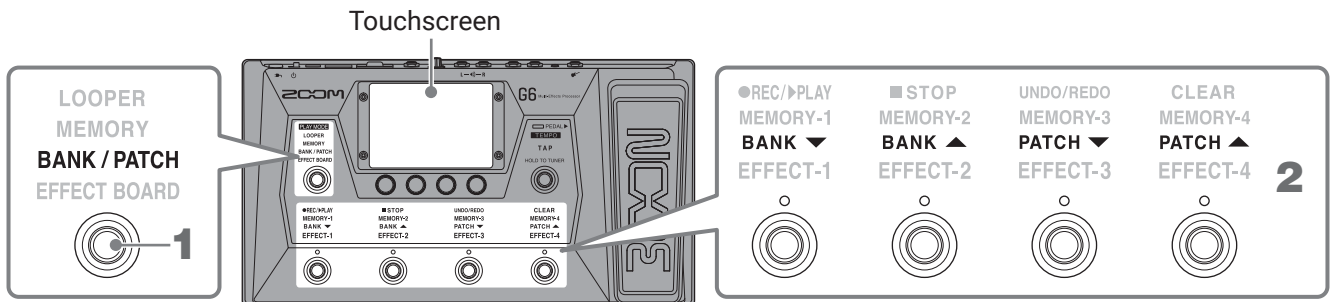
Bank and patch memory names can be shown with large characters and selected on the touchscreen.



1. Press  repeatedly to select **BANK / PATCH**.

This activates the **G6** BANK/PATCH mode, and the name of the selected bank and patch memory are shown in large letters for easy confirmation.

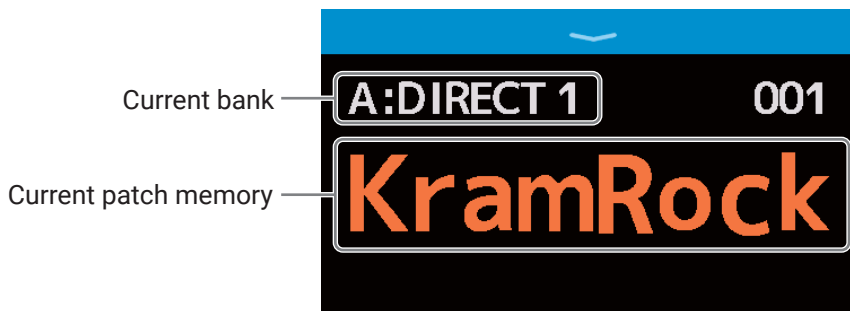

HINT

Touching  on the Menu Screen will also activate BANK/PATCH mode.

2. Swipe up or down on the touchscreen to select patch memories.

- Select the next patch memory.



- Select the previous patch memory.

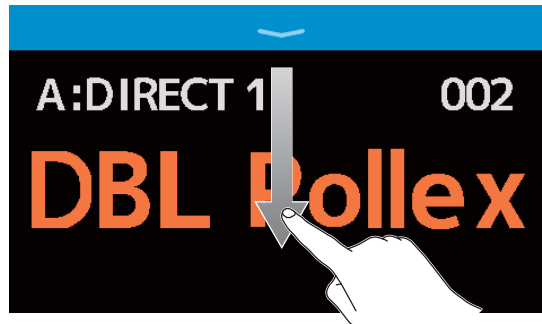

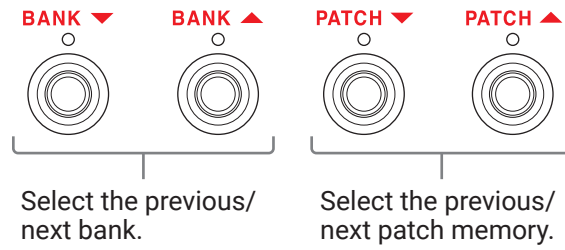

The footswitches can also be used to select banks and patch memories.

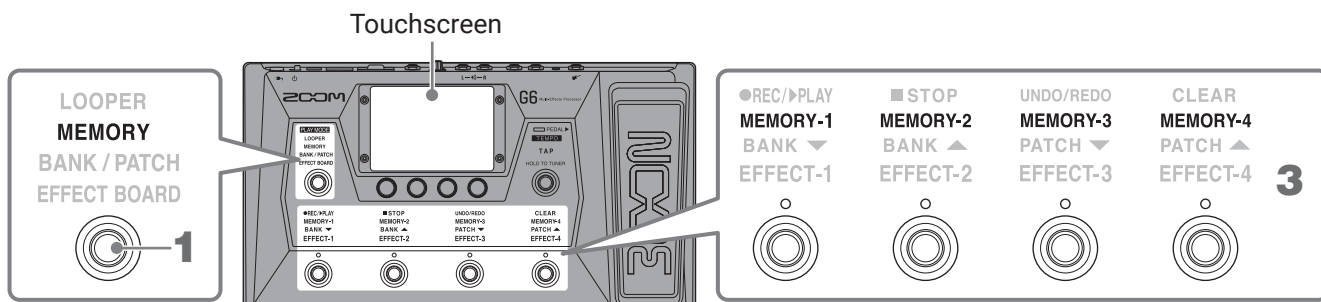

Switching patch memories in one bank while playing

A bank can be shown on the touchscreen, and the four patch memories in it can be selected with one touch.



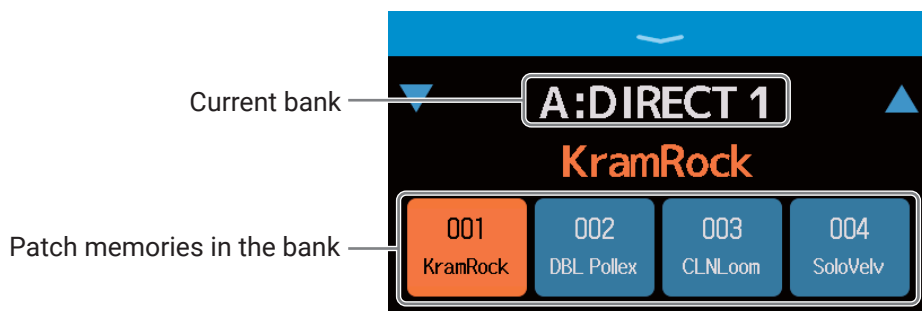

1. Press  repeatedly to select **MEMORY**.

This activates the **G6 MEMORY** mode in which the name of the selected bank and the four patch memories can be checked.



HINT

Touching  on the Menu Screen will also activate MEMORY mode.

2. Touch  or  at either end of the bank name to select the desired bank.



3. Touch the desired patch memory.
The selected patch memory will be highlighted.

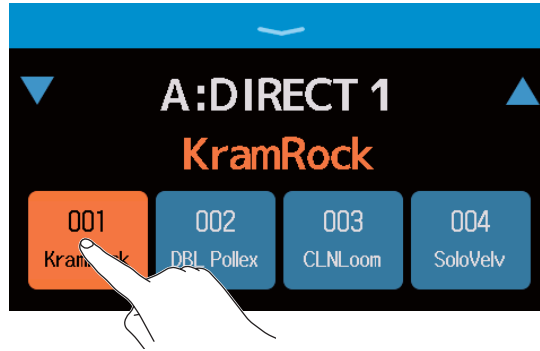

The footswitches can also be used to select patch memories directly.

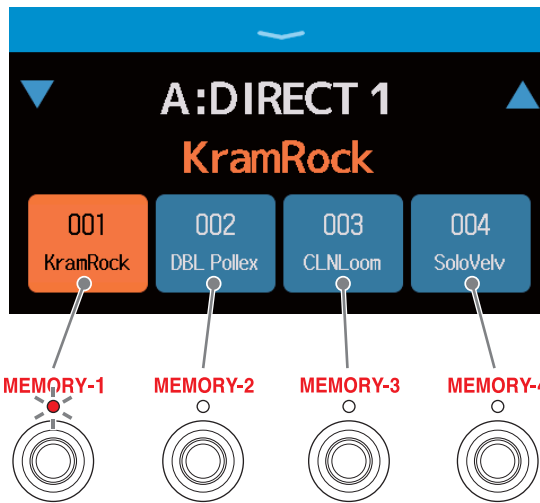

The indicator for the selected patch memory lights.

HINT

Patch memories can be dragged to reorder them.

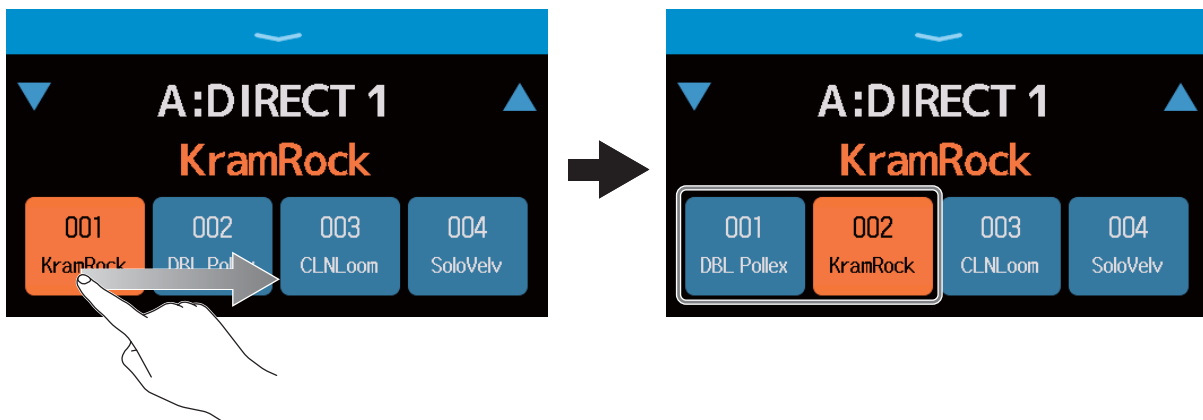

Using the looper while playing

Played phrases can be recorded to create stereo loops up to 45 seconds long.

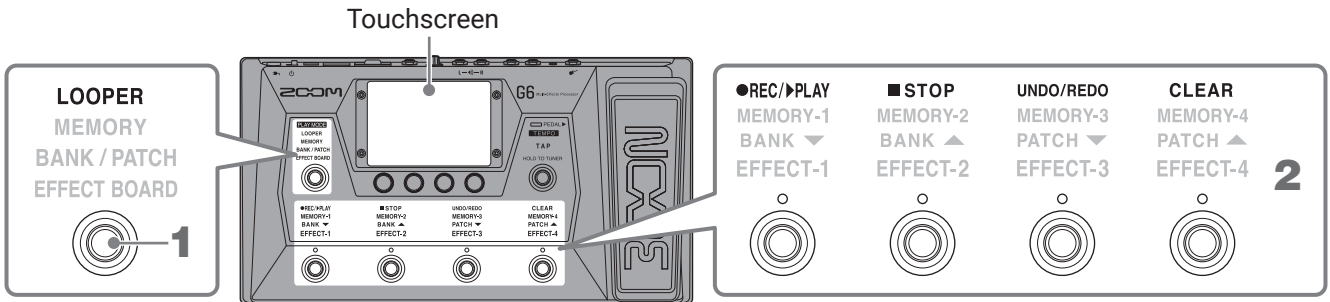

1. Press repeatedly to select **LOOPER**.

This activates the **G6** LOOPER mode, and opens the Looper Control Screen on the touchscreen.

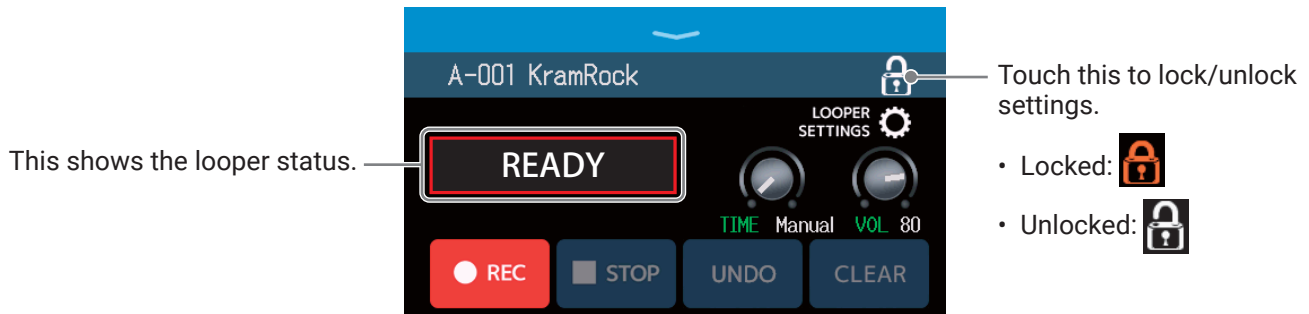

HINT

Touching on the Menu Screen will also activate LOOPER mode.

2. Use the looper.

■ Recording loops

When no loop has been recorded ("READY" shown), press or touch .

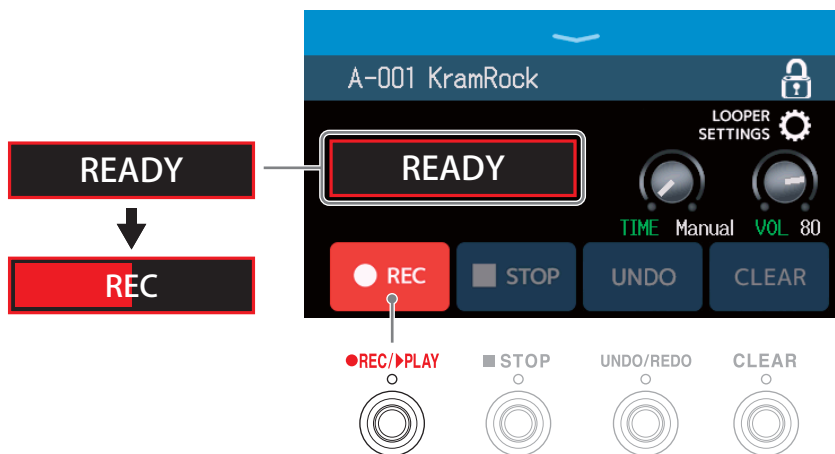

Press when recording to cancel recording.

■ Stopping recording and starting loop playback

When recording, press  or touch .

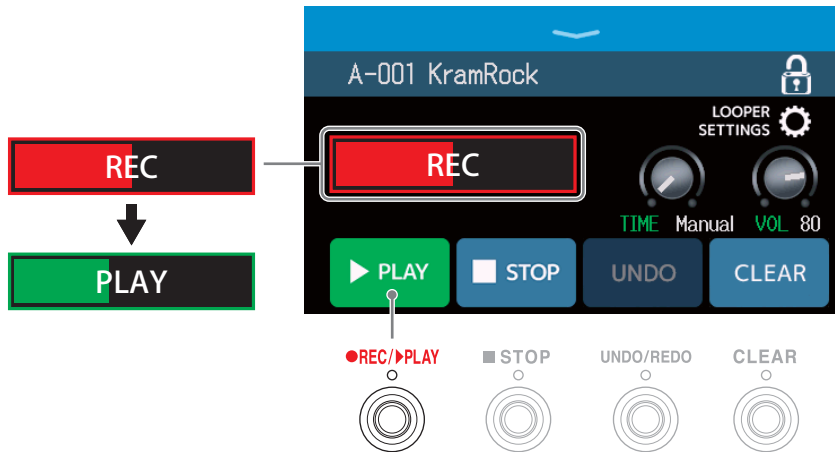

NOTE

- When the maximum recording time is reached, recording will stop and loop playback will start.
- If the recording time is set to " $\text{J} \times 1-64$ ", recording will stop and loop playback will start after the set recording time has elapsed. (→ "[Setting the recording time](#)" on page 32)

■ Stopping playback

When playing, press  or touch .

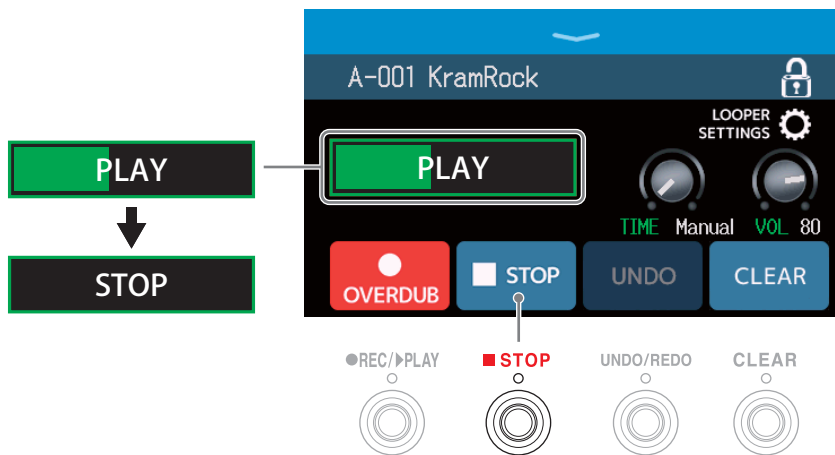

Starting loop playback of the recorded phrase

When stopped, press  or touch .

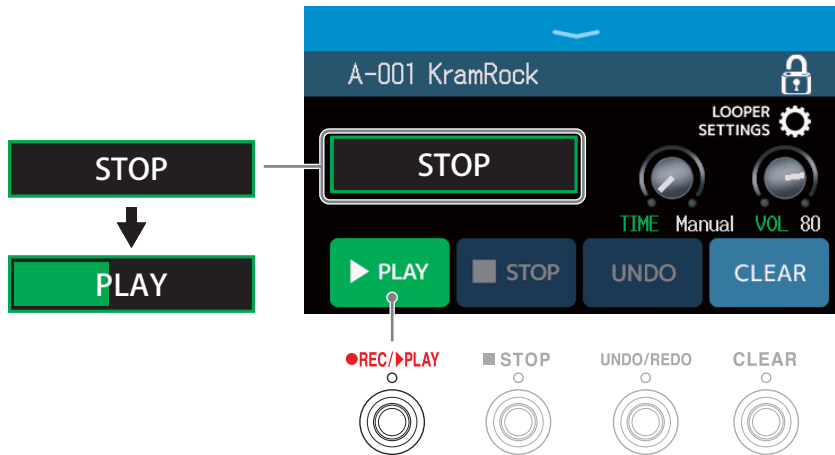

Adding performances to recorded loops (overdubbing)

When playing, press  or touch .

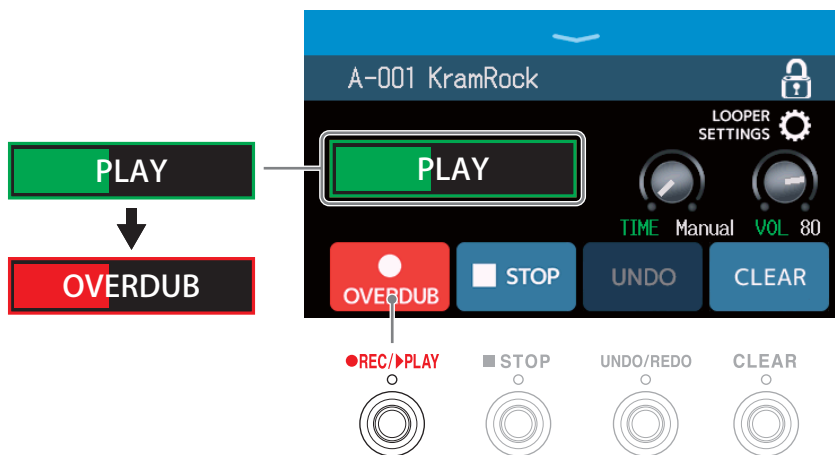

When the end of the loop is reached, loop playback will continue from the beginning, and overdubbing can be repeated.

When overdubbing, press  to stop overdubbing, but continue loop playback.

Erasing the last overdubbed phrase (UNDO function)

Press  or touch **UNDO**.



Restoring an undone overdub (REDO function)

Press  or touch **REDO**.



Clearing loops

Press  or touch **CLEAR**.



This clears the recorded loop.

Notes about the looper tempo

- The looper tempo is also used by effects and rhythms.
- The tempo can be set as explained in [“Adjusting the master tempo” on page 55](#) and [“Adjusting the tempo” on page 80](#).
- Changing the tempo will delete the recorded data.

NOTE

- If the pre-count function is ON (→ [“Setting the precount” on page 79](#)), recording will start after the pre-count.
- Sound input through the AUX IN jack will not be recorded.
- See [“Setting the looper” on page 32](#) for recording time, volume and other settings.

HINT

- Using an SD card, loops can be recorded for longer times and saved. Moreover, loops on the SD card can be recalled for playback and overdubbing. (→ [“Using SD cards” on page 37](#))
- During rhythm playback (→ [page 77](#)), quantization is enabled so even if the recording ending time is not exact, the loop will automatically be adjusted so that loop playback stays in time.
- Different play modes can be selected and the Menu Screen can be opened during loop playback. This allows patch memories to be selected and rhythms to be used, for example, while the loop continues to play.

To stop loop playback when doing other operations, press  repeatedly and select **LOOPER** or touch

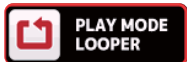

on the Menu Screen. Then, stop playback.

When other play mode screens are open, the looper playback status is shown at the top left.

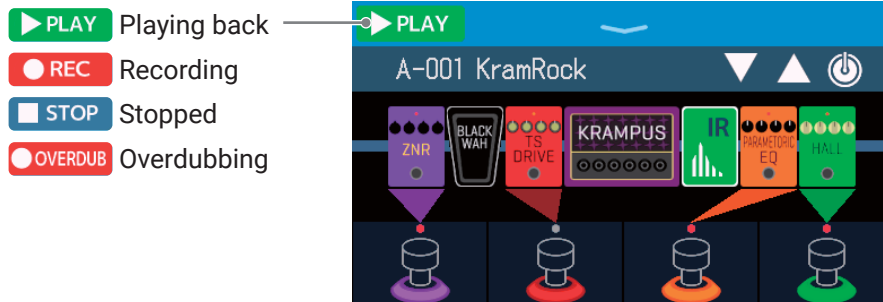

Setting the looper

Various looper settings can be made.

Setting the recording time

The length of the recorded phrase can be set.

1. Turn  or drag the TIME knob up or down on the Looper Control Screen (→ [page 27](#)).

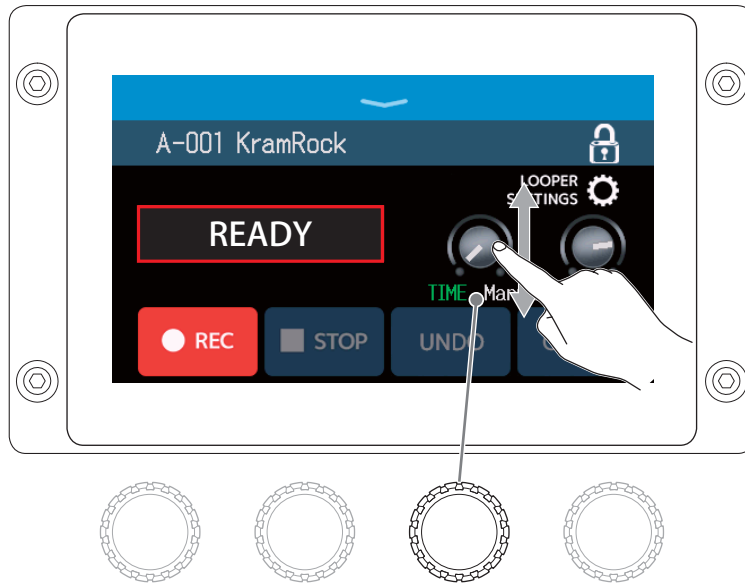

Setting	Explanation
MANUAL	Recording will continue until stopped manually or the maximum recording time is reached.
♩ × 1–64	Set the value to 1–64 quarter notes. The actual recording time depends on the BPM (tempo) setting (→ “Adjusting the master tempo” on page 55). The recording time (seconds) = $60 \div \text{BPM} \times \text{quarter notes}$. When the set recording time is reached, recording will stop and loop playback will start.

NOTE

- The setting options include MANUAL and 1–64 quarter notes.
- The recording time for the looper is 2–45 seconds when stereo and 2–90 seconds when mono. To switch between stereo and mono, see [“Setting to stereo or mono” on page 34](#).
- Settings that would exceed the maximum recording time will be adjusted automatically.
- Changing the recording time will delete the recorded data.

Adjusting the volume

The looper volume can be adjusted.

1. Turn  or drag the VOL knob up or down on the Looper Control Screen (→ [page 27](#)).

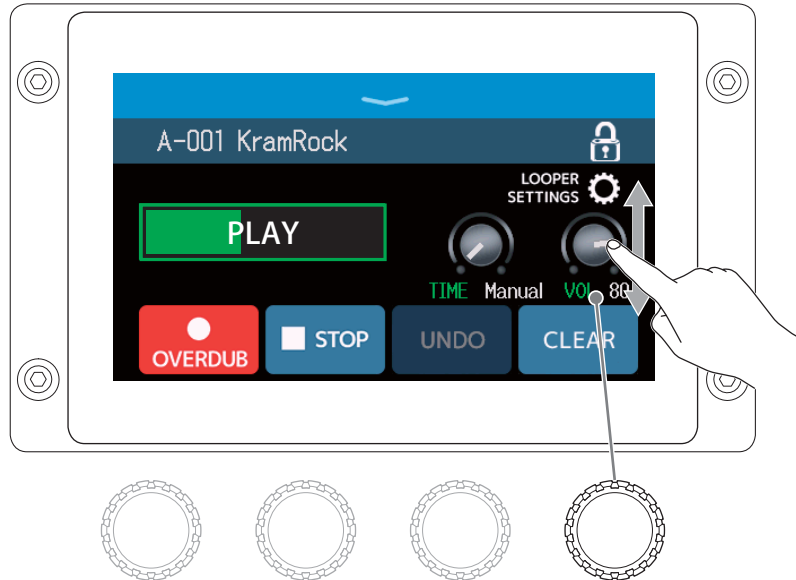

HINT

This can be set from 0 to 100.

Setting to stereo or mono

Loops can be recorded in stereo or mono.

1. Touch LOOPER SETTINGS on the Looper Control Screen (→ [page 27](#)).



2. Touch the desired setting.

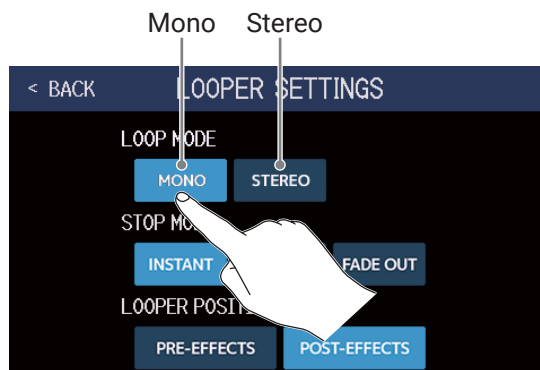

NOTE

- The recording time for the looper is 2–45 seconds when stereo and 2–90 seconds when mono.
- When using an SD card (→ [page 37](#)), the STEREO/MONO setting cannot be changed. It is fixed to STEREO.

Setting the STOP MODE

How the looper behaves when stopped can be set.

1. Touch LOOPER SETTINGS on the Looper Control Screen (→ [page 27](#)).

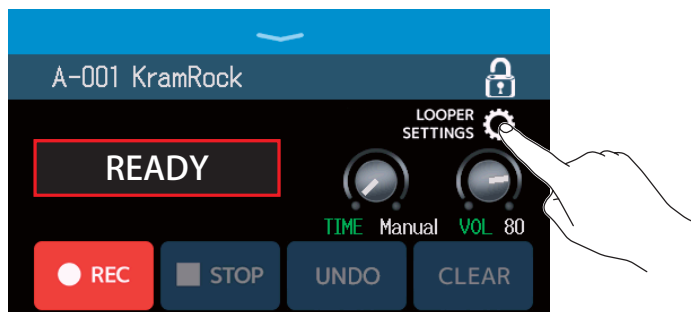

2. Touch the desired STOP MODE.

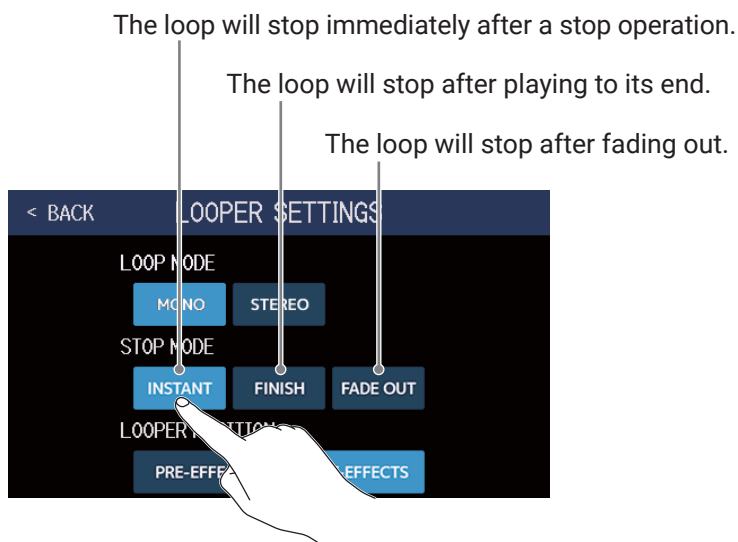

Changing the looper position

The looper position can be changed.

1. Touch LOOPER SETTINGS on the Looper Control Screen (→ [page 27](#)).

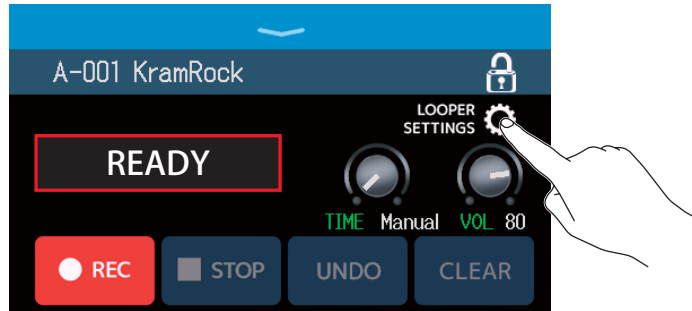

2. Touch the desired looper position.

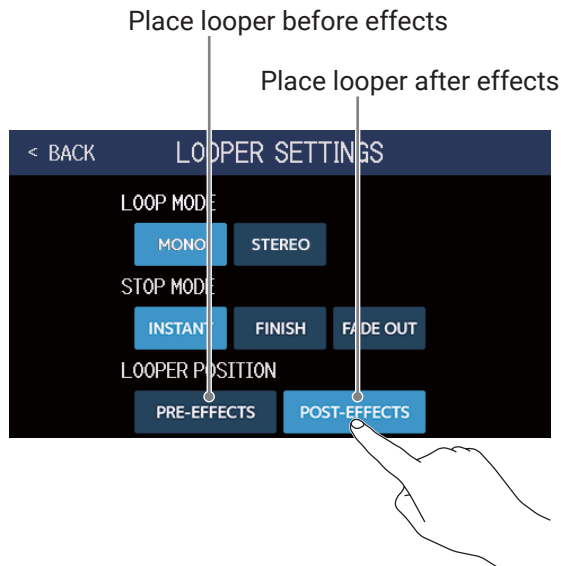

HINT

By placing the looper before the effects, the sound of a looped performance can be altered to craft the sound without continuing to play.

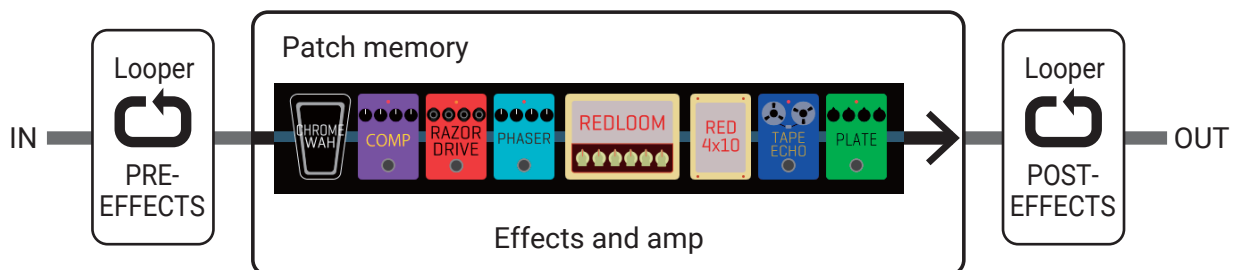

Using SD cards

By loading an SD card in the **G6**, loop recording time can be increased and loops can be saved. Other audio files can also be loaded and used as loops.

Creating a loop and saving it to an SD card

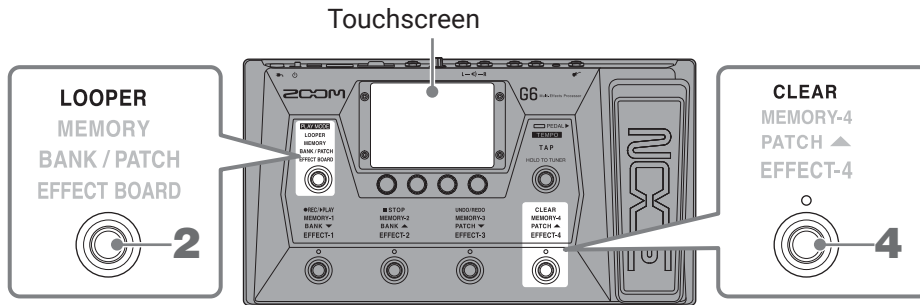

1. Insert an SD card (→ [“Inserting SD cards” on page 17](#)).

2. Press repeatedly and select **LOOPER**, or touch on the Menu Screen.

This activates the **G6** LOOPER mode, and opens the Looper Control Screen on the touchscreen.

This appears when an SD card is loaded.

“New Loop File” appears, indicating that a new loop can be created. The name of the selected loop will be shown when a loop is being created or has been selected.

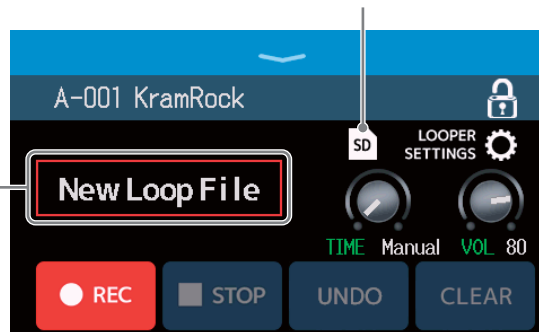

3. Create a loop.

Follow the procedures in step 2 of [“Using the looper while playing” on page 27](#) to create a loop.

When loop recording starts, the name of the loop is shown. The loop that is being created will be saved with the name that is shown.



NOTE

- Loops will be created and named “LOOPER_001”. The “xxx” in the loop name is a sequential number.
- When an SD card is loaded, loops cannot be deleted. Use a computer or other device to delete saved loops on an SD card.
- When an SD card is loaded, the looper status will not be shown on the touchscreen.
- Changing the tempo while recording will delete the data being recorded.
- When an SD card is loaded, the recording time is from 2 seconds to 2 hours.

4. When done creating a loop, press  or touch **CLEAR**.

The created loop will be saved on the SD card.

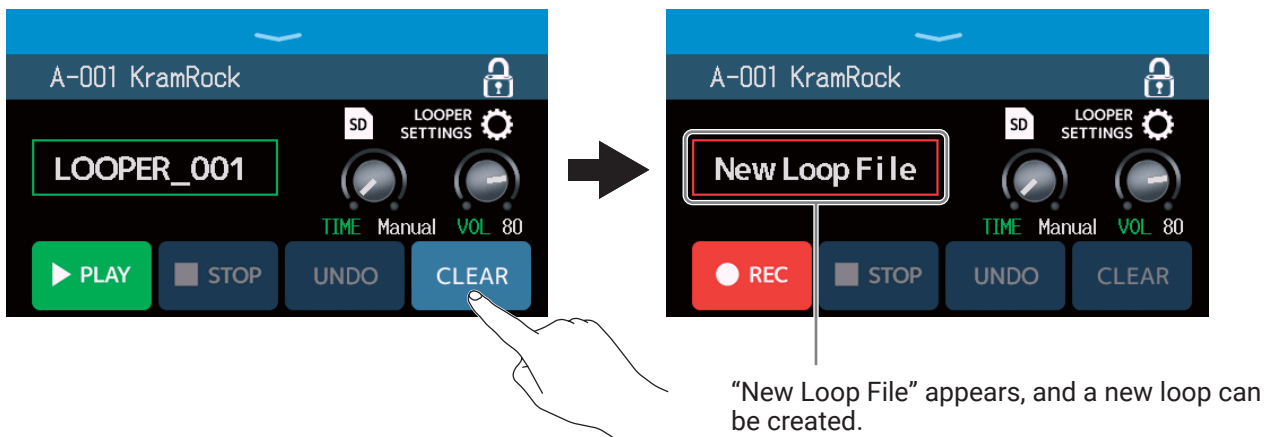

NOTE

The settings made in [“Setting the looper” on page 32](#) cannot be saved separately for different loops. The same settings are used for all loops.

Selecting loops saved on SD cards

1. Touch  on the Looper Control Screen (→ [page 27](#)).

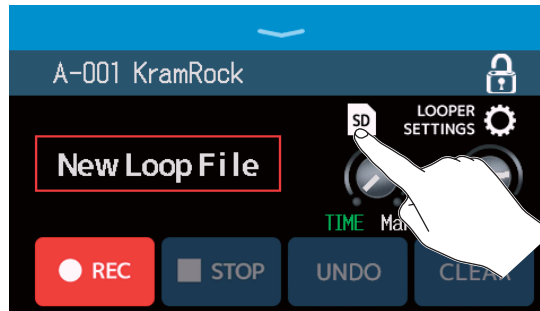

2. Touch a loop to select it.

The selected loop appears on the Looper Control Screen.

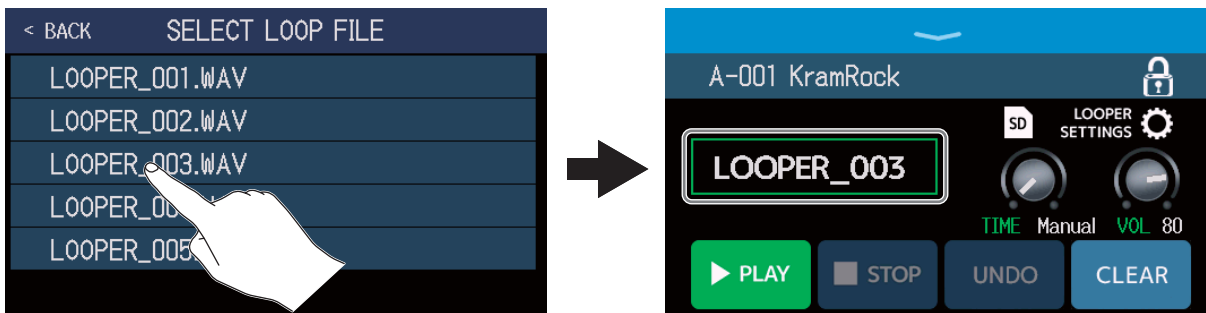

The selected loop can be played back and overdubbed.

HINT

To load your own audio files and use them as loops, copy them to the "G6_Looper" folder on the SD card in advance. (→ ["G6 folder and file structure" on page 104](#))



The "G6_Looper" folder is created at the top level of an SD card when it is formatted by the G6. (→ ["Formatting SD cards" on page 101](#))

Audio files in the following format can be loaded.

- Sampling frequency: 44.1 kHz
- Bit rate: 16-bit
- Stereo

Adjusting effects

Saving changes

- When the AUTOSAVE function is ON, changes to patch memories will be automatically saved. (This function is ON by default.) (→ [“Setting the AUTOSAVE function” on page 94](#))
- Patch memories will not be saved automatically if the AUTOSAVE function is OFF. When the content of a patch memory has been changed,  will appear at the top right of the touchscreen, showing that it is different from the saved settings.
Touch  to open the screen for saving patch memories, and save it as necessary. (→ [“Saving patch memories” on page 56](#))

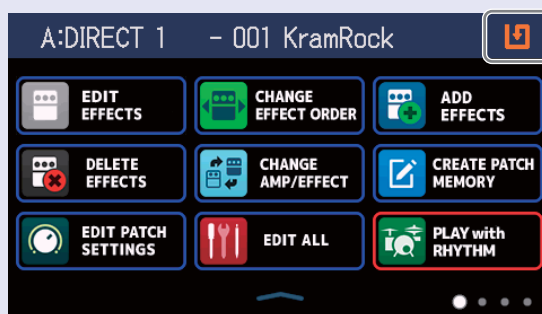

Turning effects on and off

Individual effects in patch memories can be turned on and off.

1. Select the patch memory that has an effect you want to turn on/off.
2. Touch  on the Menu Screen.
3. Touch the indicator above an effect to turn it on/off.

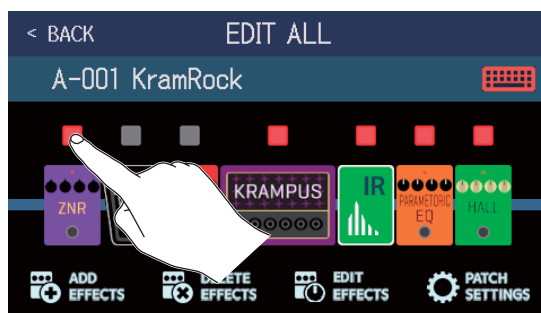

The indicator appears lit red when on and unlit when off.

HINT

Using , patch memory editing operations can be conducted on a single screen.
(→ [“Making all settings on one screen” on page 50](#))

Replacing effects

Effects in a patch memory can be replaced with other effects as desired.

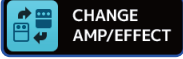
1. Select the patch memory with the effect you want to replace.
2. Touch  on the Menu Screen.
3. Touch the effect that you want to replace.

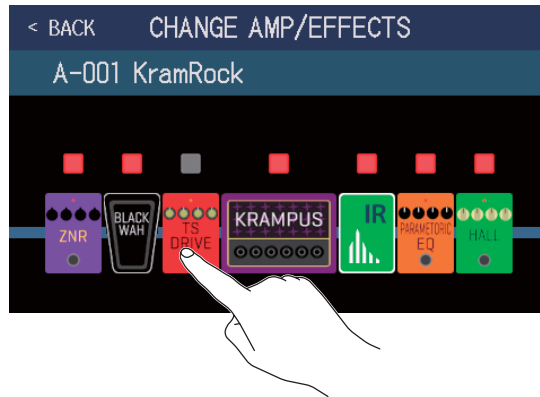

The touched effect is shown in a list.

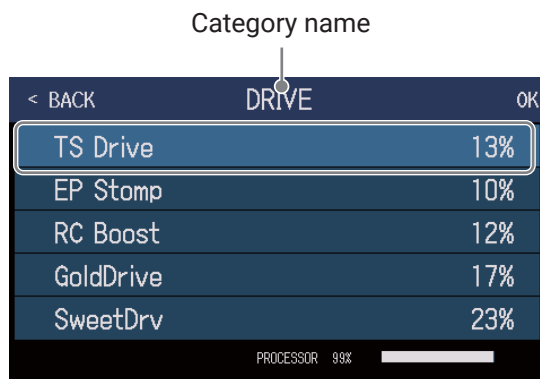

4. Skip to step 6 to select another effect in the same category.

Touch BACK to select an effect in a different category.

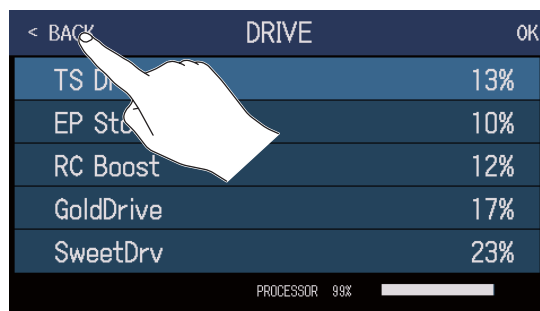

5. Touch a category to select it.

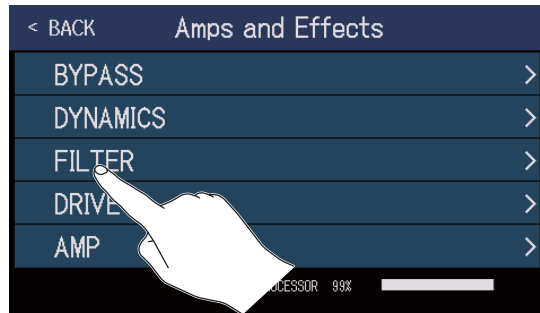

6. Touch an amp or effect to select it. Then, touch OK.

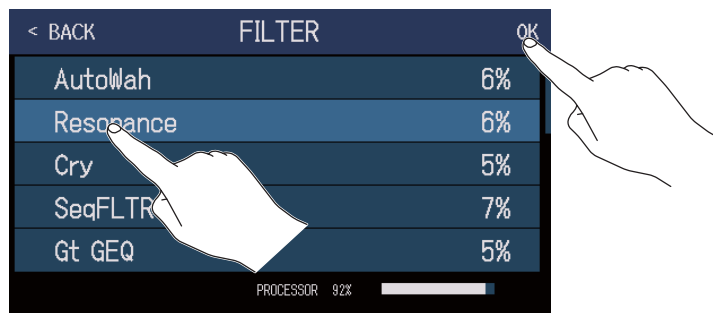

This changes it to the selected amp or effect.

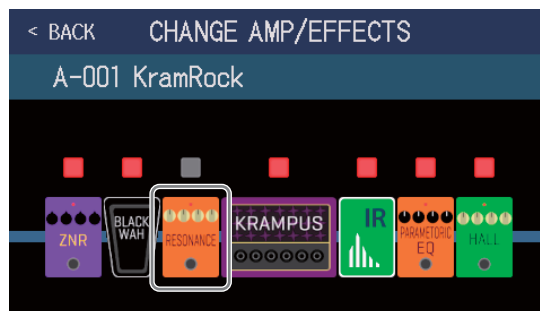

NOTE

If an effect in a patch memory has been deleted from Guitar Lab, the deleted effect will appear with  and be disabled

HINT

See Guitar Lab for the explanations of each effect.

Number of effects in patch memories

The **G6** allows you to combine up to 9 effects freely. However, you must select effects that do not cause the processor to exceed 100%.

The processing status can be checked on screens where categories and effects are selected.



Effect	Processor Usage
AutoWah	6%
Resonance	6%
Cry	5%
SeqFLTR	7%
Gt GEQ	5%

PROCESSOR 98%

Processing status

If an effect is selected that would cause the processor to exceed 100%, the effect will not be selected and the following message will appear before returning to the previous screen.

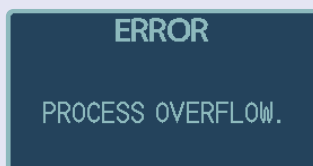

In this case, change or delete another amp or effect so the processor does not exceed 100%.

Adjusting effects

The individual effects used in patch memories can be adjusted.

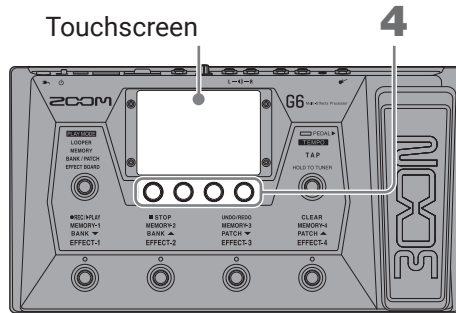

1. Select a patch memory that has an effect you want to adjust.

2. Touch  on the Menu Screen.

3. Touch the effect to adjust.

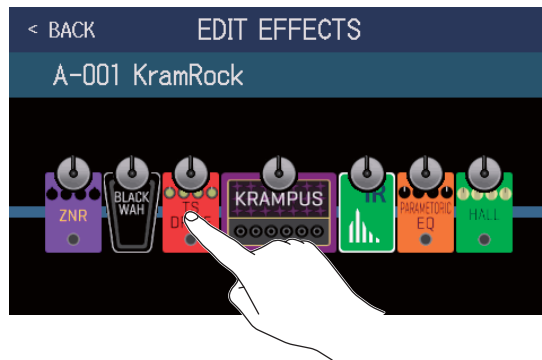

4. Turn  or drag parameter knobs up and down to change effect parameters.

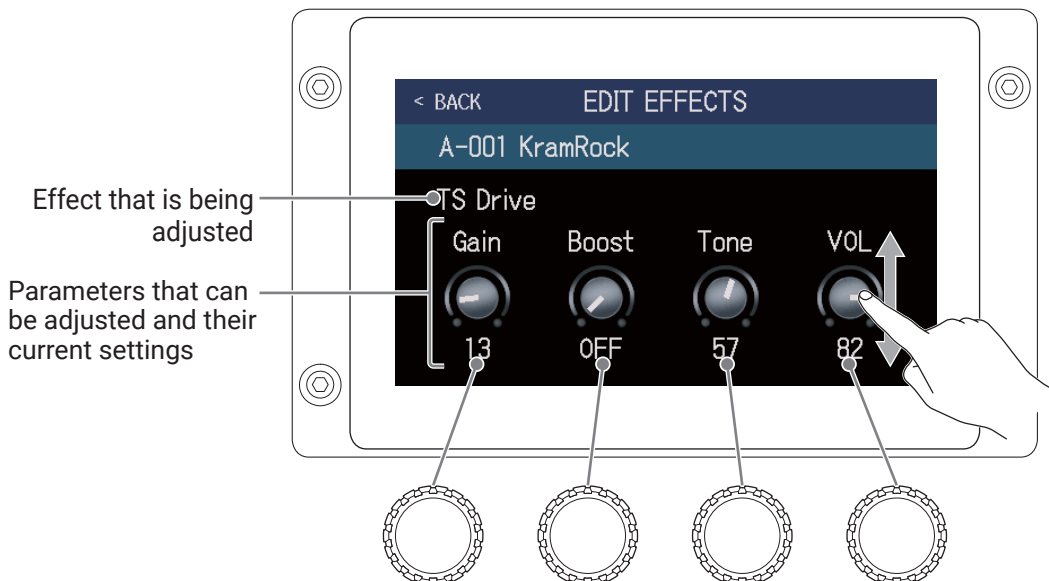

HINT



- Set Time, Rate and other effect parameters to musical notes to sync them to the tempo. (→ [“Adjusting the master tempo” on page 55](#))
- See Guitar Lab for the explanations of each effect.
- Changing effects (→ [“Replacing effects” on page 41](#))
- Adding effects (→ [“Adding effects” on page 47](#))
- Deleting effects (→ [“Deleting effects” on page 49](#))

Large effects

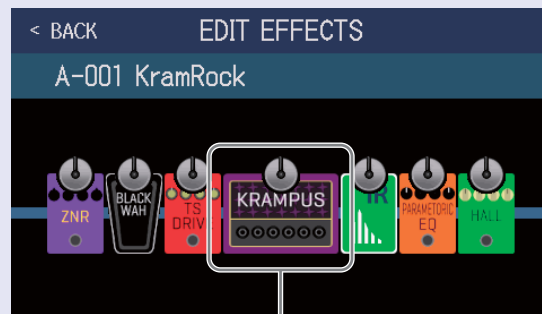
Effects that look bigger in EFFECT BOARD mode and on the EDIT EFFECTS screen are called “large effects” and use two effect spaces.



Large effect

Large effects have more parameters, so their EDIT EFFECT screens have two pages. Touch  or  at the bottom of the screen to change pages.

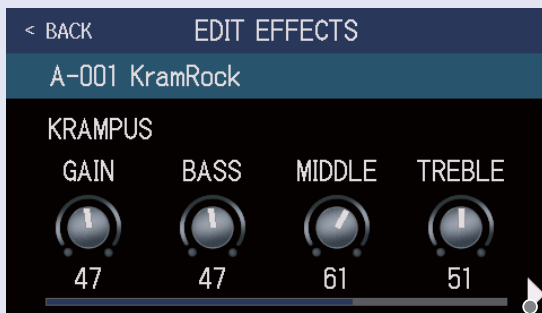

Open the next screen

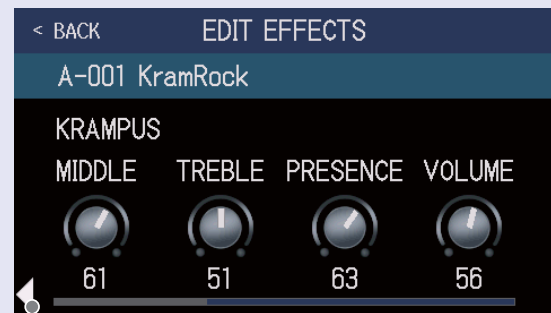

Open the previous screen

Footswitch special functions

Some effects assign special functions to footswitches, including turning the effect on only while the footswitch is being pressed. Parameters that select special functions appear on the touchscreen as dark letters on a light background.

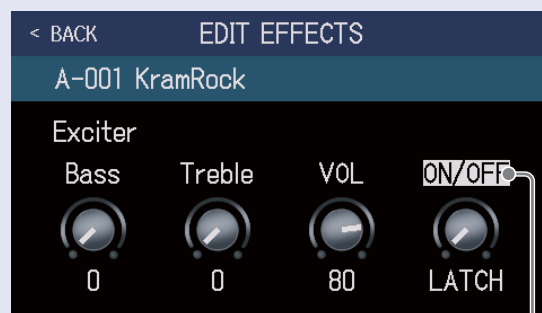

Dark on light display

Changing effect order

Effects in a patch memory can be reordered as desired.

1. Select the patch memory that you want to reorder.
2. Touch  on the Menu Screen.
3. Drag an effect icon to move it to the desired position.

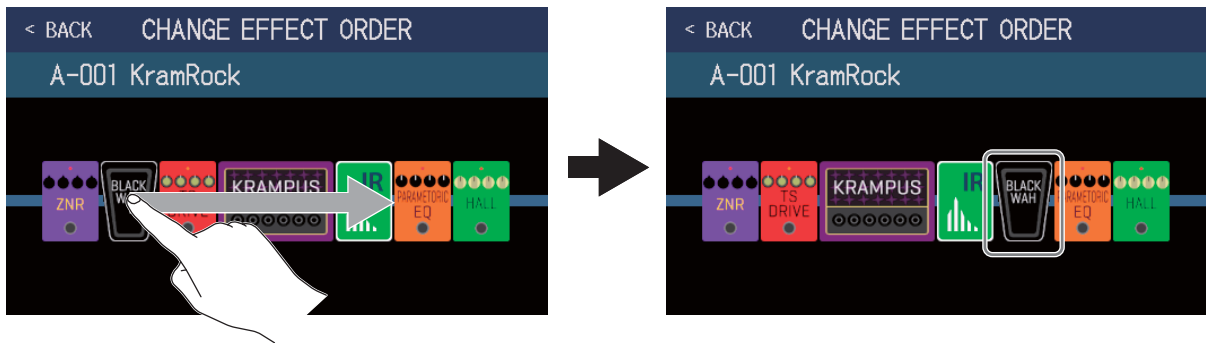

Adding effects



Effects can be added to patch memories as desired.

NOTE

Up to 9 effects can be combined freely using the **G6**. (→ [“Number of effects in patch memories” on page 43](#))

1. Select the patch memory in which you want to add an effect.

2. Touch  on the Menu Screen.

3. Drag the  to the position where you want to add an effect. Then, touch .

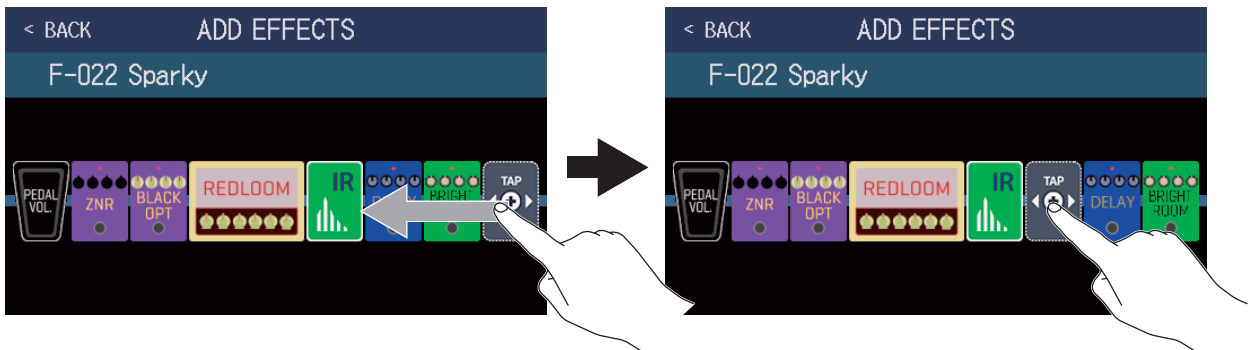

NOTE

If the maximum number of effects are in use,  will not be shown.

4. Touch the category of the effect that you want to add.

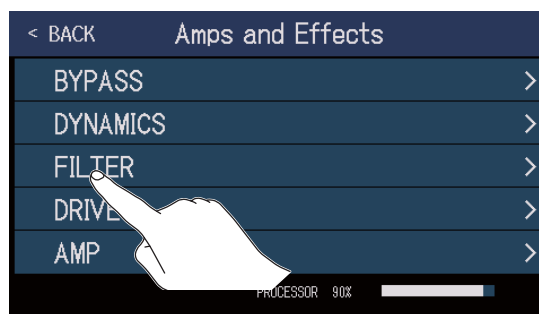

5. Touch an amp or effect to select it. Then, touch OK.

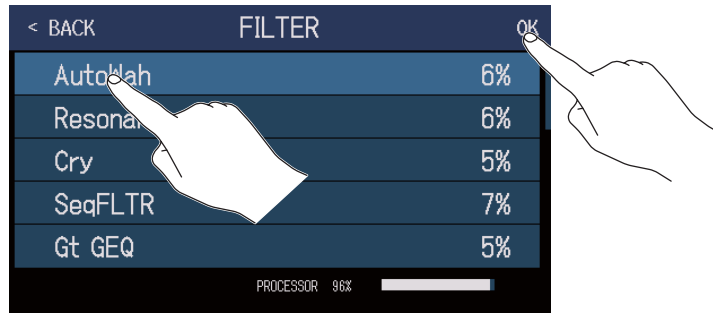

The selected effect will be added.

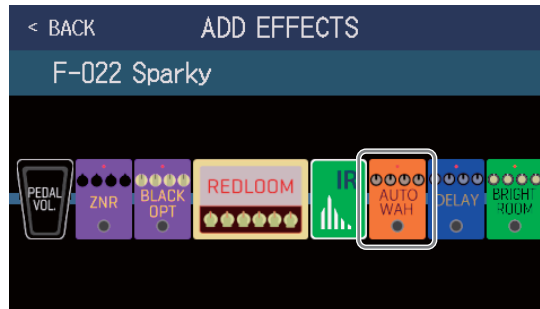



will appear again, so more effects can be added as necessary by repeating steps 3–5.

NOTE

If the EXTERNAL PEDAL setting is OFF (→ [page 72](#)), PEDAL category effects cannot be added to a patch memory that is already using a PEDAL category effect.

Deleting effects

Unneeded effects can be removed from patch memories.

1. Select the patch memory that has an effect you want to delete.
2. Touch  on the Menu Screen.
3. Touch  on an effect to delete it.
The selected effect will be deleted.

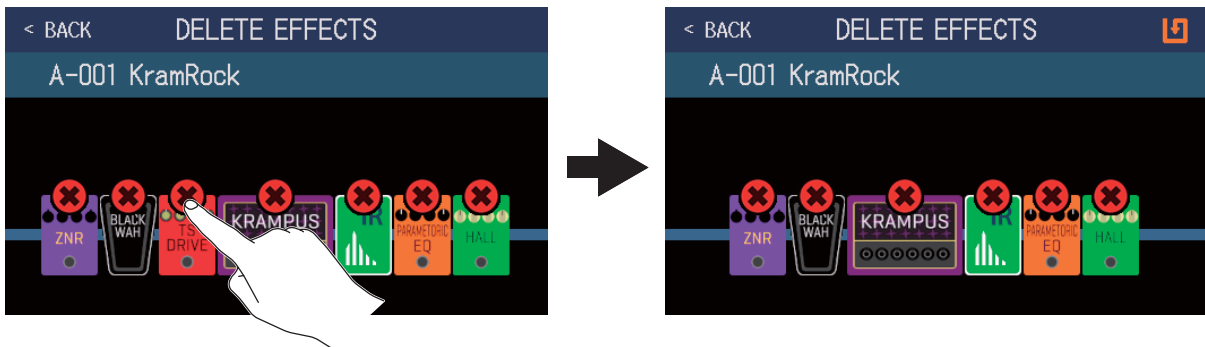

Making all settings on one screen

Patch memory editing operations can be conducted on a single screen.

1. Select the patch memory that you want to edit.
2. Touch  on the Menu Screen.
3. Edit the patch memory.

■ Turning amps and effects on/off

Touch the indicator above an amp or effect to turn it on/off.

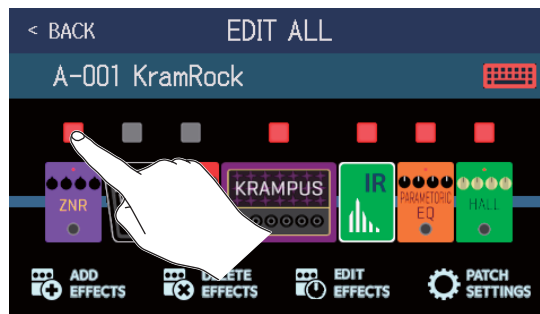

The indicator appears lit red when on and unlit when off.

■ Changing amps and effects

Touch the amp or effect that you want to change.

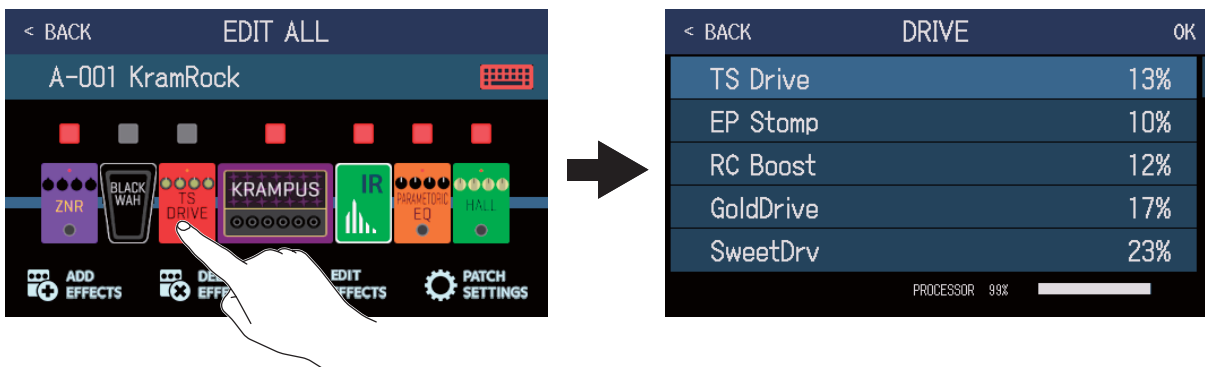

The touched amp or effect will appear in a list. Follow the procedures in [“Replacing effects” on page 41](#) to change it.

■ Changing effect order

Drag an effect type icon to move it to the desired position.

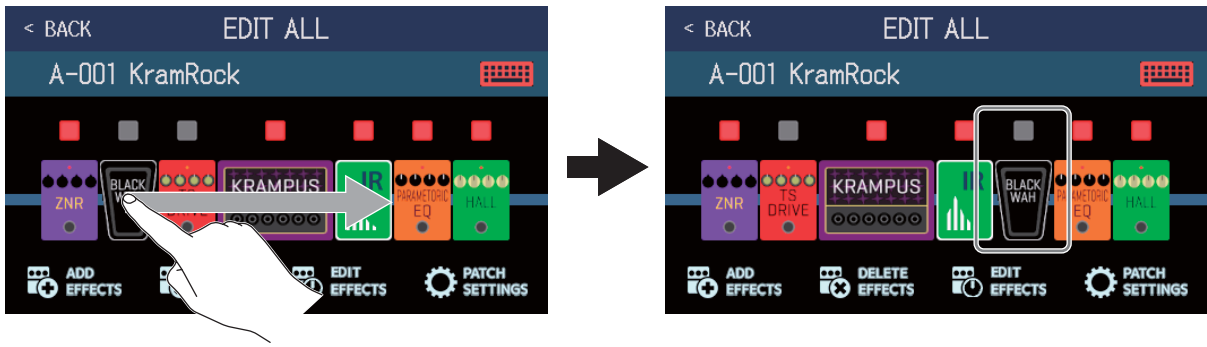

■ Adding effects

Touch ADD EFFECTS.

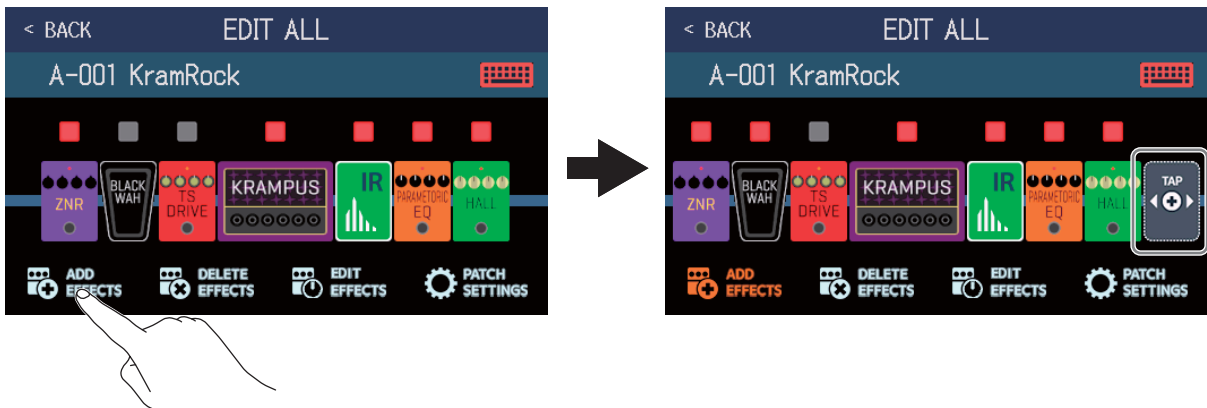

 will appear. Follow the procedures in [“Adding effects” on page 47](#) to add an effect.

■ Deleting effects

Touch DELETE EFFECTS.

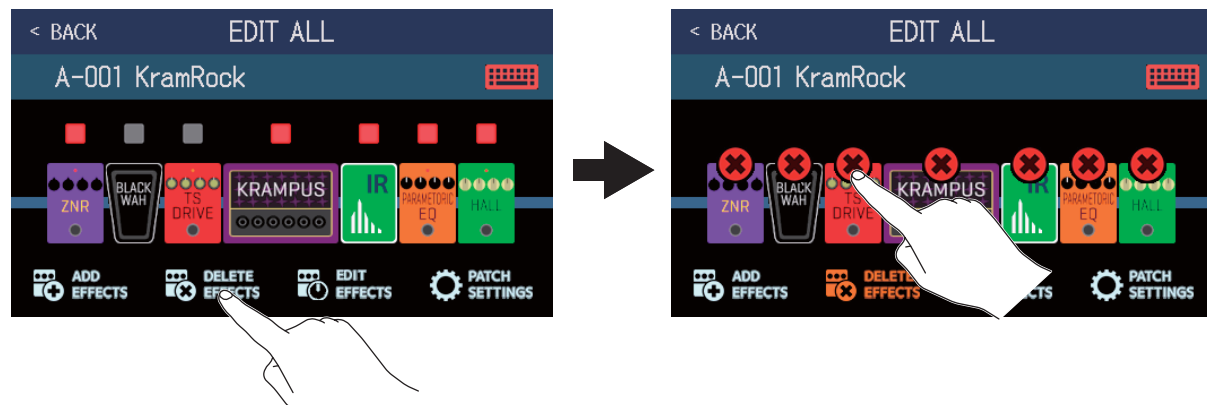

Touch  on the effect you want to delete to remove it from the patch memory.

■ Adjusting effects

Touch EDIT EFFECTS.

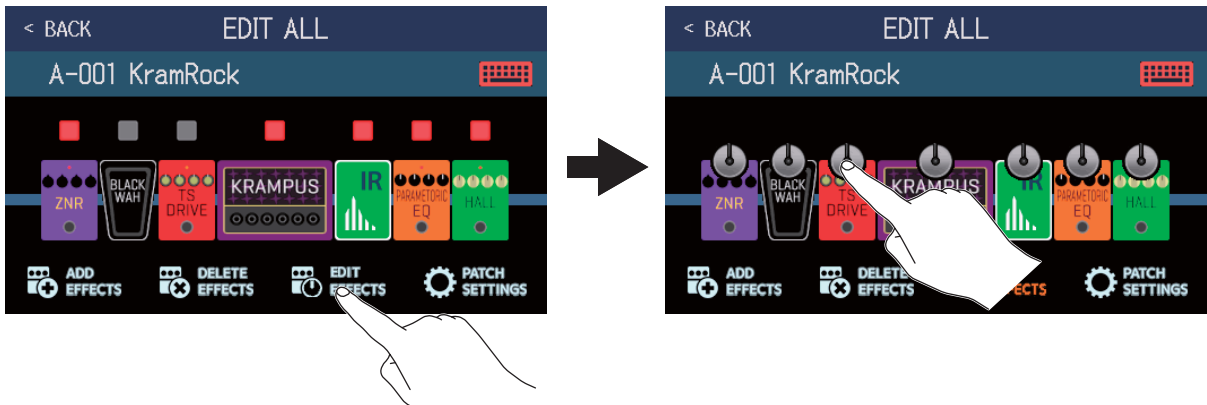

Touch  on the effect you want to edit to open the EDIT EFFECTS screen. Follow the instructions in [“Adjusting effects” on page 44](#) to adjust the effect.

■ Changing patch memory names

Touch .

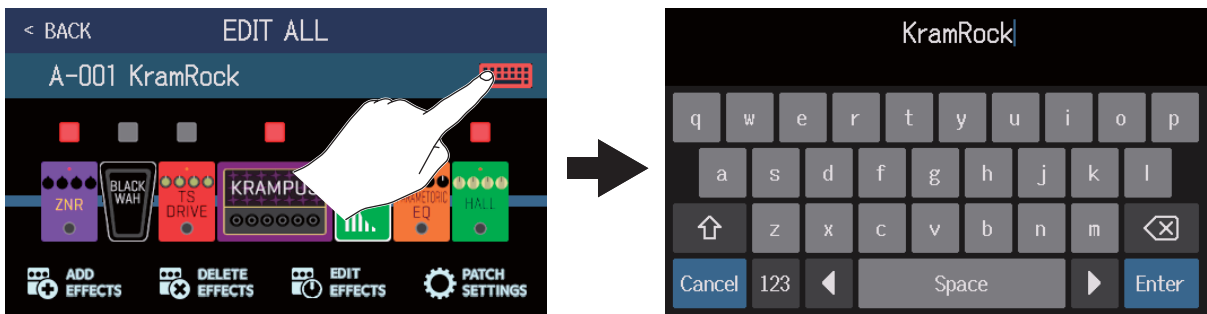

Touch the keyboard and input the patch memory name.
(→ [“Changing patch memory names” on page 54](#))

■ Setting the patch memory level

Touch PATCH SETTINGS.

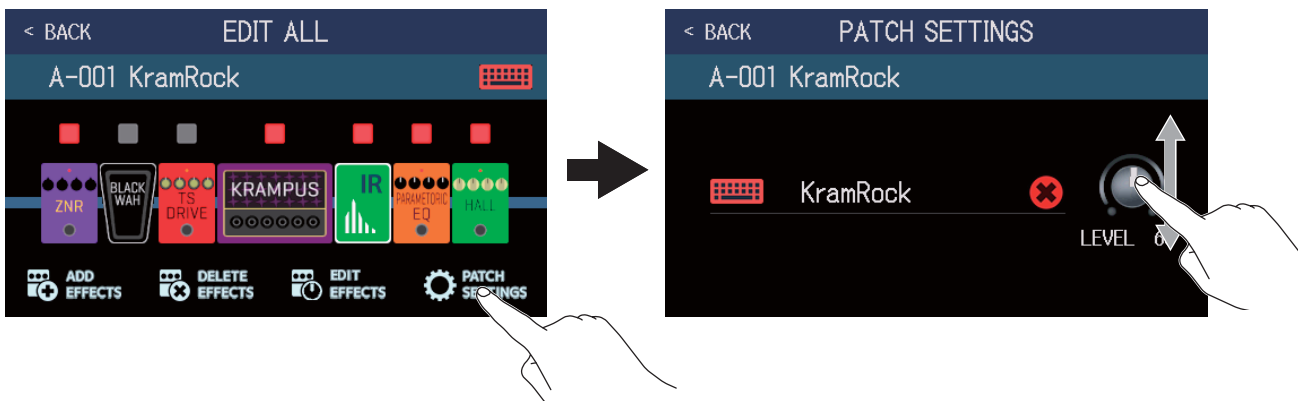

Drag the LEVEL knob to adjust the patch memory level. (→ [“Setting the patch memory level” on page 53](#))

Setting the patch memory level

The level can be set separately for each patch memory.

1. Select the patch memory for which you want to set the level.

2. Touch  on the Menu Screen.

3. Turn  or drag the LEVEL knob to set the level.

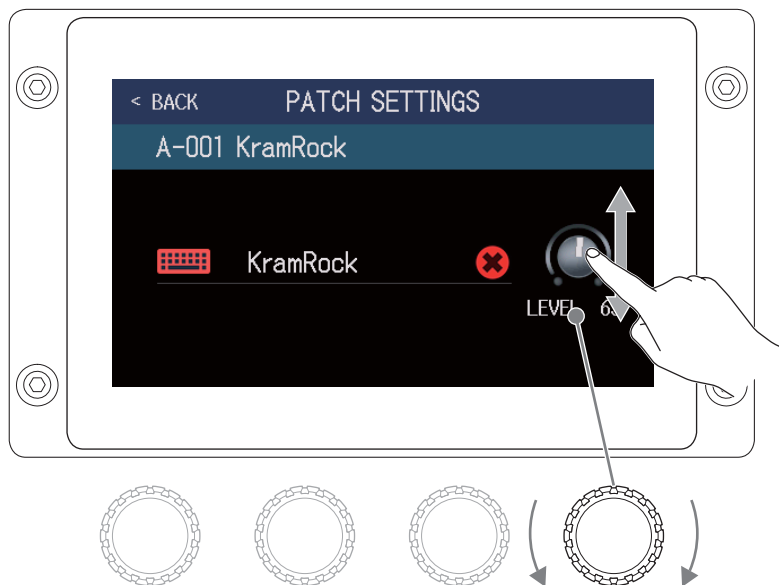

HINT

- The level can be set from 0 to 120.
-

Changing patch memory names

The names of patch memories can be changed.

1. Select the patch memory for which you want to change the name.

2. Touch  on the Menu Screen.

3. Touch  to open a keyboard.

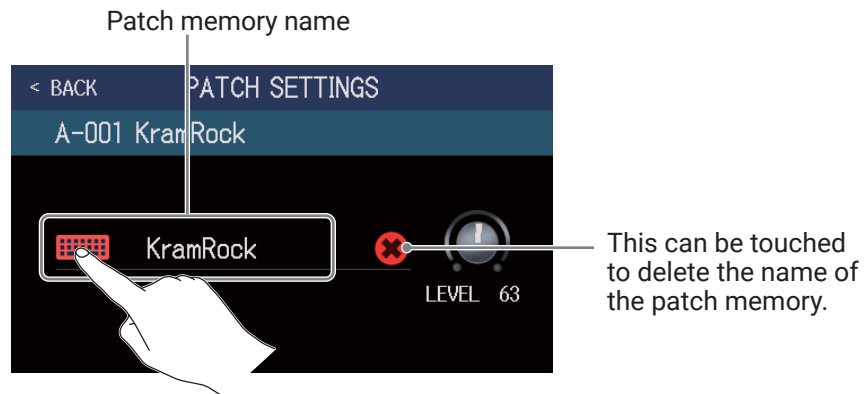

4. Touch the keyboard and input the patch memory name.

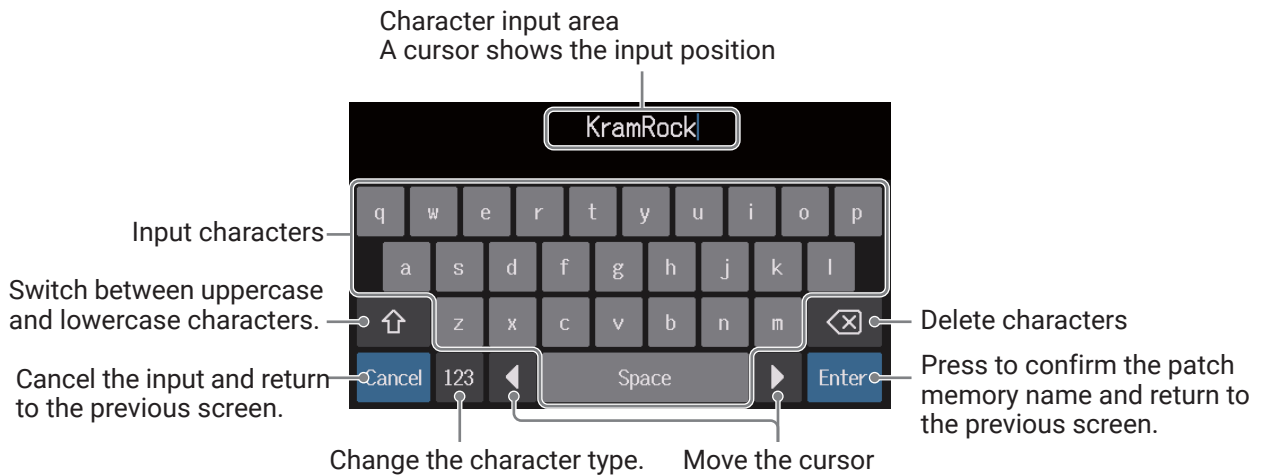

NOTE

The characters and symbols that can be used are as follows.

! # \$ % & ' () + , - . : ; = @ [\] ^ _ ` { } ~ (space) A-Z, a-z, 0-9

Adjusting the master tempo

The tempo used by rhythms, the looper, delay effects and some modulation effects can be adjusted.

1. Touch  SET TEMPO on the Menu Screen.

2. Adjust the tempo.

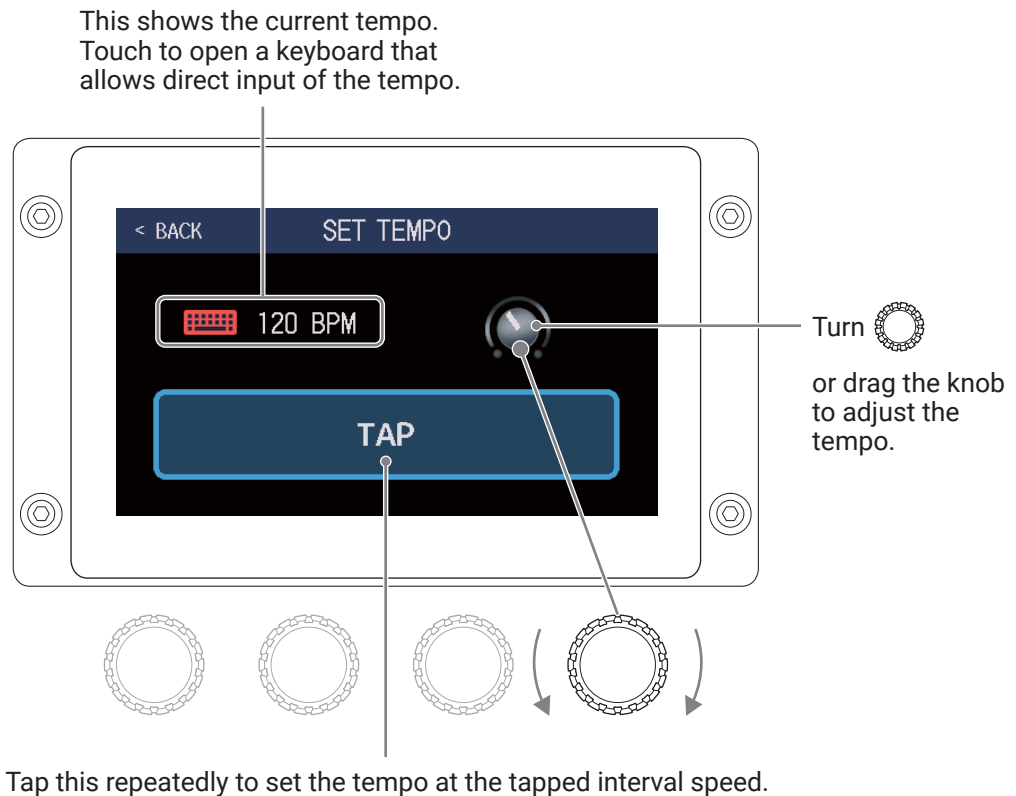

HINT

- The tempo can be set from 40 to 250 ♩ per minute.
- The tempo can also be set by repeatedly pressing  at intervals. The tempo is shown on the touchscreen while the tempo is being set.

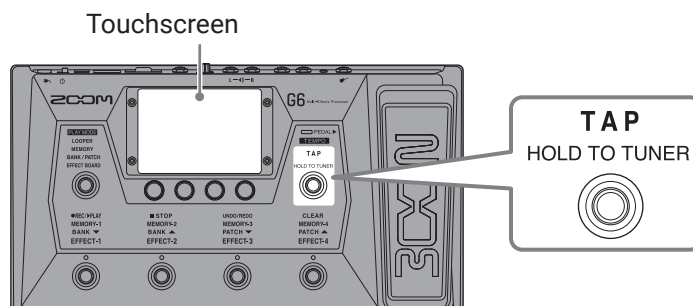

Managing patch memories

Saving patch memories

When the AUTOSAVE function is OFF (it is ON by default), effect and amp adjustments, level settings and other changes are not saved automatically. In this case, they can be saved manually.

Patch memories can also be saved to different locations.

HINT

See [“Setting the AUTOSAVE function” on page 94](#) for details about the AUTOSAVE function.

1. Select the patch memory that you want to save.
2. Touch  on the Menu Screen.
3. Save the patch memory.

Overwriting

Touch SAVE, and then touch SAVE again.

Patch memory to be saved

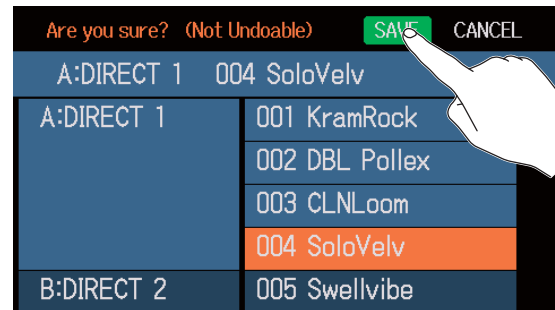
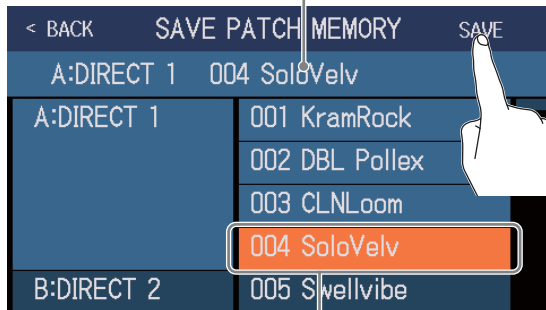

Save destination is highlighted

Saving to a different location

1. Swipe up or down to show the save destination.
Save destinations are shown by bank.

Patch memory to be saved

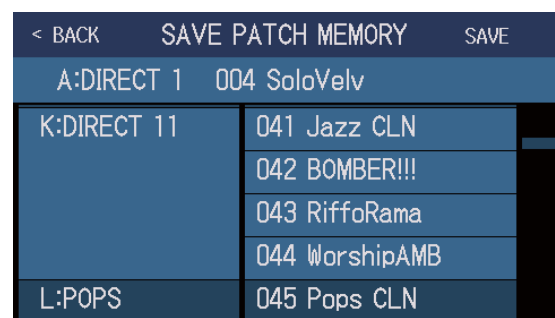
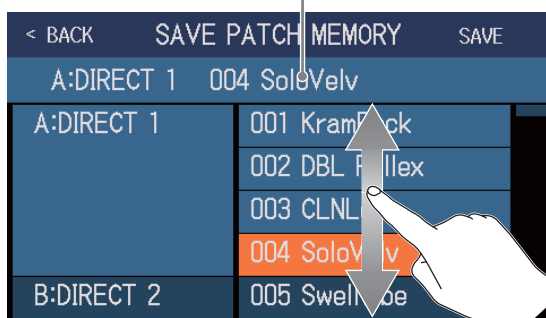

2. Touch the save destination.

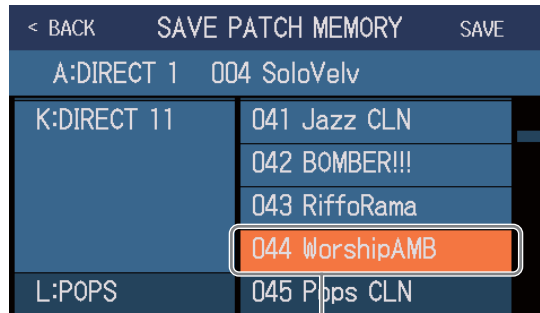

Save destination is highlighted

3. Touch SAVE.



4. Touch SAVE again to save in the selected location.

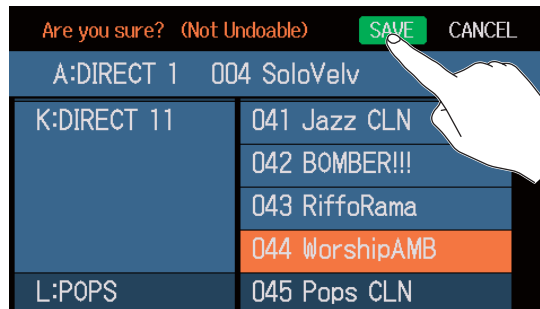

HINT

When the AUTOSAVE function is OFF, if the content of a patch memory has been changed,  will appear at the top right of the touchscreen, showing that it is different from the saved settings.

Touch  to open a screen where patch memories can be saved.

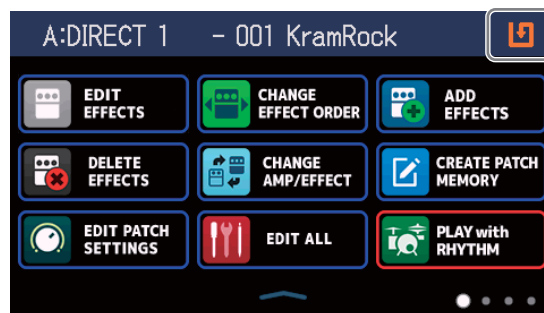

Changing the order of patch memories

The order of patch memories can be changed.

1. Touch  on the Menu Screen.

2. Drag the  of a patch memory up or down to change its order.

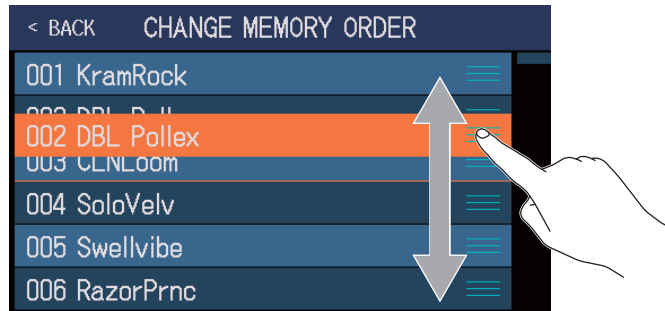

Deleting patch memories

Unneeded patch memories can be deleted.

1. Touch  on the Menu Screen.

2. Touch the patch memory that you want to delete.

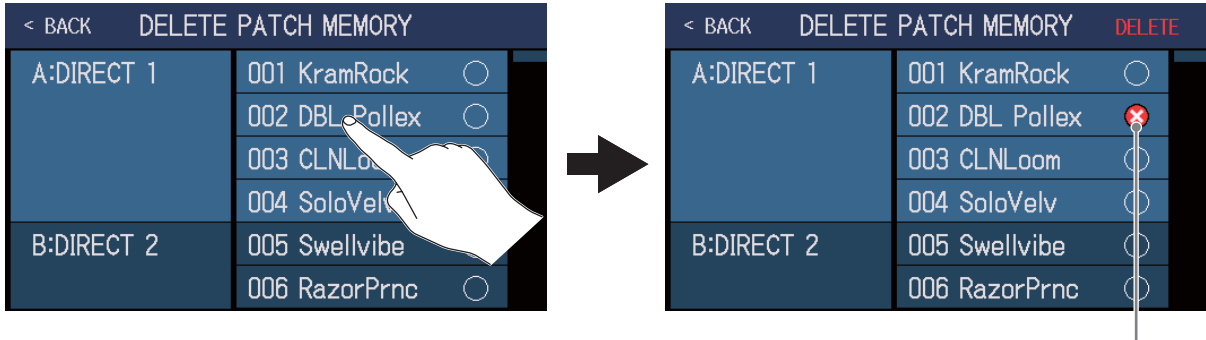

A deletion icon appears next to the touched patch memory.

HINT

- Patch memories are shown in banks.
- Multiple patch memories can be selected for deletion.
- To cancel deletion, touch it again to remove the DELETE icon.

3. Touch DELETE.

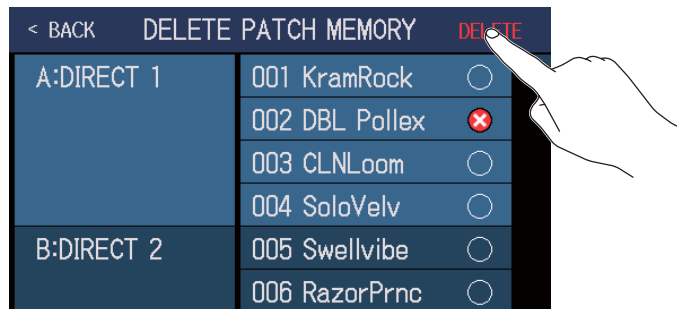

4. Touch DELETE.

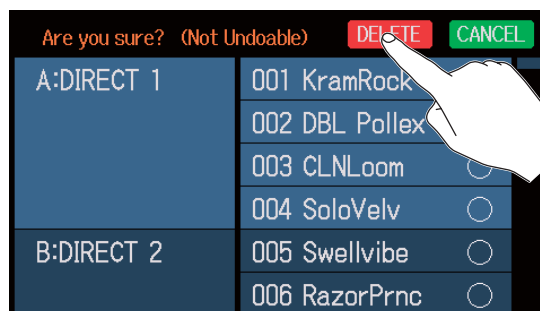

The deleted patch memory will become empty, and "Empty" will appear.

Creating patch memories

New patch memories can be created.

1. Touch  on the Menu Screen.

This opens a screen for patch memory creation.

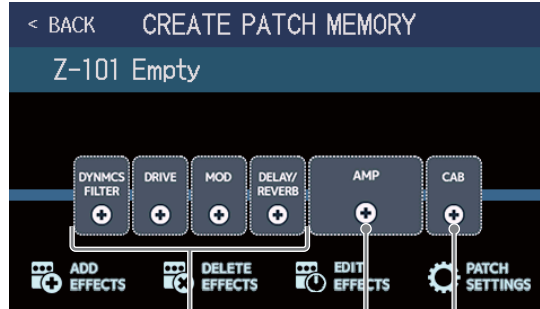

Select effects

Select an amp

Select a speaker cabinet

On the patch memory creation screen, 4 effect categories, an amp and a speaker cabinet are arranged in advance.

Select the effects, amp and speaker that you like for each to create a patch memory.

- DYNMCS/FILTER: Compressors and other dynamics effects, as well as equalizers and other filter effects
- DRIVE: Distortion, overdrive and similar effects
- MOD: Chorus, flanger and other modulation effects
- DELAY/REVERB: Delays, reverbs and other spatial effects

NOTE

Up to 240 patch memories can be saved. If there are no openings, the patch memory creation screen will not be shown. Delete an unneeded patch memory before creating a new one.

2. Touch the icon for the effect, amp or speaker cabinet that you want to select.

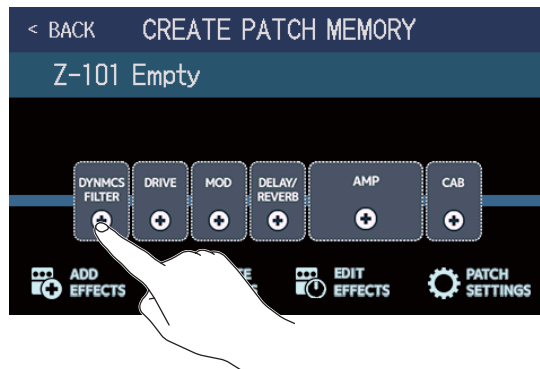

3. Select a category.

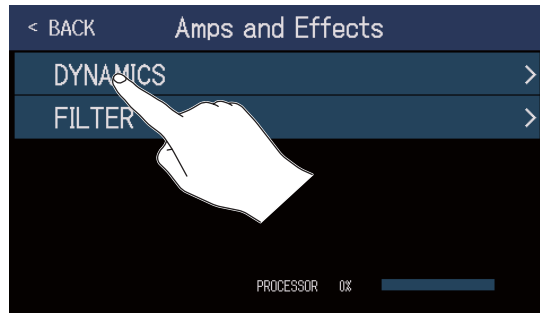

The category selection screen only appears when DYNAMICS/FILTER or DELAY/REVERB is selected. Proceed to step 4.

4. Touch an amp or effect to select it. Then, touch OK.

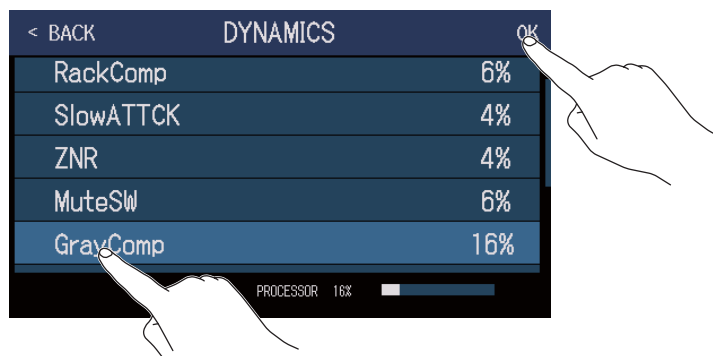

The selected effect or amp will be activated.

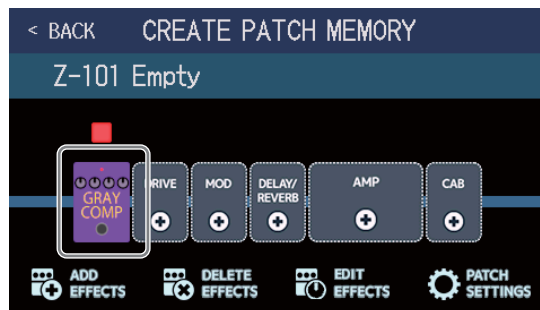

5. Repeat steps 2–4 to select amps and effects.

If the AUTOSAVE function (→ [page 94](#)) is ON, the patch memory will be saved automatically.

If the AUTOSAVE function is OFF, touch  to open the patch memory saving screen. Follow the procedures in [“Saving patch memories” on page 56](#) to save it.

6. Edit the patch memory as necessary.

Effects can be added, deleted and edited. The patch memory name can also be changed and the patch level adjusted, for example.

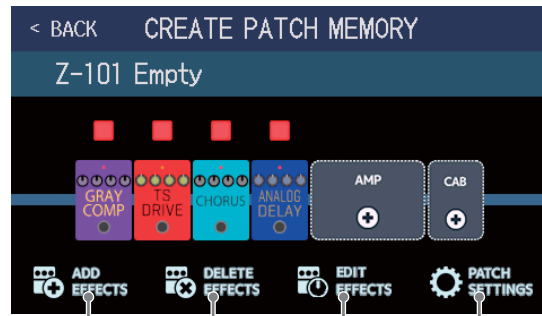

Use to add effects.
(→ [“Adding effects” on page 47](#))

Use to delete effects.
(→ [“Deleting effects” on page 49](#))

Use to adjust effects.
(→ [“Adjusting effects” on page 44](#))

Use to change patch memory names and levels.
(→ [“Changing patch memory names” on page 54](#), [“Setting the patch memory level” on page 53](#))

Managing banks

Changing the bank order

The order of banks can be changed.

1. Touch  on the Menu Screen.

2. Drag the  of a bank up or down to change its order.

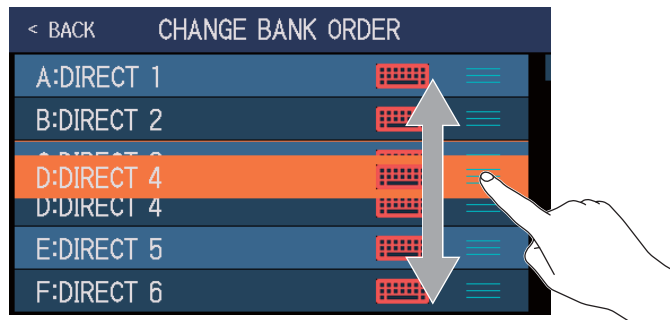

HINT

Touch  to open a keyboard that enables changing the bank name.

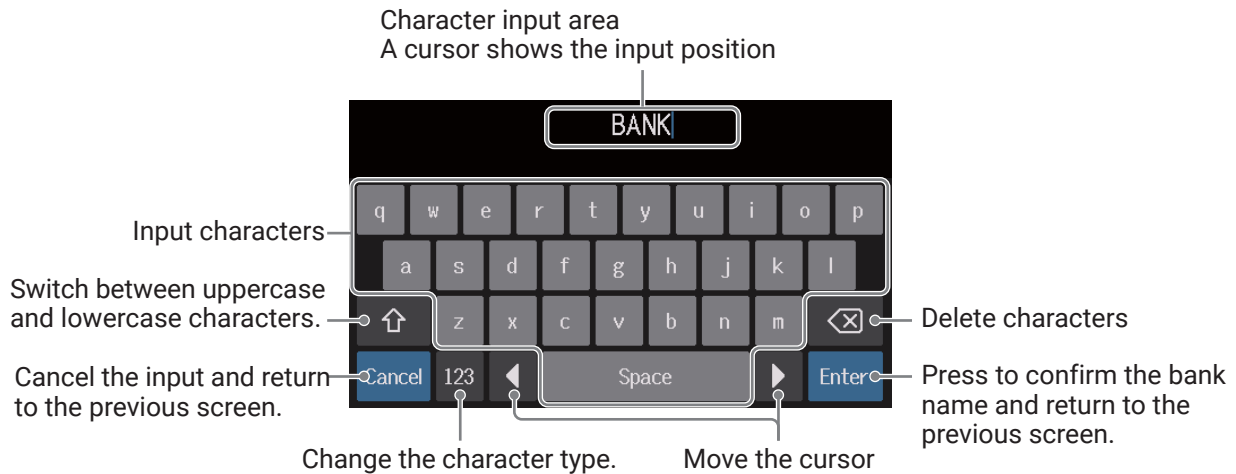

Deleting banks

Unneeded banks can be deleted.

1. Touch  on the Menu Screen.

2. Touch for the bank that you want to delete.

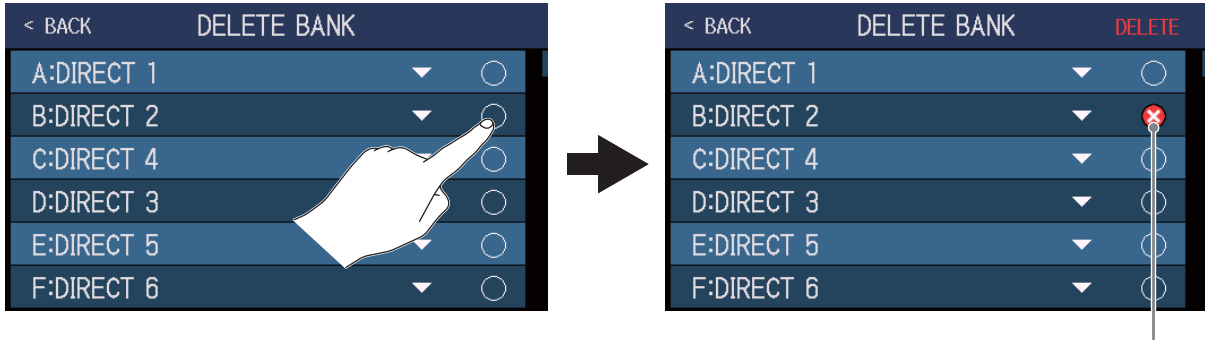

A deletion icon appears next to the touched bank.

HINT

- Multiple banks can be selected for deletion.
- Touch the DELETE icon to deselect the item.
- Touch ▼ to check the patch memories in a bank.

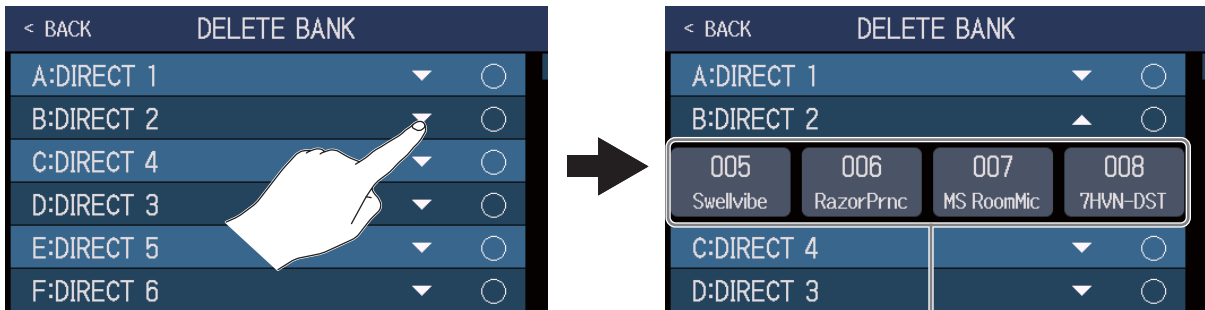

Patch memories in the bank

3. Touch DELETE.

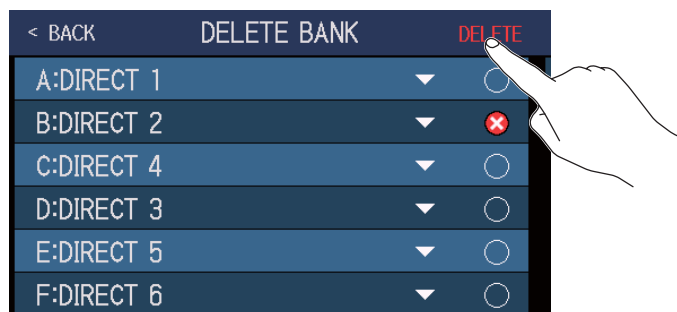

4. Touch DELETE.

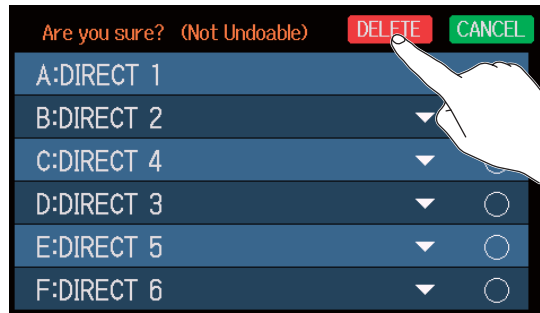

When a bank is deleted, the banks after it will move up in order.

NOTE

Deleting a bank also deletes the patch memories in it. Be sure this is okay before deleting.

Creating banks

New banks can be created.

1. Touch  on the Menu Screen.

NOTE

If "All banks are full. Please delete a bank and try again." appears on the touchscreen, there are no empty banks. Delete an unneeded bank. (→ ["Deleting banks" on page 64](#))

2. Touch .

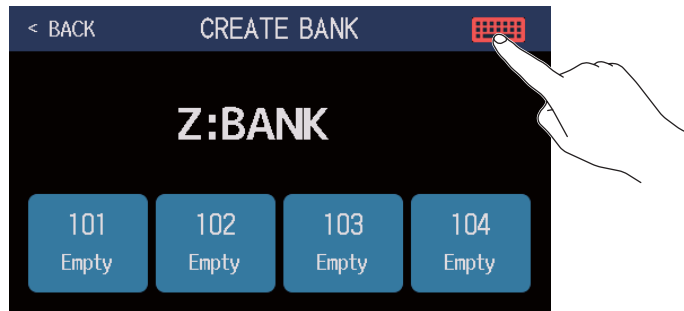

3. Input the bank name.

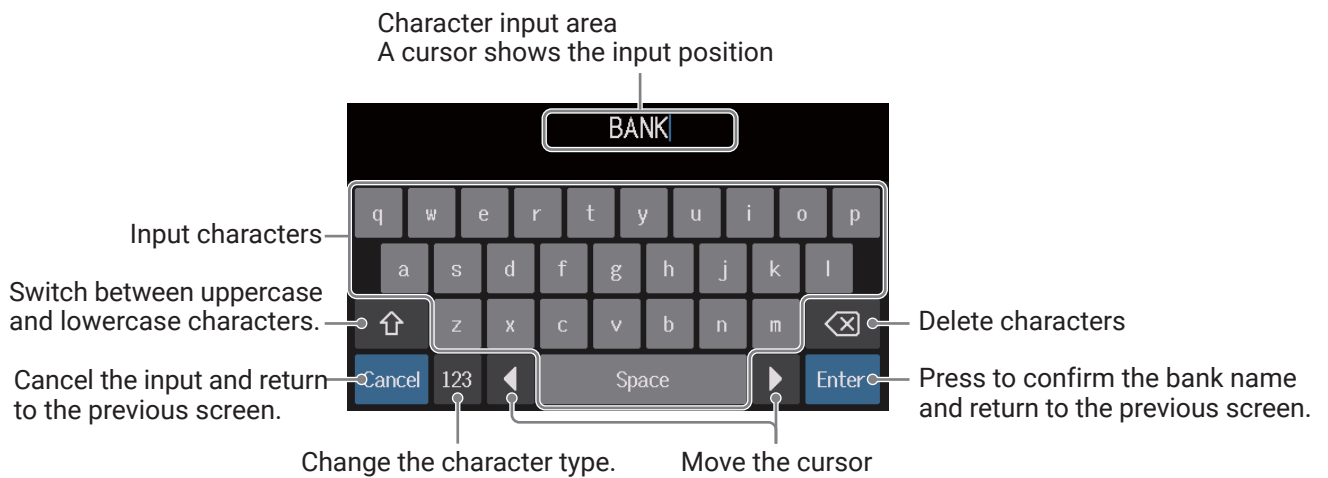

NOTE

The characters and symbols that can be used are as follows.
! # \$ % & ' () + , - . ; = @ [] ^ _ ` { } ~ (space) A-Z, a-z, 0-9

4. Touch a location where you want to assign a patch memory.

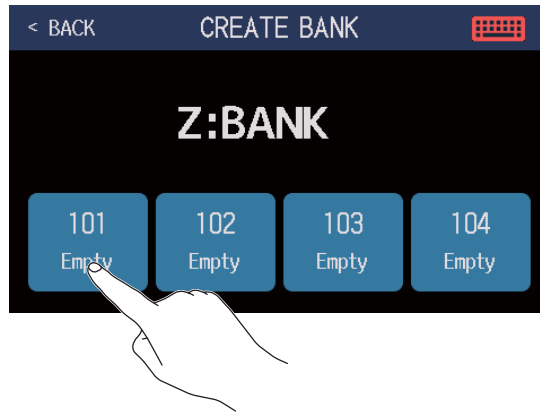

5. Touch the patch memory you want to assign, and touch OK.

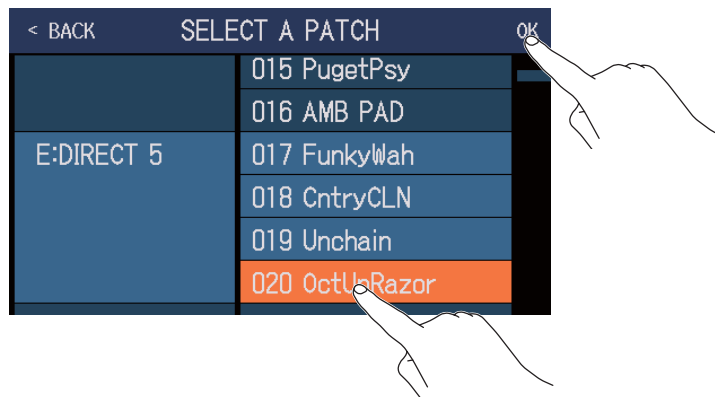

The selected patch memory will be assigned.

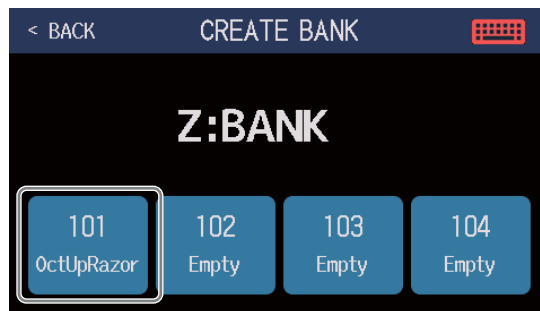

6. Repeat steps 4–5 to select other patch memories.

Using expression pedals



If an effect in the PEDAL category (pedal effect) is selected in a patch memory, the application of the effect can be controlled by an expression pedal.

Using the built-in pedal

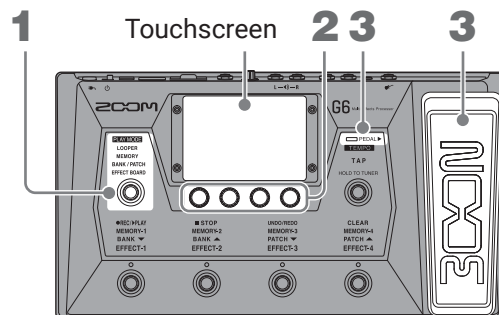
The built-in expression pedal can be used to change the application of the effect.



1. Select a patch memory that has a pedal effect you want to adjust.

Press  repeatedly to select **EFFECT BOARD**, or touch  on the Menu Screen to check the selected effect in the patch memory.

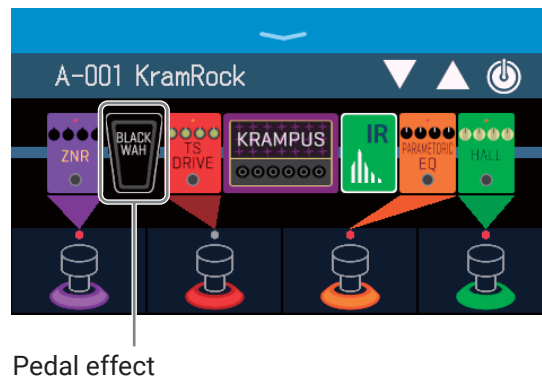



- To change the pedal effect, see [“Replacing effects” on page 41](#).
- To add a pedal effect, see [“Adding effects” on page 47](#).

NOTE

When an external pedal is connected, two effects from the PEDAL category can be used. (→ [“Using an external pedal” on page 72](#))

2. Adjust the pedal effect shown in the Effects Section.

Touch . Then, touch  on the pedal effect to open the EDIT EFFECTS screen. (→ [“Adjusting effects” on page 44](#))

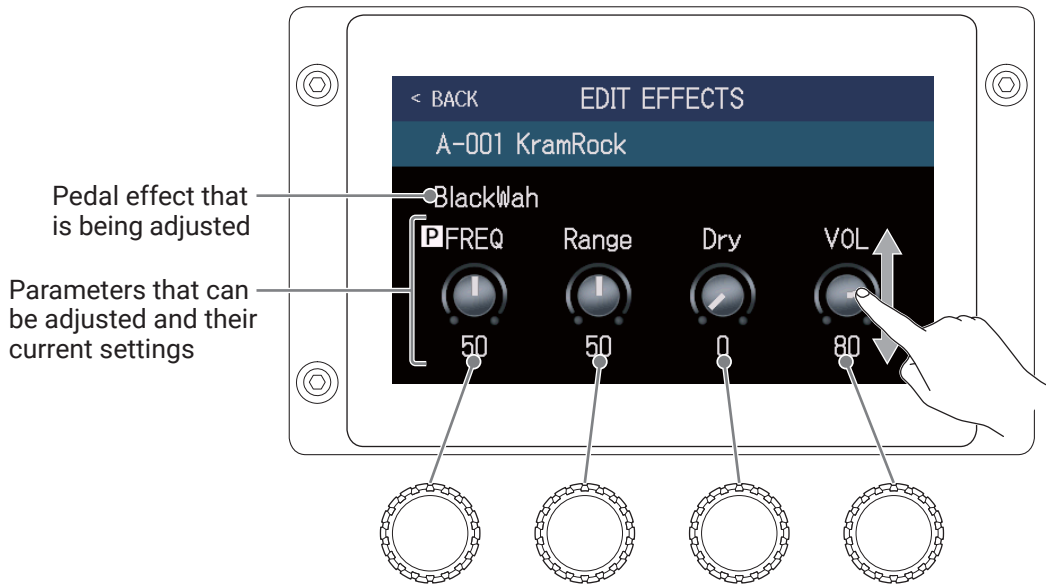

3. Use the expression pedal.

This changes the application of the effect.

Pressing the front of the pedal turns the pedal effect on/off. (When on, the pedal indicator lights.)

NOTE

The on/off status of the pedal effect changed by pressing the front of the pedal is not saved. (The on/off status changed by pressing the footswitch is saved. (→ [“Turning effects on and off while playing” on page 21](#)))

Adjusting the pedal

Calibrate the built-in expression pedal to adjust its sensitivity.

1. Touch  SET PEDAL on the Menu Screen.

2. Touch START next to PEDAL CALIBRATION.

This starts pedal calibration.



3. When the pedal is in its unpressed state (the front of the pedal is at its highest point), touch OK.

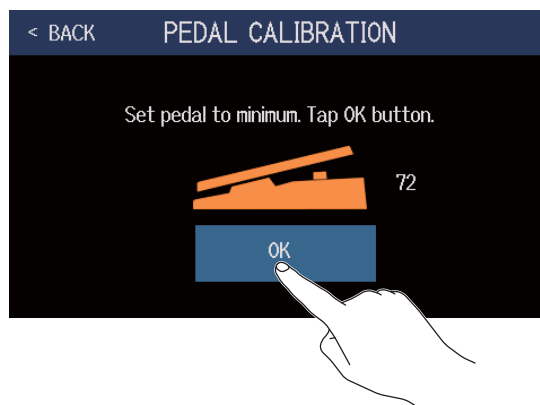

4. When the pedal is in its most pressed state, touch OK.

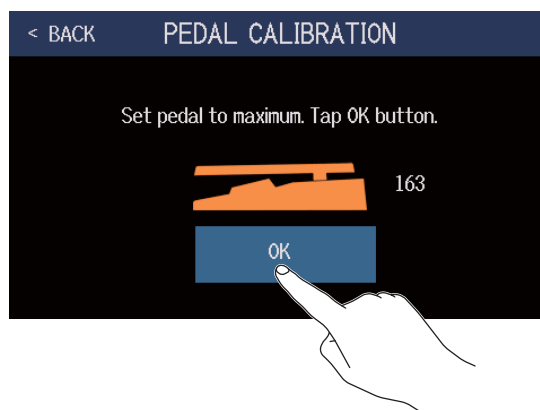

5. Touch OK to complete calibration.

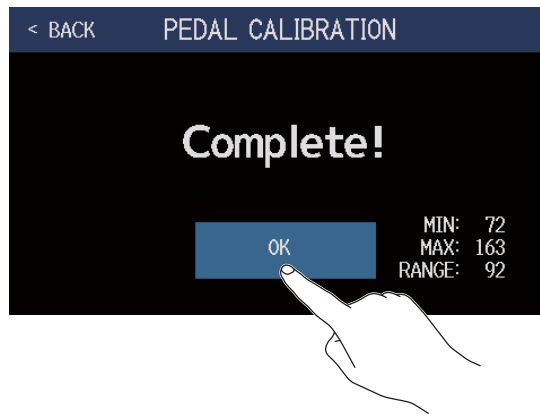

NOTE

- Adjust the pedal sensitivity in the following cases.
 - Stepping on the pedal has little effect.
 - The volume and tone changes greatly even when the pedal is only pressed lightly.
- If the following message appears on the touchscreen, touch OK and start calibration again.



Using an external pedal

When an external pedal is connected, two effects from the PEDAL category can be used. You can set a pedal effect to be assigned to the connected pedal.

1. Touch  on the Menu Screen.
2. Touch the EXTERNAL PEDAL switch to turn it ON.
Touching this toggles it ON/OFF.

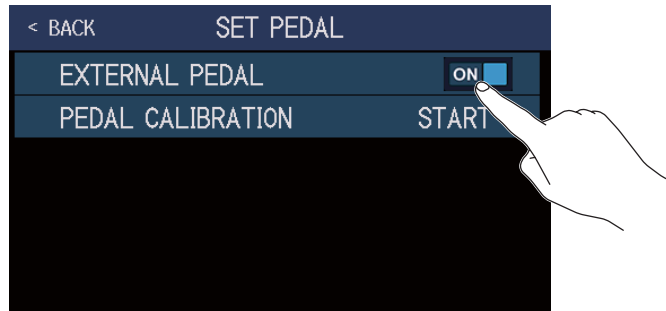

Setting	Explanation
OFF	External pedal use is disabled.
ON	External pedal use is enabled.

3. Select the patch memory for which you want to set an external pedal.

4. Touch  on the Menu Screen.

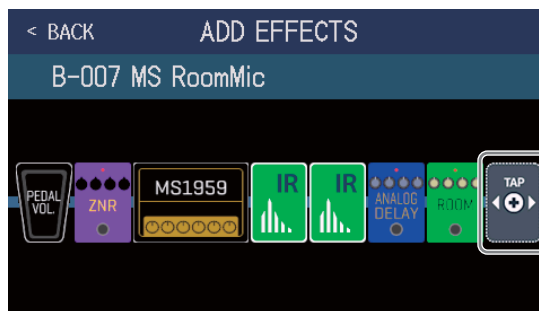

After  appears, follow the instructions in [“Adding effects” on page 47](#) to add a pedal effect (effect in the PEDAL category).

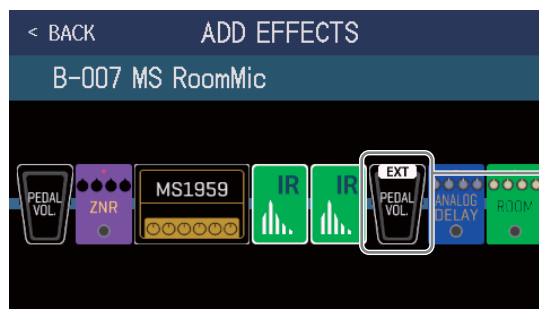

EXT will appear on the pedal effect used with the external pedal.

5. Adjust the added pedal effect.

Follow the procedures in [“Adjusting effects” on page 44](#) to adjust the effect.

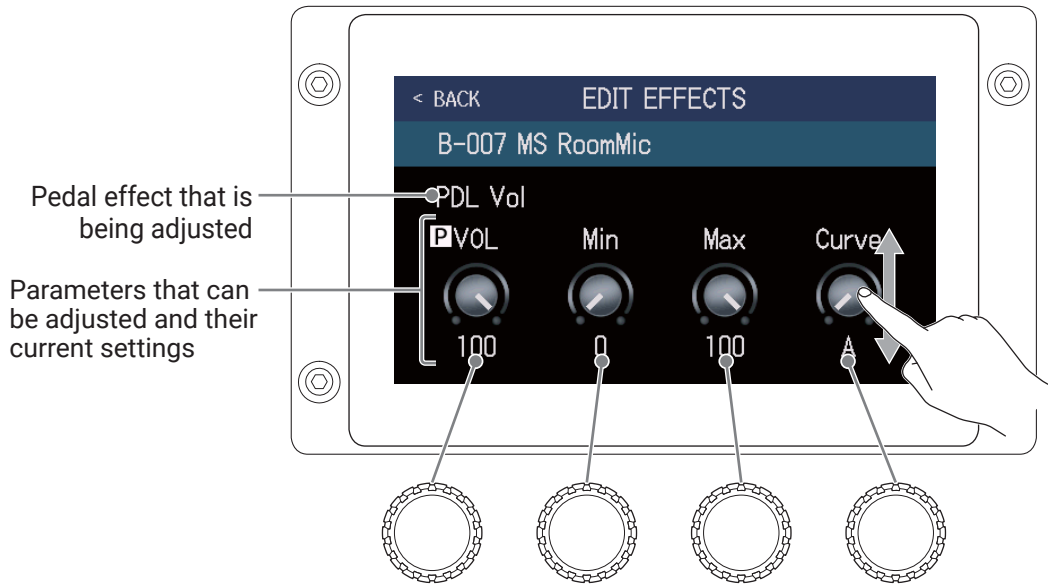

NOTE

When an external pedal effect has been added, if the EXTERNAL PEDAL setting is changed to OFF,  will appear on that effect and it will be disabled.

Using the tuner

Activating the tuner

Activate the tuner to use the **G6** to tune a guitar.

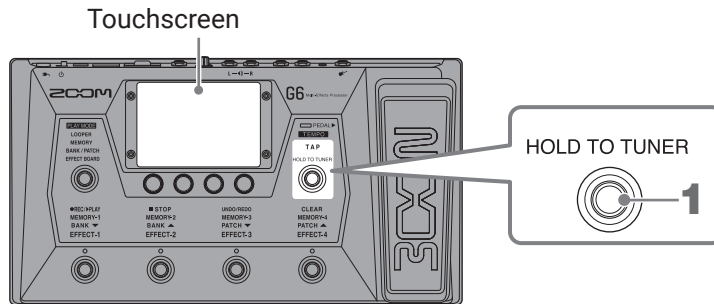

1. Press and hold , or touch  on the Menu Screen.

This activates the tuner and opens the USE TUNER screen.

2. Play the open string that you want to tune and adjust its pitch.

Touch to mute the sound.



This shows the tuner type and standard pitch. Touch this to change tuner settings. (→ ["Changing tuner settings" on page 75](#))

- The nearest note name and pitch detuning will be shown.
- When the pitch is accurate, the left and right indicators will become green.
- Different tuner types can be shown by swiping right and left.

■ Closing the tuner

Press  when the tuner is in use to close it and reopen the previous screen.

Changing tuner settings

The standard pitch used by the tuner and the tuner type can be changed. Flat tuning is also possible.

1. Touch  on the Menu Screen.

2. Changing tuner settings

■ Changing the standard pitch of the tuner

Drag the CALIBRATION knob up and down or turn  to change the standard pitch.

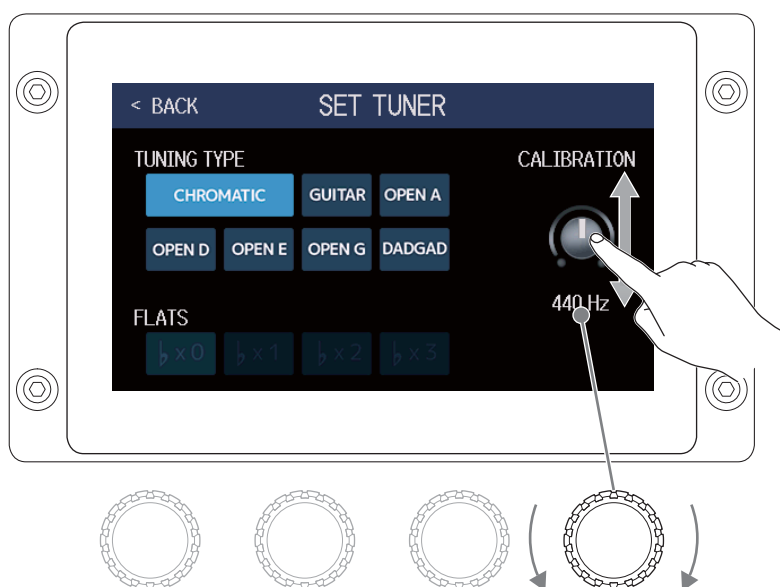

HINT

- The setting range is 435–445 Hz for middle A.

■ Setting the tuner type

Touch the desired tuner type.

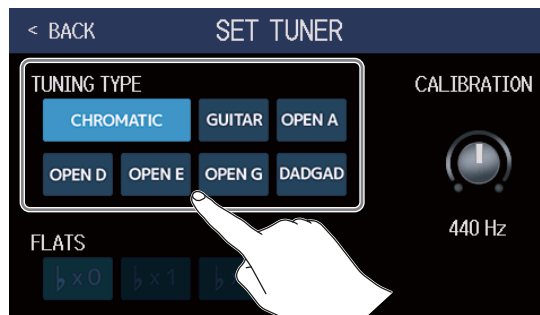

Setting	Explanation
CHROMATIC	The pitch detuning is shown according to the nearest note (in semi-tones).
Other tuner types	The nearest string number is shown according to the selected type, and the amount of detuning from its pitch is shown. The following tuner types can be selected.

Display	Explanation	String number/note						
		7	6	5	4	3	2	1
GUITAR	Standard guitar tuning with a 7th string	B	E	A	D	G	B	E
OPEN A	Open A tuning (open strings play A chord)	-	E	A	E	A	C#	E
OPEN D	Open D tuning (open strings play D chord)	-	D	A	D	F#	A	D
OPEN E	Open E tuning (open strings play E chord)	-	E	B	E	G#	B	E
OPEN G	Open G tuning (open strings play G chord)	-	D	G	D	G	B	D
DADGAD	Alternate tuning often used for tapping and other techniques	-	D	A	D	G	A	D

■ Using flat tunings

All strings can be tuned flat from an ordinary tuning by 1 ($\flat \times 1$), 2 ($\flat \times 2$) or 3 ($\flat \times 3$) semitones. Touch the desired flat tuning.

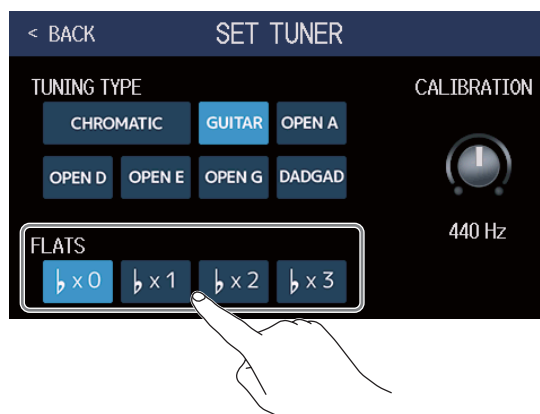

NOTE

Flat tuning cannot be used when the tuner type is CHROMATIC.

Using rhythms

You can play along with built-in rhythms.

Activating rhythms

When this function is activated, rhythms can be set and played.

1. Touch  on the Menu Screen.

This activates the rhythm function and opens the PLAY with RHYTHM screen.



Rhythms can be played, stopped and set using the touchscreen and parameter knobs.

Setting rhythms

Various rhythm settings can be made.

Selecting rhythm patterns

The rhythm pattern played can be selected.

1. Touch the rhythm pattern name on the PLAY with RHYTHM screen (→ [page 77](#)).

Rhythm pattern name

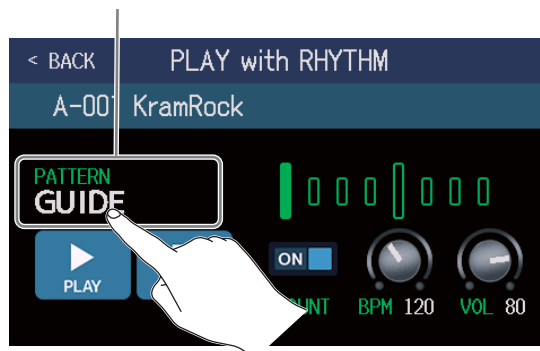

2. Touch the desired rhythm pattern. Then, touch BACK.

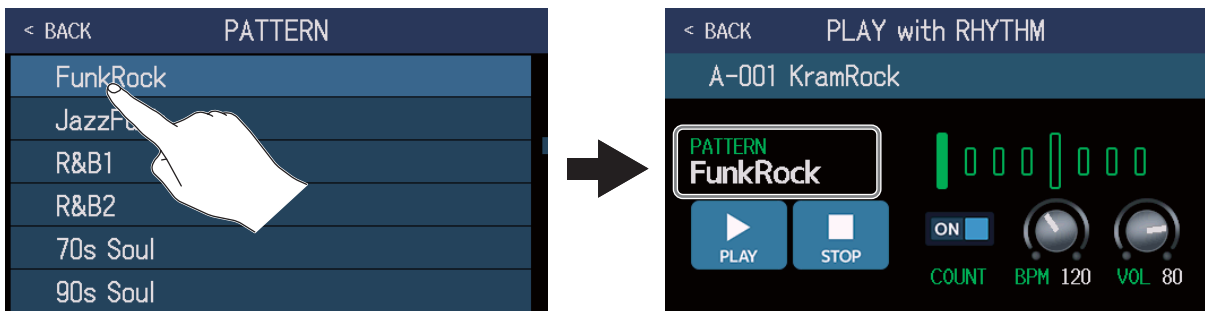

The selected rhythm pattern will be activated.

HINT

- See "[Rhythm patterns](#)" on [page 83](#) for information about the rhythm pattern types.
-  can also be turned to select rhythm patterns.

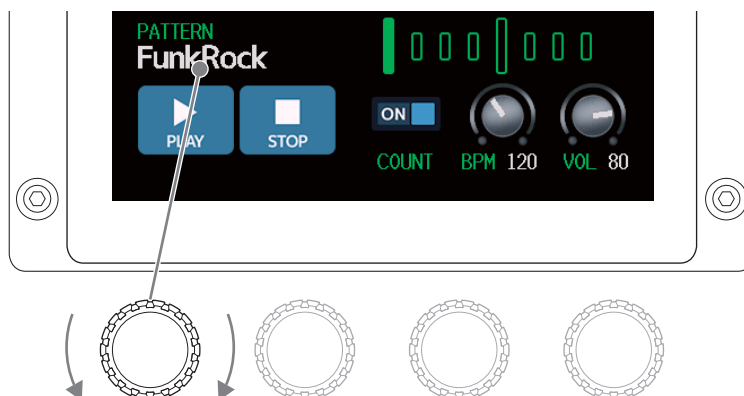

Setting the precount

This sets whether or not a count sound is played before looper recording starts.

1. Touch COUNT on the PLAY with RHYTHM screen (→ [page 77](#)).

Touching this toggles it ON/OFF.

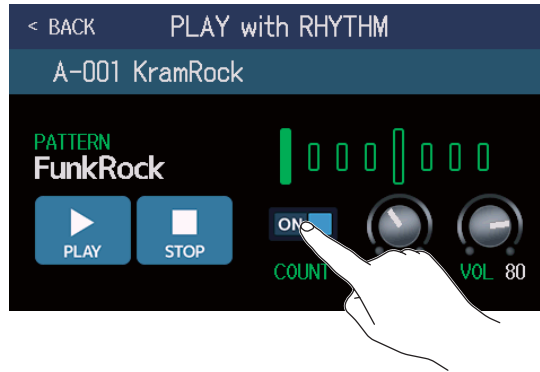

Setting	Explanation
OFF	A precount is not played.
ON	A precount is played.

Adjusting the tempo

The tempo of the rhythm can be adjusted.

1. Turn  on the PLAY with RHYTHM screen (→ [page 77](#)) or drag the BPM knob up and down.



HINT

- This can be set from 40 to 250.
- The tempo set here will be shared by the effects and the looper.
- The tempo can also be set by repeatedly pressing  at intervals. The tempo is shown on the touchscreen while the tempo is being set.

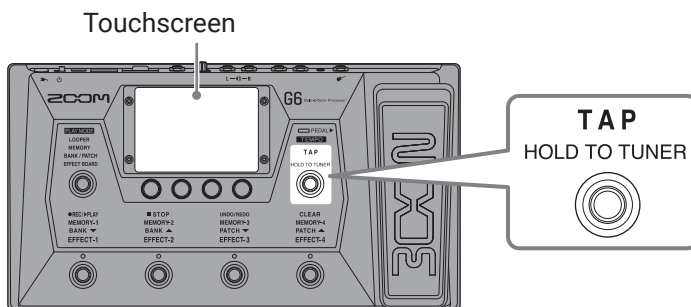

Adjusting the volume

The volume of the rhythm can be adjusted.

1. Turn  on the PLAY with RHYTHM screen (→ [page 77](#)) or drag the VOL knob up and down.



HINT

This can be set from 0 to 100.

Starting/stopping rhythm playback

Rhythm playback can be started and stopped.

1. Touch PLAY or STOP on the PLAY with RHYTHM screen (→ [page 77](#)).



HINT

The play mode can be selected and the Menu Screen can be opened during rhythm playback. This allows patch memories to be selected and the looper to be used, for example, while the rhythm continues to play. To stop the rhythm when doing other operations, touch  on the Menu Screen and then stop it.

Rhythm patterns

No.	Pattern Name	Time Sig.
1	GUIDE	4/4
2	8Beats1	4/4
3	8Beats2	4/4
4	8Beats3	4/4
5	16Beats1	4/4
6	16Beats2	4/4
7	16Beats3	4/4
8	Rock1	4/4
9	Rock2	4/4
10	Rock3	4/4
11	ROCKABLY	4/4
12	R'n'R	4/4
13	HardRock	4/4
14	HeavyMtl	4/4
15	MtlCore	4/4
16	Punk	4/4
17	FastPunk	4/4
18	Emo	4/4
19	TomTomBt	4/4
20	Funk1	4/4
21	Funk2	4/4
22	FunkRock	4/4
23	JazzFunk	4/4

No.	Pattern Name	Time Sig.
24	R&B1	4/4
25	R&B2	4/4
26	70's Soul	4/4
27	90's Soul	4/4
28	Motown	4/4
29	HipHop	4/4
30	Disco	4/4
31	Pop	4/4
32	PopRock	4/4
33	IndiePop	4/4
34	EuroPop	4/4
35	NewWave	4/4
36	OneDrop	4/4
37	Steppers	4/4
38	Rockers	4/4
39	Ska	4/4
40	2nd Line	4/4
41	Country	4/4
42	Shuffle1	4/4
43	Shuffle2	4/4
44	Blues1	4/4
45	Blues2	4/4
46	Jazz1	4/4

No.	Pattern Name	Time Sig.
47	Jazz2	4/4
48	Fusion	4/4
49	Swing1	4/4
50	Swing2	4/4
51	Bossa1	4/4
52	Bossa2	4/4
53	Samba1	4/4
54	Samba2	4/4
55	Breaks1	4/4
56	Breaks2	4/4
57	Breaks3	4/4
58	12/8 Grv	12/8
59	Waltz	3/4
60	JzWaltz1	3/4
61	JzWaltz2	3/4
62	CtWaltz1	3/4
63	CtWaltz2	3/4
64	5/4 Grv	5/4
65	Metro3	3/4
66	Metro4	4/4
67	Metro5	5/4
68	Metro	

Using the send and return

External effects can be used by connecting them to the send and return jacks.

The send/return positions can be set as desired and saved in each patch memory.

NOTE

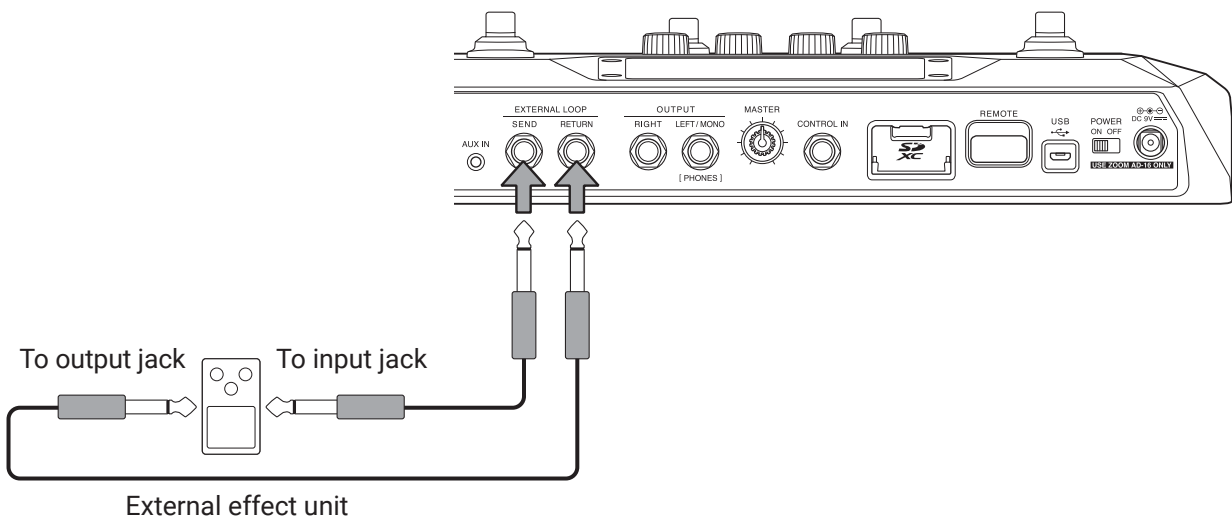

The send/return is counted as one of the maximum number of the effects in the patch memory. (→ [“Number of effects in patch memories” on page 43](#))

1. Connect the **G6** to an external effect.



2. Select the patch memory in which you want to set a send/return.

3. Touch  on the Menu Screen.

4. Drag  to the position where you want to set the send/return. Then, touch .

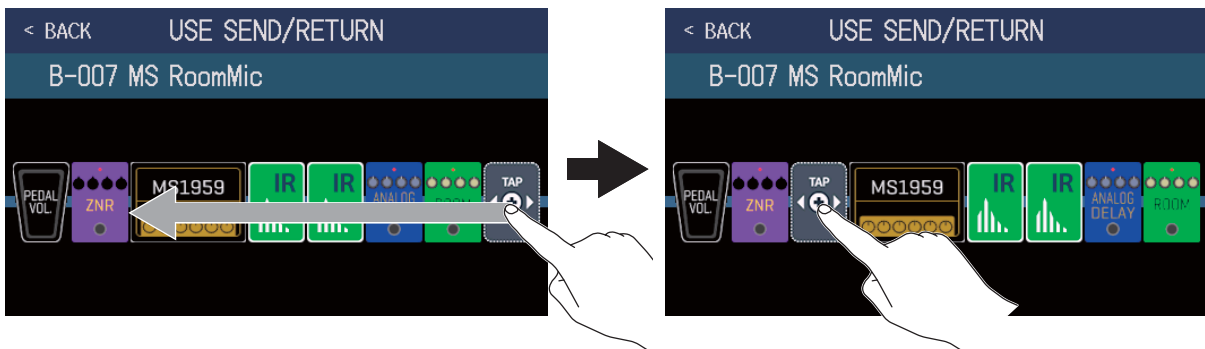

5. Touch the send/return setting. Then, touch OK.

Refer to the following applications when selecting the setting.

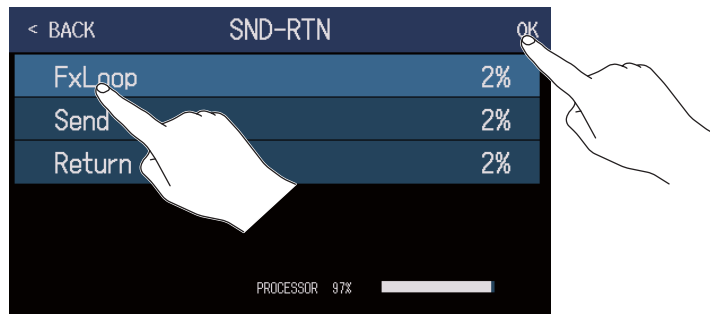

■ FxLoop

A signal will be sent to the external effect from the position set on the USE SEND/RETURN screen and a signal will be returned to the same position.

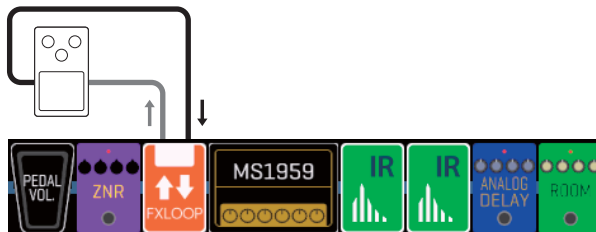

■ Send

A signal will be sent to the external effect from the position set on the USE SEND/RETURN screen.



■ Return

A signal will be returned from the external effect to the position set on the USE SEND/RETURN screen.



NOTE

- To delete a send/return, see [“Deleting effects” on page 49](#).
- To change a send/return, see [“Replacing effects” on page 41](#).

HINT

Sends/returns can also be added on the CHANGE AMP/EFFECTS screen (→ [“Adding effects” on page 47](#))

Using impulse responses (IR)

Impulse responses capture the acoustic characteristics of spaces and quantify them as data.

By capturing the acoustic characteristics of a guitar sound output from a speaker cabinet recorded by a microphone, the characteristics of various speaker cabinets can be quantified as data and used for effects.

Real guitar sounds can be re-created without output from speaker cabinets.

The **G6** ships new with data for 70 impulse responses.

You can also load and use your own impulse response data and impulse response data from third parties.

Using impulse responses (IR)

Impulse responses can be assigned to patch memories.

1. Select the patch memory in which to use the impulse response.

2. Touch  on the Menu Screen.

3. Touch .



Drag  to the position where you want to set the impulse response.

4. Touch the impulse response you want to use to select it. Then, touch OK.

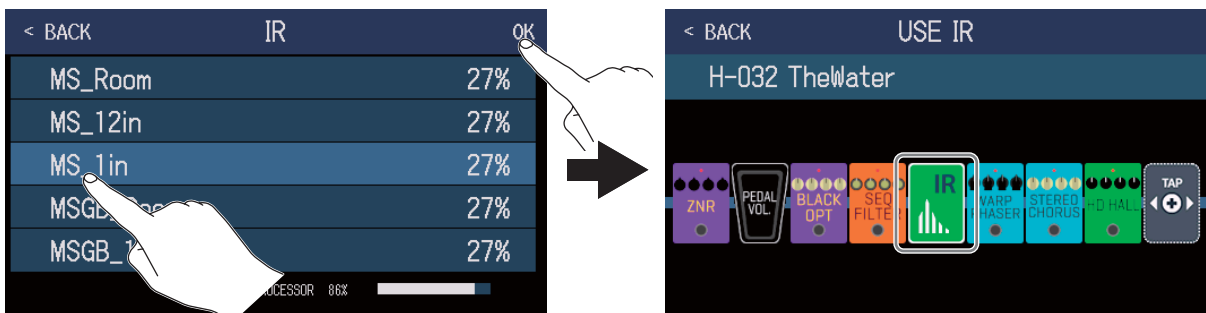

The selected impulse response will be added.

Loading impulse response (IR) data

You can load your own impulse response data and impulse response data from third parties.

NOTE

Impulse response data in the following format can be loaded.

- Format: WAV
- Sampling frequency: 44.1–192 kHz

1. Copy impulse response data to an SD card.

Copy impulse response data to the “G6_IR” folder on the SD card. (→ [“G6 folder and file structure” on page 104](#))

The “G6_IR” folder is created at the top level of an SD card when it is formatted by the **G6**. (→ [“Formatting SD cards” on page 101](#))

2. Insert the SD card (→ [“Inserting SD cards” on page 17](#)).

3. Touch on the Menu Screen.

4. Touch for the location where you want to save it.

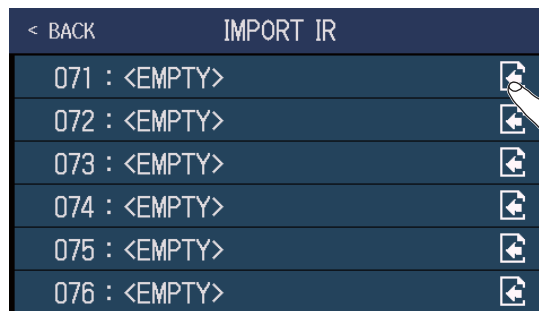

Impulse response data is already assigned to locations 001–070. You can assign impulse response data as you like to 071–200.

5. Touch the impulse response data that was assigned.

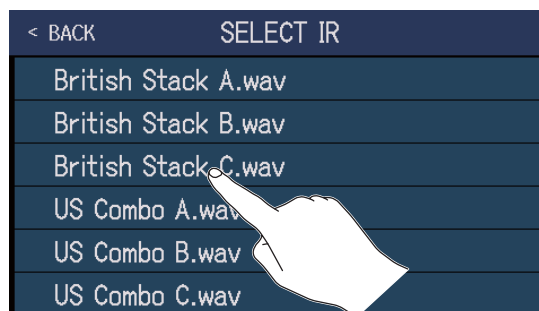

6. Touch .

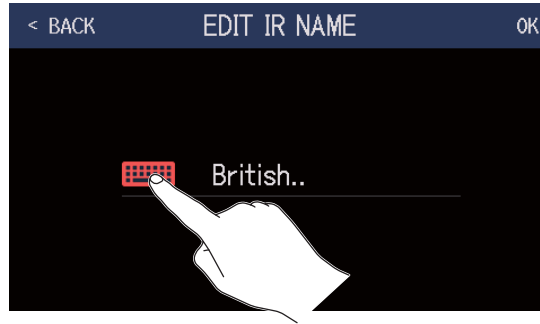

7. Input the impulse response name.

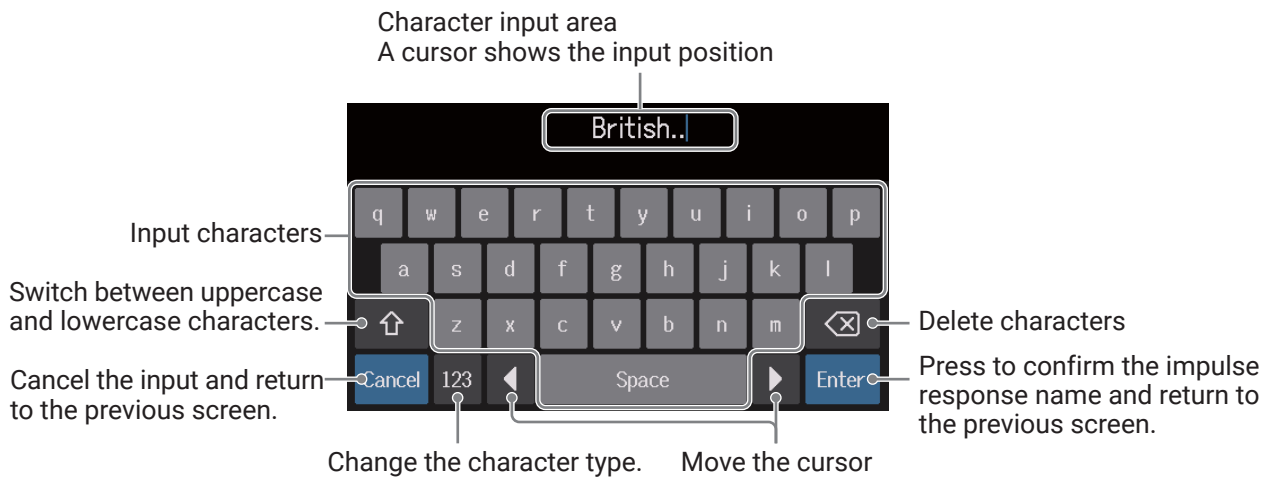

NOTE

The characters and symbols that can be used are as follows.

! # \$ % & ' () + , - . ; = @ [\] ^ _ ` { } ~ (space) A-Z, a-z, 0-9

8. Touch OK.

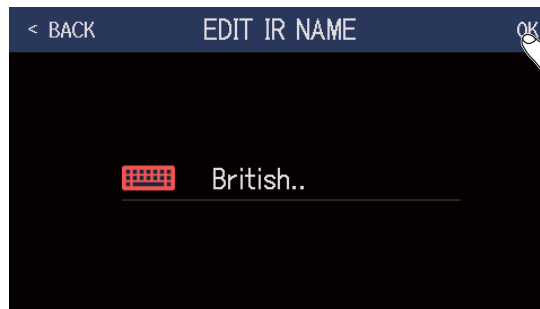

The selected impulse response will be assigned.

Touch  to change the name.

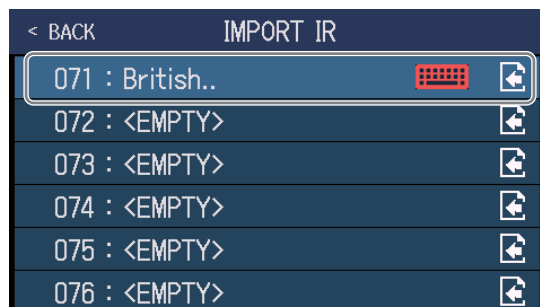

Using audio interface functions

The **G6** can be used as a 2-in/2-out audio interface.

A total of 2 channels of audio signals can be sent from the **G6** after effect processing to a computer.

From a computer, 2 audio signal channels can be input after effect processing.

See [“Signal flow” on page 6](#) for input and output positions.

Installing the driver

■ Windows

1. Download the G6 Driver to the computer from zoomcorp.com.

NOTE

The latest G6 Driver can be downloaded from the above website.

2. Launch the installer and follow its instructions to install the G6 Driver.

NOTE

See the Installation Guide included in the driver package for detailed installation procedures.

■ Mac or iOS/iPadOS device

No driver is necessary for use with a Mac or iOS/iPadOS device.

Connecting to a computer

1. Use a USB cable to connect the **G6** with the computer or iOS/iPadOS device.

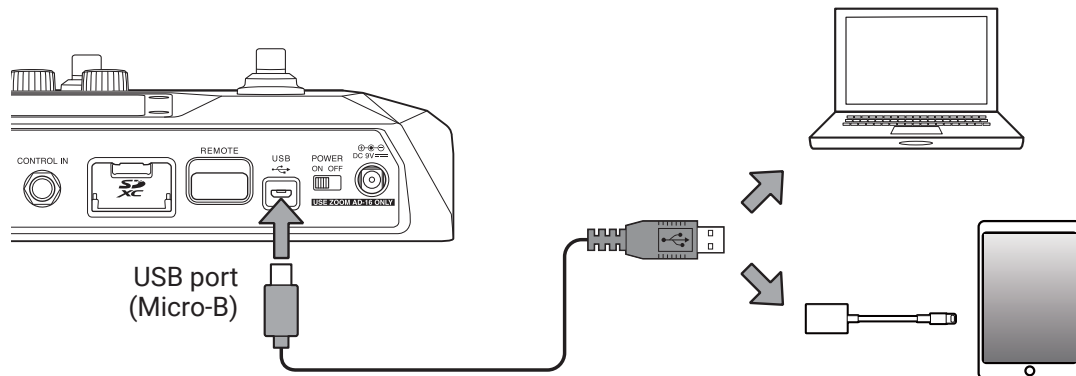

NOTE

Use a Lightning to USB Camera Adapter (or Lightning to USB 3 Camera Adapter) to connect to an iOS/iPadOS device with a lightning connector.

2. Set  to ON.

Turn the **G6** on and connect the iOS/iPadOS device.

If connecting to a computer, skip to step 3.

3. When connecting a computer, set the **G6** as the sound device.

Making audio interface settings

The recording levels can be adjusted and the monitoring balance can be set, for example.

1. Touch  on the Menu Screen.

2. Make audio interface settings.

■ Adjusting the volume (recording level) sent to the computer

Turn  or drag the RECORDING GAIN knob up and down to adjust the recording level. The setting values are shown above the knobs.

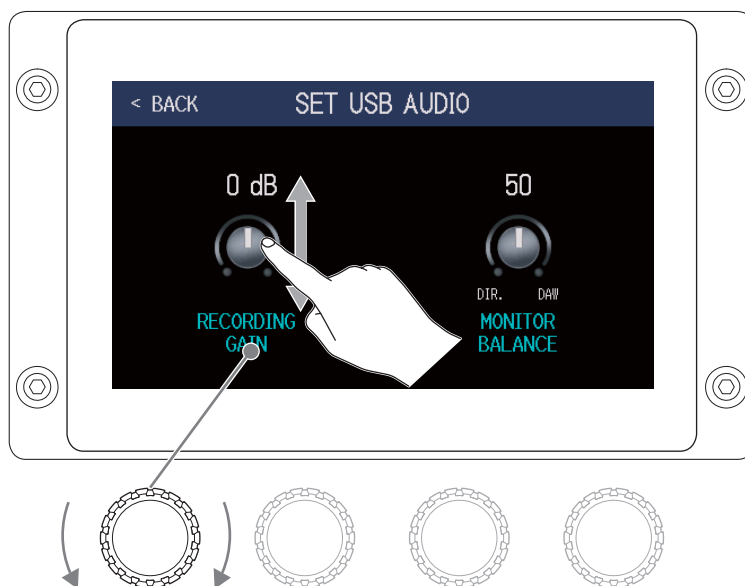

HINT

The setting range is -6 dB to +6 dB.

■ Adjusting the monitoring balance

Turn  or drag the MONITOR BALANCE knob up and down to adjust the balance between the computer output signal and the direct signal (**G6** sound).

The setting values are shown above the knobs.

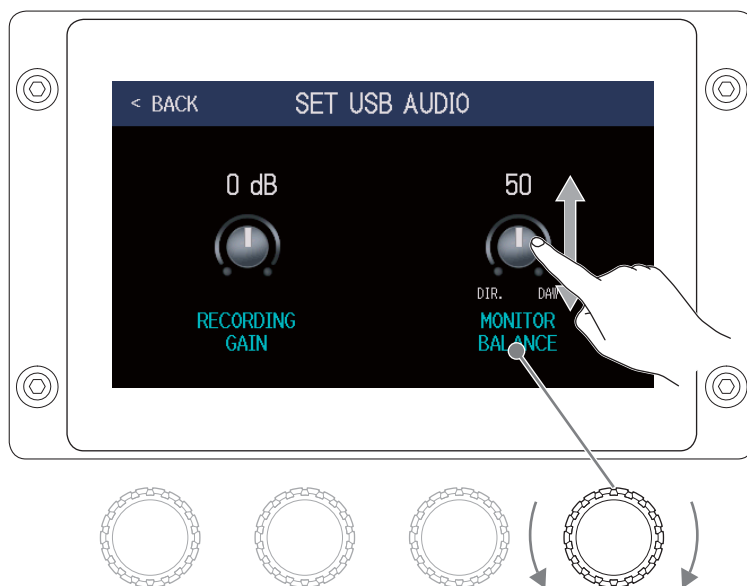

HINT

The setting range is 0–100. The balance will be only the direct signal when set to 0 and only the computer output when set to 100.

Connecting to iOS/iPadOS devices

By connecting a ZOOM BTA-1 or other dedicated wireless adapter, the **G6** can be controlled wirelessly from an iPhone/iPad using the Handy Guitar Lab iOS/iPadOS app.

NOTE

- Before turning the **G6** power on, connect a ZOOM BTA-1 or other dedicated wireless adapter.
- Download the dedicated app from the App Store.

1. While the **G6** power is off, connect a ZOOM BTA-1 or other dedicated wireless adapter.

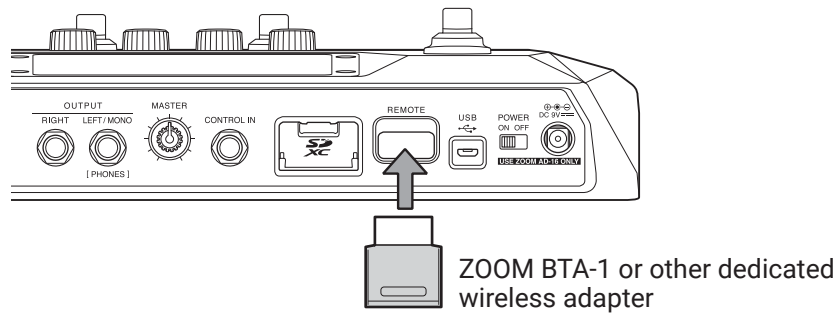

2. Set  to ON.
3. Launch Handy Guitar Lab on the iPhone/iPad.
4. Make the connection on the Handy Guitar Lab settings screen.



HINT

For Handy Guitar Lab setting procedures, see its manual.

Making unit settings

Setting the AUTOSAVE function

When the AUTOSAVE function is ON, patch memories will be saved automatically when their contents are changed.

1. Touch  or  on the Menu Screen.
2. Touch the AUTOSAVE switch to set it to ON/OFF.
Touching this toggles it ON/OFF.

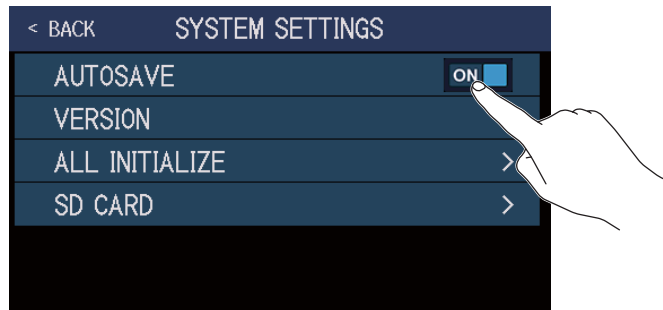

Setting	Explanation
ON	This turns on the AUTOSAVE function.
OFF	This turns off the AUTOSAVE function.

HINT

Patch memories will not be saved automatically if the AUTOSAVE function is OFF.

When the content of a patch memory has been changed,  will appear at the top right of the screen, showing that it is different from the saved settings.

Touch  to open the screen for saving patch memories, and save it as necessary. (→ [“Saving patch memories” on page 56](#))

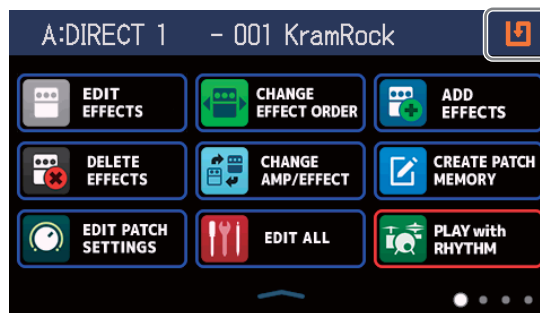

Adjusting the brightness of the touchscreen

The brightness of the touchscreen can be adjusted.

1. Touch  on the Menu Screen.

2. Drag left and right to adjust the brightness of the touchscreen.

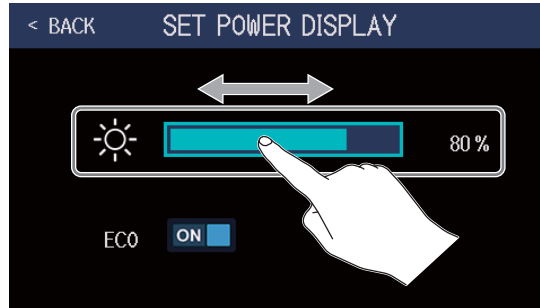

Setting the ECO mode

This function can be used to turn the power off automatically if unused for 10 hours.

1. Touch  on the Menu Screen.

2. Touch the ECO switch to set it to ON/OFF.

Touching this toggles it ON/OFF.

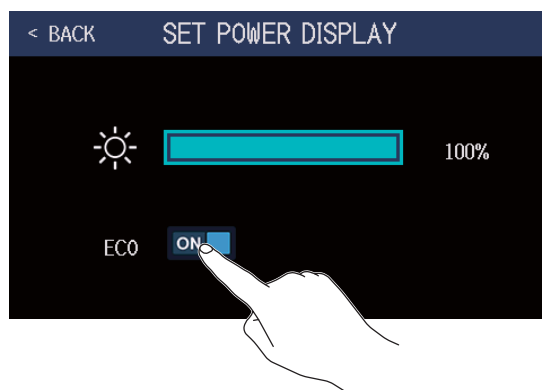

Setting	Explanation
ON	The power will automatically turn off if unused for 10 hours.
OFF	This disables ECO mode.

Managing the firmware

Checking the firmware versions

The firmware versions used by the **G6** can be checked.

- 1. Touch  on the Menu Screen.
- 2. Touch VERSION.

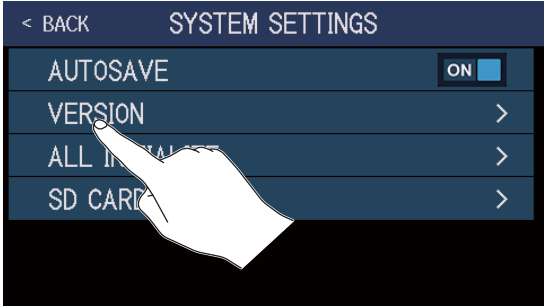

This shows the firmware and preset versions.

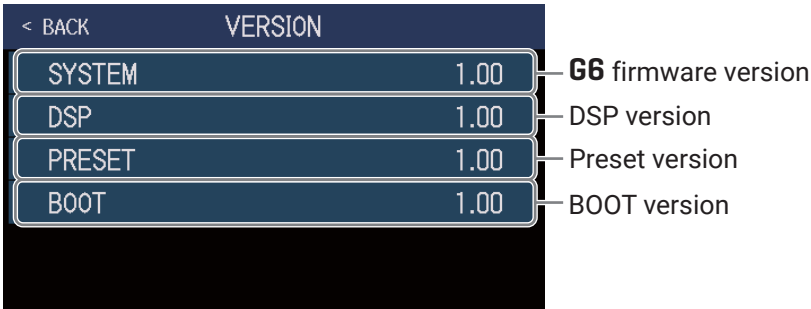

Updating

The **G6** firmware can be updated to the latest versions.

Files for the latest firmware updates can be downloaded from the ZOOM website (zoomcorp.com).

Restoring factory default settings

The factory default settings can be restored.

1. Touch  on the Menu Screen.

2. Touch ALL INITIALIZE.

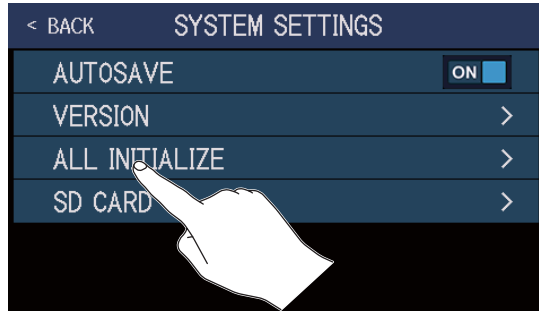

3. Touch ALL INITIALIZE.

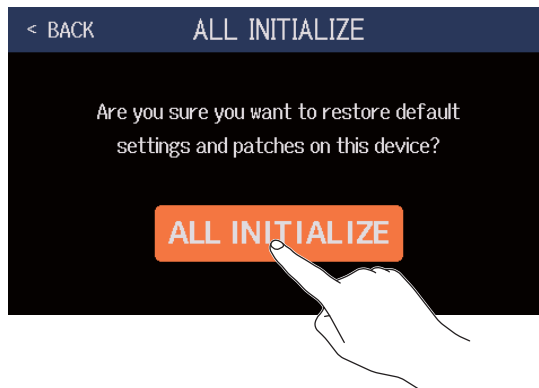

Initialization will be executed, restoring default settings. Then, the **G6** will start up normally.

NOTE

Initialization will overwrite all settings, including patch memories, to their factory defaults. Be certain before using this function.

HINT

To cancel initialization, touch BACK in step 3.

Managing SD cards

Checking SD card information

The open space of SD cards can be checked.

1. Touch  on the Menu Screen.
2. Touch SD CARD.

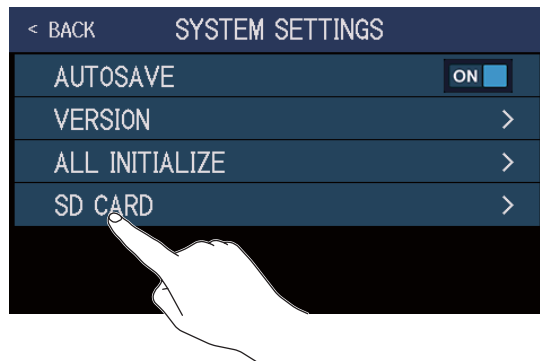

3. Touch SD CARD REMAIN.

This shows the amounts of space open on the SD card.

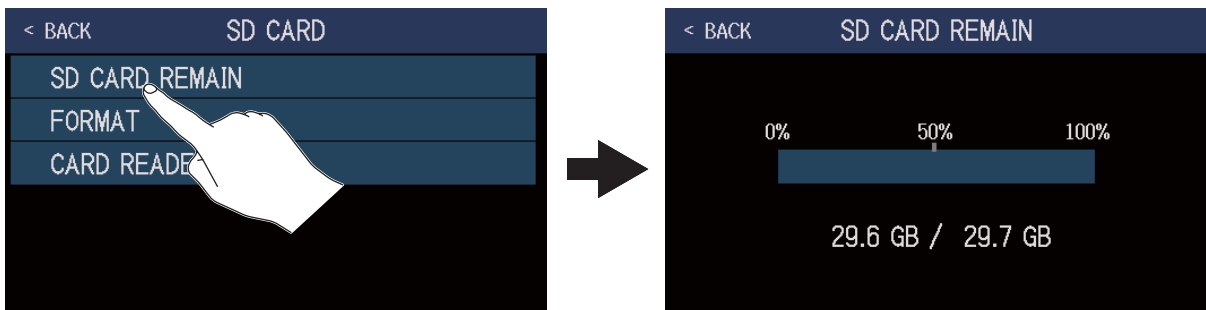

Formatting SD cards

Use the **G6** to format SD cards to maximize their performance.

Before using SD cards that have just been purchased or that have been formatted on a computer, they must be formatted by the **G6**. Be aware that all data previously saved on the SD card will be deleted when it is formatted.

1. Touch  on the Menu Screen.

2. Touch SD CARD.

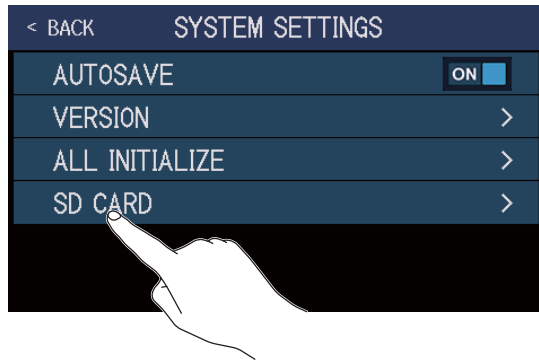

3. Touch FORMAT.

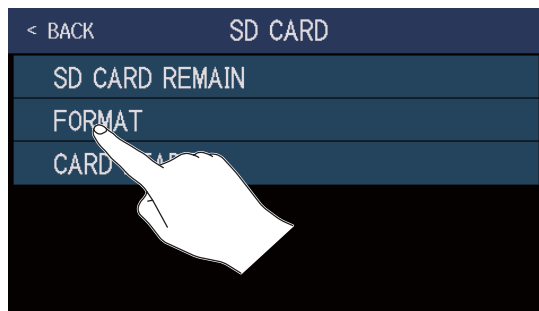

4. Touch Execute.

This formats the card.

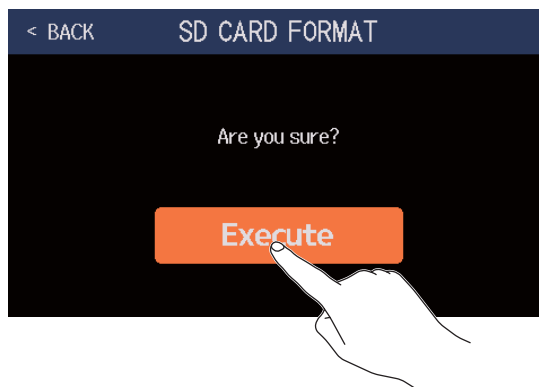

5. Touch OK.

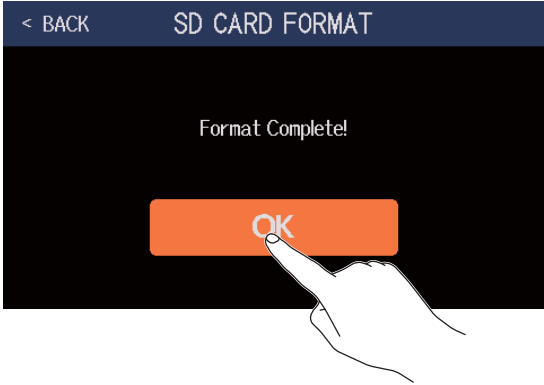

Using as a card reader

The **G6** can be used as a card reader when connected to a computer.

Loops and impulse response data (both your own and from third parties) can be transferred from a computer and loaded in the **G6**.

1. Use a USB cable to connect the **G6** and a computer.

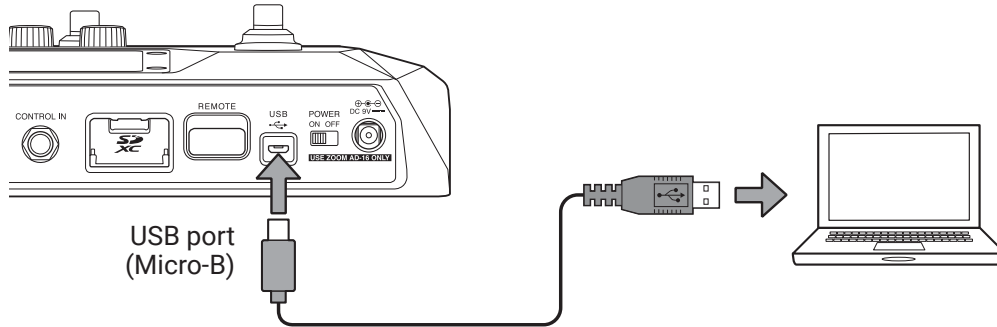

2. Touch  on the Menu Screen.

3. Touch SD CARD.

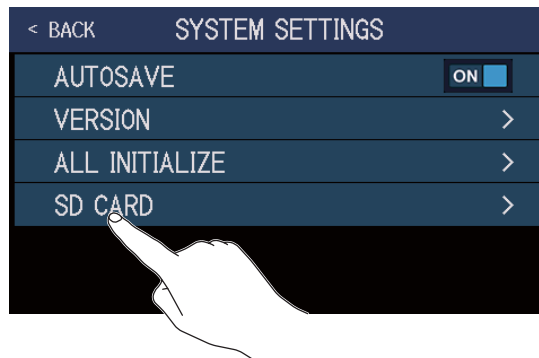

4. Touch CARD READER.

This opens the PC MODE screen.

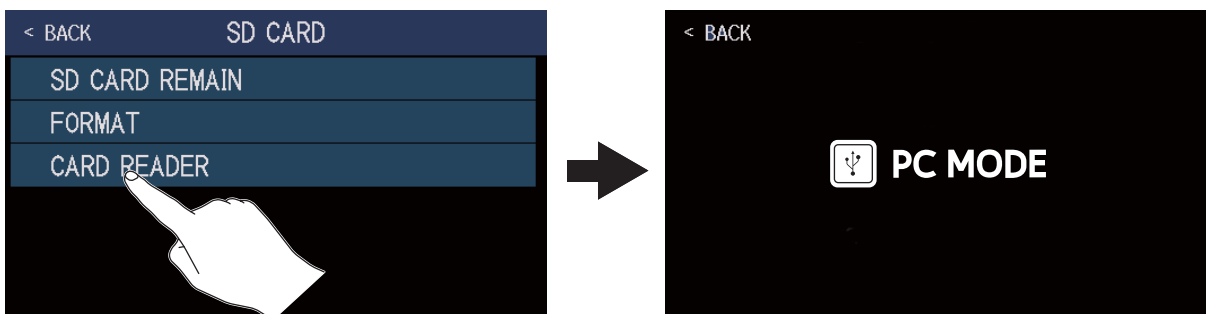

5. Use the computer to transfer the necessary files.

NOTE

When the PC MODE screen is open, other functions cannot be used and the footswitches and parameter knobs are disabled.

G6 folder and file structure

Folders and files are created on the **G6** SD card in the following manner.

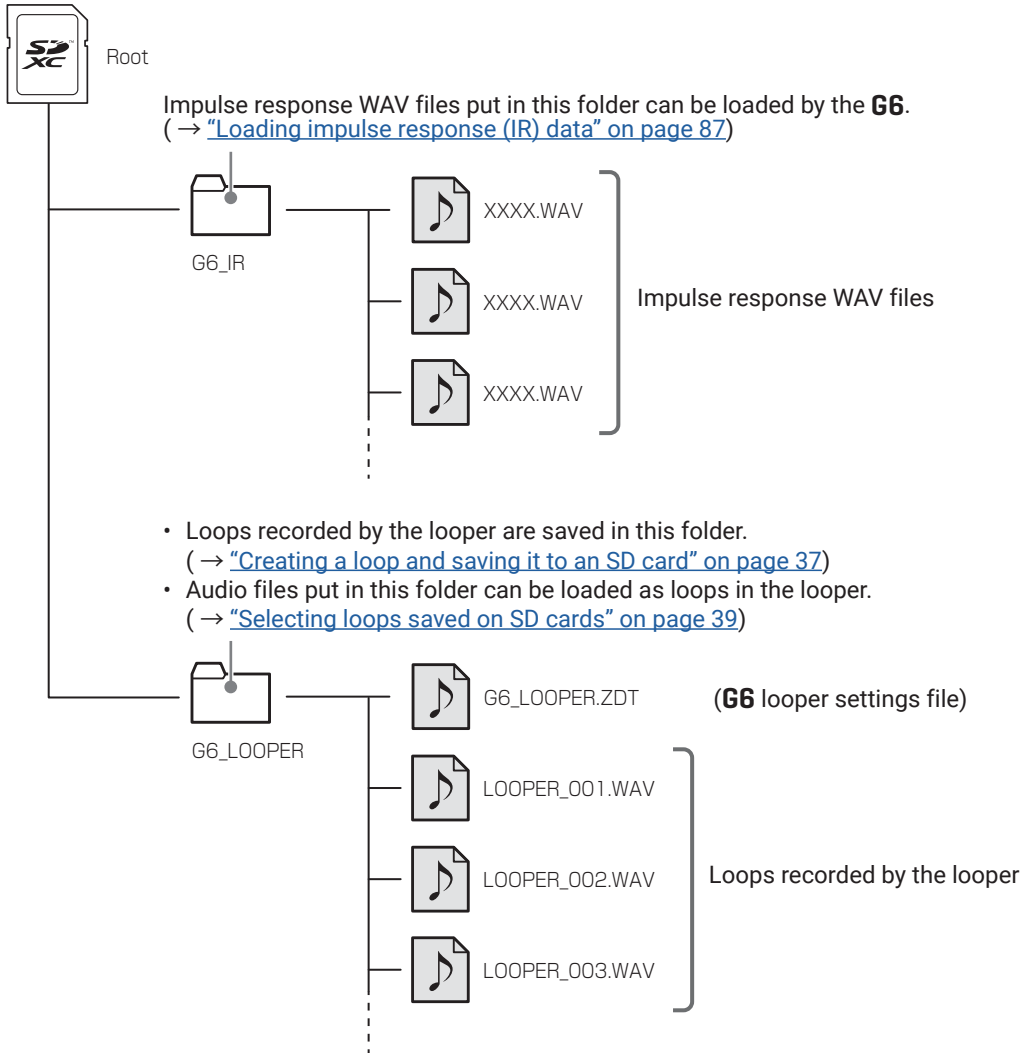

Troubleshooting

The unit will not power on

- Confirm that the POWER switch is set to ON.
- Check the connections. (→ [“Connecting” on page 16](#))

There is no sound or output is very quiet

- Check the connections. (→ [“Connecting” on page 16](#))
- Adjust the levels of the effects. (→ [“Adjusting effects” on page 44](#))
- Adjust the level of the patch memory. (→ [“Setting the patch memory level” on page 53](#))
- Adjust the output volume. (→ [“Adjusting the master level” on page 19](#))
- If you are using an expression pedal to adjust the volume, adjust the pedal position until the volume level is suitable.
- Confirm that the tuner output is not set to “MUTE”. (→ [“Using the tuner” on page 74](#))

There is a lot of noise

- Confirm that a shielded cable is not the cause.
- Use a genuine ZOOM AC adapter. (→ [“Connecting” on page 16](#))

An effect cannot be selected

- If the effect processing power would be exceeded by effect selection, “PROCESS OVERFLOW” will appear on the display and the effect cannot be selected. (→ [“Number of effects in patch memories” on page 43](#))

An expression pedal does not work well

- Select a pedal effect. (→ [“Using the built-in pedal” on page 68](#))
- Check the expression pedal settings. (→ [“Using the built-in pedal” on page 68](#))
- Adjust the expression pedal. (→ [“Adjusting the pedal” on page 70](#))
- Confirm the setting of the connected pedal. (→ [“Using an external pedal” on page 72](#))

The level recorded in the DAW is low

- Check the recording level setting. (→ [“Making audio interface settings” on page 91](#))

Looper cannot record correctly when using an SD cord

- SD cards can become worn out. Speed can decrease after repeated writing and erasing.
- Formatting the card with the **G6** might improve this. (→ [“Formatting SD cards” on page 101](#))
- If formatting an SD card does not improve this, we recommend replacing the card. Please check the list of cards that have been confirmed to work on the ZOOM website.

NOTE

- This is not a guarantee of specific SD card recording performance for the SD/SDHC/SDXC cards that have been confirmed to work.
- This list is provided as a guideline to help find suitable cards.

Specifications

Maximum number of simultaneous effects		9 effects
User patches		240
Sampling frequency		44.1 kHz
A/D conversion		24-bit 128× oversampling
D/A conversion		24-bit 128× oversampling
Signal processing		32-bit
Frequency characteristics		20 Hz – 20 kHz (+0.5 dB/-0.5 dB) (10kΩ load)
Display		4.3" TFT color LCD (480×272)
Inputs	INPUT	Standard mono phone jack Rated input level: -20 dBu Input impedance (line): 500 kΩ
	RETURN	Standard mono phone jack Rated input level: -20 dBu Input impedance (line): 1 MΩ
	AUX IN	Stereo mini jack Rated input level: -10 dBu Input impedance (line): 10 kΩ
Outputs	OUTPUT R	Standard mono phone jack Maximum output level: +11.4 dBu (when output impedance 10 kΩ or higher)
	OUTPUT L/MONO [PHONES]	Standard stereo phone jack Maximum output level: +11.4 dBu (when output impedance 10 kΩ or higher) Headphones 24 mW + 24 mW (at 32Ω load)
	SEND	Standard stereo phone jack Maximum output level: +11.4 dBu (when output impedance 10 kΩ or higher)
Input S/N		123 dB
Noise floor (residual noise)	L/R	-99.3 dBu
	SEND	-99.0 dBu
Control input		FP02M input
Power		AC adapter (9V DC 500mA, center negative) (ZOOM AD-16)
USB		Port: USB 2.0 Micro-B/Supported cable type: Micro-B Guitar Lab: USB 1.1 Full Speed Audio interface: USB 2.0 Full Speed, 44.1kHz/32-bit, 2 in, 2 out • Use a USB cable that supports data transfer. USB bus power is not supported.
SD card	Standards	Cards that support SD/SDHC/SDXC specifications (Class 10 or higher)
	LOOPER	44.1kHz/16-bit stereo WAV
	IR	44.1–192kHz, 16/24/32-bit WAV
REMOTE		ZOOM BTA-1 or other dedicated wireless adapter
External dimensions		228 mm (D) × 418 mm (W) × 65 mm (H)
Weight		1.94 kg

Note: 0 dBu = 0.775 V



ZOOM CORPORATION

4-4-3 Kanda-surugadai, Chiyoda-ku, Tokyo 101-0062 Japan
zoomcorp.com

Z2I-4197-01