



AC-2

ACOUSTIC CREATOR

Operation Manual

Thank you very much for purchasing a **ZOOM AC-2** (hereafter, "**AC-2**").

Please read this manual carefully to fully understand the functions of the **AC-2** so that you can make the most of it for many years.

Keep this manual in a convenient location and refer to it as necessary.

Contents

| | | | |
|-------------------------------------|----|--|----|
| Usage and Safety Precautions | 2 | Adjusting the reverb | 10 |
| Introduction | 3 | Using the boost function | 11 |
| Names of parts | 4 | Using the anti-feedback function | 11 |
| Connecting a guitar | 6 | Using the tuner | 12 |
| Connecting output devices | 6 | Setting the type of batteries used | 12 |
| Turning the power on | 7 | Connecting audio equipment | 13 |
| Setting the pickup type | 8 | Updating the firmware | 14 |
| Setting the volume..... | 8 | Troubleshooting | 15 |
| Setting the source guitar type..... | 9 | Specifications | 15 |
| Adjusting the equalization | 10 | | |

© 2017 ZOOM CORPORATION

Copying or reprinting this manual in part or in whole without permission is prohibited.

Manufacturer names and product names are trademarks or registered trademarks of their respective owners.

The names are used only to illustrate sonic characteristics and do not indicate any affiliation with the Zoom Corporation.

Usage and Safety Precautions

Safety Precautions

In this operation manual, symbols are used to highlight warnings and cautions that you must read to prevent accidents. The meanings of these symbols are as follows.

 **Warning** Something that could cause serious injury or death.

 **Caution** Something that could cause injury or damage to the equipment.



Other symbols used

 An action that is mandatory.



 An action that is prohibited.

Warnings

Operation using an AC adapter

-  Always use an AC adapter that is 9V DC 500mA center negative (ZOOM AD-16).
-  Do not do anything that could exceed the ratings of outlets and other electrical wiring equipment. Before using the equipment in a foreign country or other region where the electrical voltage differs, always consult with a shop that carries ZOOM products and use the appropriate AC adapter.

Operation with batteries



-  Use 2 commercially-available 1.5V AA batteries (alkaline or nickel metal hydride).
-  Carefully study the warning indications of the batteries before use.
-  Always keep the battery cover closed during use.

Alterations





-  Do not open the case or modify the product.

Cautions



Product handling

-  Do not drop, bump or apply excessive force to the unit.
-  Be careful not to allow foreign objects or liquids to enter the unit.



Operating environment

-  Do not use in extremely high or low temperatures.
-  Do not use near heaters, stoves and other heat sources.
-  Do not use in very high humidity or where it could be splashed by water.
-  Do not use in places with frequent vibrations.
-  Do not use in places with much dust or sand.

AC adapter handling



-  When disconnecting the power plug from an outlet, always pull on the plug itself.
-  Disconnect the power plug from the outlet when the unit will not be used for a long time and whenever there is lightning.

Battery handling

-  Install batteries with the correct +/- orientations.
-  Use the specified batteries. Do not use new and old batteries together. Do not use batteries of different brands or types together.

-  Remove the batteries when the unit will not be used for a long time. If a leak occurs, thoroughly wipe the battery case and battery terminals to remove the leaked fluid.

Connection cables and input/output jacks

-  Always turn the power OFF for all equipment before connecting any cables.
-  Always disconnect all connection cables and the AC adapter before moving the unit.

Volume

-  Do not use at a loud volume for a long time.

Usage Precautions

Interference with other electrical equipment

In consideration of safety, the **AC-2** has been designed to minimize its emission of electromagnetic waves and to suppress interference from external electromagnetic waves. However, equipment that is very susceptible to interference or that emits powerful electromagnetic waves could result in interference if placed nearby. If this occurs, place the **AC-2** and the other device farther apart.

With any type of electronic device that uses digital control, including the **AC-2**, electromagnetic interference could cause malfunction, corrupt or destroy data and result in other unexpected trouble. Always use caution.

Cleaning

Use a soft cloth to clean the exterior of the unit if it becomes dirty. If necessary, use a damp cloth that has been wrung out well to wipe it.

Never use abrasive cleansers, wax or solvents such as alcohol, benzene or paint thinner.

Breakdown and malfunction

If the unit becomes broken or malfunctions, immediately turn the power off, disconnect the AC adapter and disconnect other cables. Contact the store where you bought the unit or ZOOM service with the following information: product model, serial number and specific symptoms of breakdown or malfunction, along with your name, address and telephone number.

FCC regulation warning (for U.S.A.)

Note: This equipment has been tested and found to comply with the limits for a Class B digital device, pursuant to Part 15 of the FCC Rules. These limits are designed to provide reasonable protection against harmful interference in a residential installation. This equipment generates, uses and can radiate radio frequency energy and, if not installed and used in accordance with the instructions, may cause harmful interference to radio communications. However, there is no guarantee that interference will not occur in a particular installation. If this equipment does cause harmful interference to radio or television reception, which can be determined by turning the equipment off and on, the user is encouraged to try to correct the interference by one or more of the following measures:

- Reorient or relocate the receiving antenna.
- Increase the separation between the equipment and receiver.
- Connect the equipment into an outlet on a circuit different from that to which the receiver is connected.
- Consult the dealer or an experienced radio/TV technician for help.

For EU Countries

 Declaration of Conformity

Introduction

Acoustic remodeling that restores body tone

The 16 source guitar type presets simulate the sonic characteristics of a variety of acoustic guitars with different body shapes and material properties. By choosing a source guitar according to the guitar that you are using, you can share the original rich and beautiful tone of your acoustic guitar with audiences during live performances.

High-quality preamp that can be used with many pickups

The preamp was designed especially for acoustic guitars and can be used with input from piezoelectric, magnetic and passive pickups. This acoustic guitar preamp provides a range of key features, including a 3-band EQ that can be used to adjust the tone according to the environment and a super-low-noise design with a 120 dB S/N ratio and a -100 dBu noise floor.

Anti-feedback function with minimal effect on tone quality

The anti-feedback function can quickly and effectively eliminate feedback during a performance.

Clean boost of up to 9 dB

The boost function can reduce the volume differences of fingerpicking, strumming chords and other guitar playing techniques, as well as increase amplification during solos.

Names of parts

■ Front Panel

Names of parts

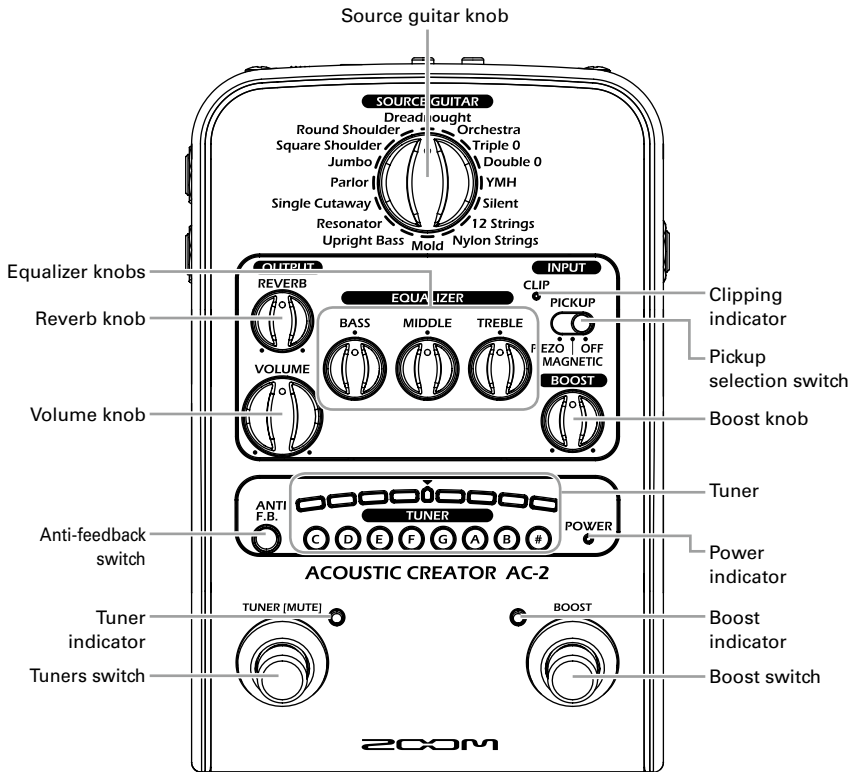

■ Rear Panel

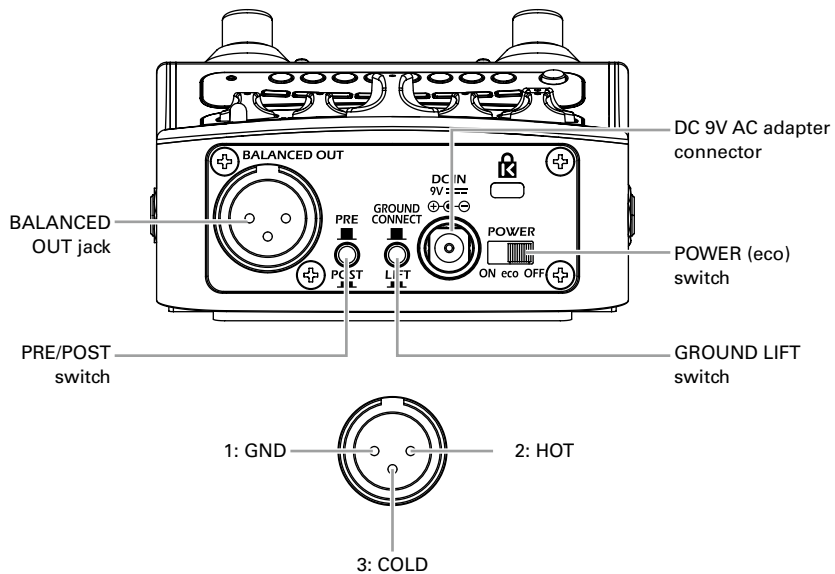

■ Left Panel

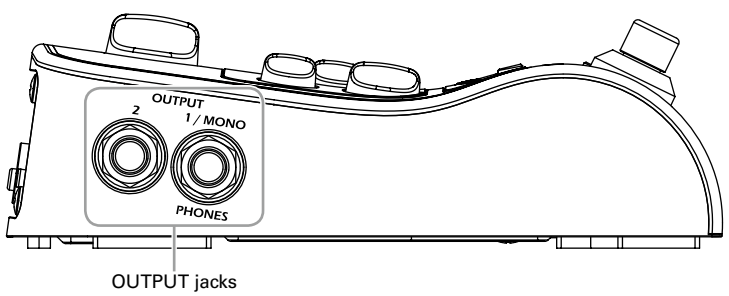

■ Right panel

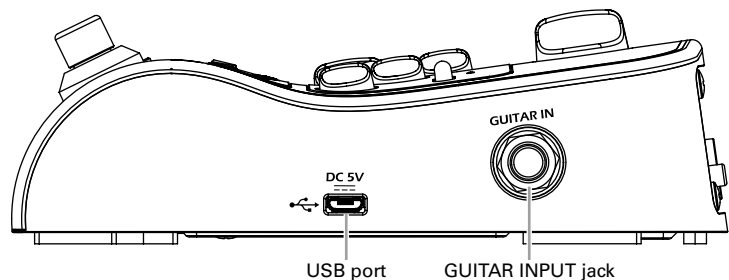

Connecting a guitar

Use a shielded cable to connect a guitar to the **AC-2**.

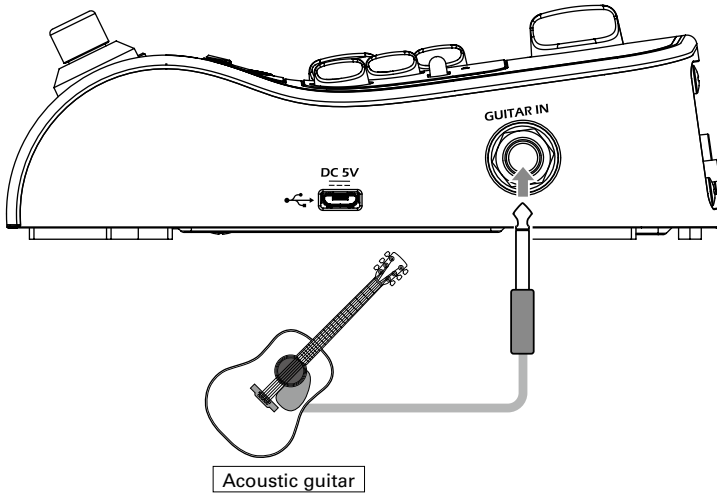

Connecting output devices

Connect the **AC-2** to a PA system, acoustic guitar amp or other output device. To use headphones, connect them to the 1/MONO/PHONES jack.

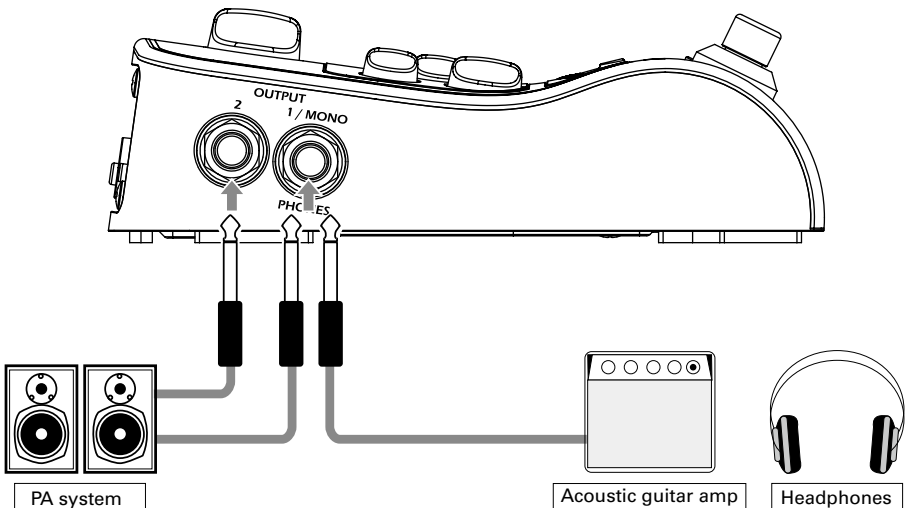

Turning the power on

- Minimize the volume of the output device.



- Prepare the power source.

■ Using an AC adapter

Connect the AD-16 adapter to the **AC-2**.

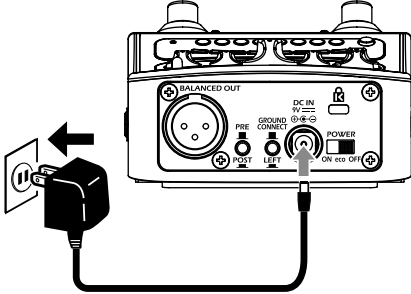

- Set the power switch to "ON" or "eco".

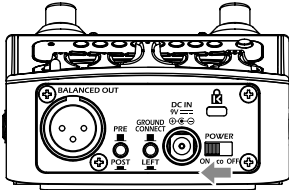

Power indicator
(front panel)

Open the battery cover on the bottom of the unit and install batteries into the battery compartment.

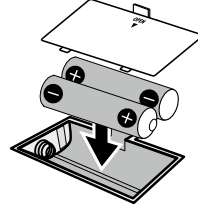

NOTE

The power indicator lights red when the remaining battery power becomes low.
Replace the batteries with new ones.



- Turn the output device on, and raise its volume.

HINT

You can also use a USB cable to connect the **AC-2** to a computer and power it with USB bus power.

POWER switch "eco" setting

The power will automatically turn off if unused for 10 hours.

If you want the power to stay on always, set the POWER switch to "ON".

Setting the pickup type

Adjust the operation of the **AC-2** according to the type of pickup used.

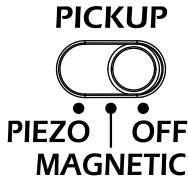

- **PIEZO:**
This makes adjustments suitable for piezo pickups.
- **MAGNETIC:**
This makes adjustments suitable for magnetic pickups.
- **OFF:**
This turns off the pickup adjustment function.

Setting the volume

Turn the **VOLUME** knob to adjust the volume.



When using active pickups:

Set the **VOLUME** knob to the center position as the reference level.



When using passive pickups:

Set the **VOLUME** knob to the 3 o'clock position as the reference level.









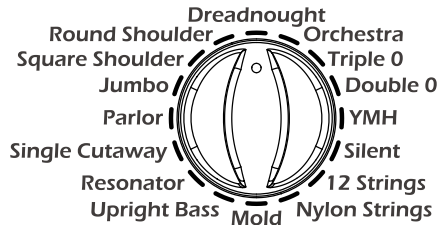







NOTE

If the clipping indicator lights red, lower the output volume from the pickup.

Setting the source guitar type

By choosing a source guitar according to the guitar that you are using, body tone lost when using a pickup can be re-created, restoring the original rich and beautiful tone of your acoustic guitar.



| | |
|---|--|
| Round Shoulder | Dreadnought |
|  Best for guitars with round shoulders, such as the Gibson J series. |  Best for dreadnought guitars, such as the Martin D series. |
| Square Shoulder | Orchestra |
|  Best for guitars with square shoulders, such as the Gibson Hummingbird. |  Best for orchestra guitars, such as the Martin OM series. |
| Jumbo | Triple 0 |
|  Best for jumbo body guitars, such as the Gibson SJ series. |  Best for 000 guitars, such as the Martin 000 series. |
| Parlor | Double 0 |
|  Best for parlor guitars, such as the Gibson L series. |  Best for 00 guitars, such as the Martin 00 series. |
| Single Cutaway | YMH |
|  Best for single cutaway guitars like those made by Taylor. |  Best for special jumbo body guitars, such as the YAMAHA LL series. |
| Resonator | Silent |
|  Best for resonator guitars. |  Best for silent guitars that do not have resonant body cavities. |
| Upright Bass | 12 Strings |
|  Best for upright basses. |  Best for 12-string guitars. |
| Mold | Nylon Strings |
|  Best for molded resin guitars like those made by Ovation. |  Best for classical guitars that use nylon strings. |

Adjusting the equalization

Turn the BASS, MIDDLE and TREBLE equalizer knobs to adjust the final output sound.

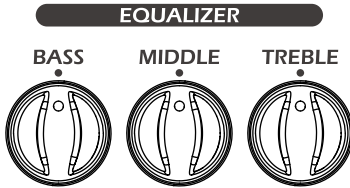

Set each equalizer knob to its center position for a flat response first before adjusting the tone.

- **BASS:**
Adjust to boost or cut low frequencies.
Boost to emphasize the body tone. Cut if low frequencies are too loud when strumming.
- **MIDDLE:**
Adjust to boost or cut middle frequencies.
Boost to add warmth to the tone. Cut to make the tone more powerful, emphasizing the attack.
- **TREBLE:**
Adjust to boost or cut high frequencies.
Boost to emphasize the ringing of the strings. Cut if high frequencies are too loud.

Adjusting the reverb

Turn the REVERB knob to add a reverb effect to the sound of the acoustic guitar, increasing its width and depth.



Keep the original tone of the acoustic guitar in mind as you adjust the reverb volume.

Using the boost function

Turn the boost knob to amplify the volume during solos or to change the volume when switching between strumming and fingerpicking. Use the BOOST switch to turn the boost ON and OFF.

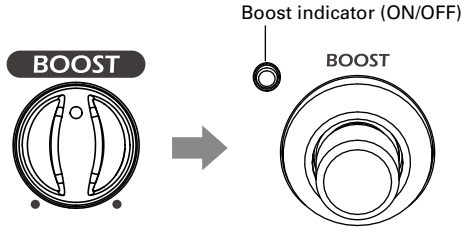

NOTE

If the sound distorts when the boost is on, turn the VOLUME knob to adjust the volume.

Using the anti-feedback function

Press the anti-feedback switch to find and cut the frequency band that is causing feedback to reduce it.

ANTI F.B.



The feedback switch will blink while the feedback frequency band is being found. When the frequency band has been found, it will light and the anti-feedback function will become active.

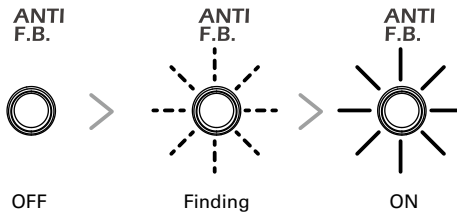

NOTE

Press the anti-feedback switch again to turn the anti-feedback function off.

Using the tuner

Press the tuner switch to turn the tuner ON and OFF. Play the open string that you want to tune and the closest pitch name LED will light. The LED meter will show the pitch error.

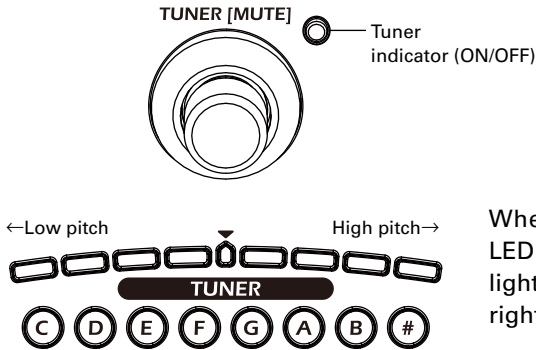

When the pitch is confirmed, the LED at the center of the meter will light green and LEDs to the left and right will light red.

NOTE

The output is muted when the tuner is on. The standard pitch for middle A is fixed to 440Hz.

Setting the type of batteries used

Set the type of battery used by the **AC-2** so that the remaining battery charge can be indicated accurately.

- Turn the power ON while pressing . (The boost indicator blinks.)



- Press  to set the type of battery used.



Lit green: Alkaline batteries
Lit red: Nickel metal hydride batteries

Power indicator
(front panel)



- Press  to confirm the setting. (The boost indicator stays lit.)

Connecting audio equipment

The **AC-2** can be connected to a mixer, recording device or other audio equipment that adjusts the sound balance.

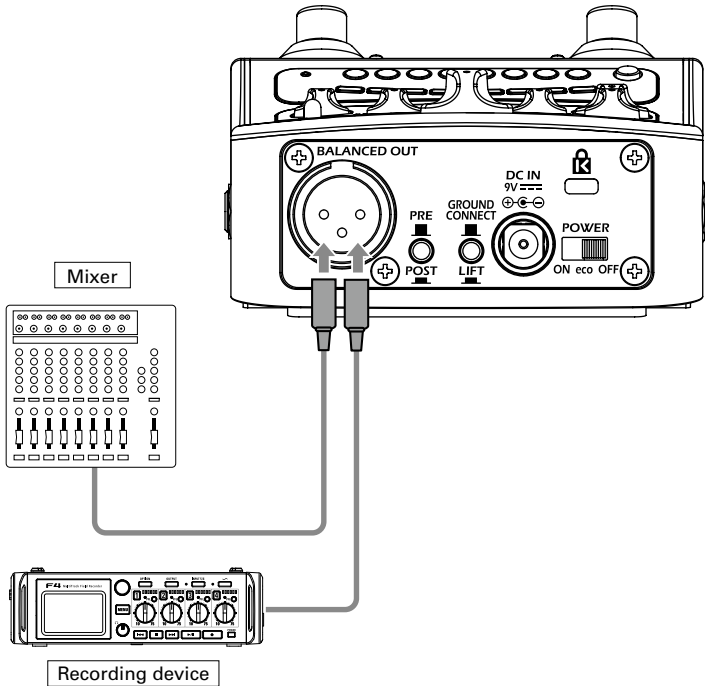

PRE



POST



Set when the signal is output from the BALANCED OUT jack.

- **PRE** (button up): Output before processing by the **AC-2**.
- **POST** (button down): Output after processing by the **AC-2**.

**GROUND
CONNECT**



LIFT

The BALANCED OUT jack can be connected or disconnected from the ground.

- **CONNECT** (button up): Connect to the ground pin.
- **LIFT** (button down): Disconnect the grounding pin from the ground. This is effective if noise is caused by a ground loop.

Updating the firmware

To download the latest firmware, visit the ZOOM website (<http://www.zoom.co.jp/>).

- Use a USB cable to connect the **AC-2** to a computer.

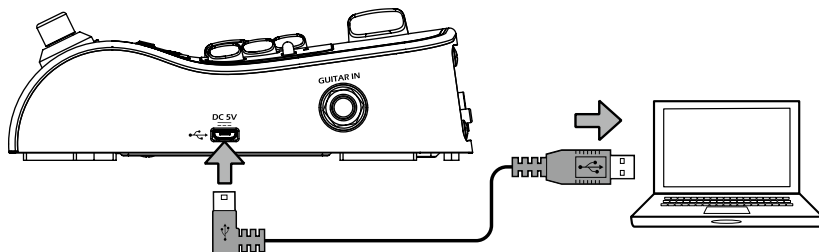

- While pressing both **TUNER [MUTE]** and **ANTI F.B.**, turn the POWER switch ON.



- Launch the firmware update application on the computer and start the update.



- The **AC-2** clipping indicator lights orange while the update is being executed.



NOTE

Do not disconnect the USB cable during a firmware update.

HINT

See the ZOOM website (<http://www.zoom.co.jp/>) for firmware update application instructions.



- The **AC-2** clipping indicator lights green when the update completes.



- Set the power switch to "OFF".

Troubleshooting

The unit will not power on

- Confirm that the POWER switch is set to ON.
- If using batteries, confirm that they are still charged.

There is no sound or output is very quiet

- Check the connections. (→ P6, P13)
- Sound will not be output in the tuner is on. (→ P12)

There is a lot of noise

- Confirm that the shielded cable is not the cause.
- Use a genuine ZOOM AC adapter.

The sound distorts strangely or has an odd timbre

- Adjust the amount of boost amplification. (→ P11)
- Set the pickup selection correctly for the type of pickup. (→ P8)

Batteries lose their charge quickly

- Confirm that you are not using manganese batteries. Alkaline batteries should provide about 3 hours of continuous operation.
- Confirm that the battery type setting is correct. (→ P12)

Specifications

| | |
|-------------------------------------|---|
| Source guitars | 16 types |
| Sampling frequency | 44.1 kHz |
| A/D conversion | 24-bit 128x oversampling |
| D/A conversion | 24-bit 128x oversampling |
| Signal processing | 32-bit |
| Frequency characteristics | 20 Hz–20 kHz (+1 dB/–3 dB) (10 kΩ load) |
| Input | Standard mono phone jack Rated input level: –20 dBu Input impedance: 10 MΩ |
| Outputs 1/MONO/PHONES | Standard stereo phone jack (combined line/headphone) Maximum output level: Line +7 dBu (10 kΩ or more output impedance) Headphones 8 mW + 8 mW (32 Ω load) |
| 2 | Standard mono phone jack Maximum output level: Line +7 dBu (10 kΩ or more output impedance) |
| BALANCED OUT | XLR jack Output impedance: 100 Ω (HOT-GND, COLD-GND), 200 Ω (HOT-COLD) PRE/POST (switchable) GND LIFT (switchable) |
| S/N (equivalent input noise) | 120 dBu |
| Noise floor (residual noise) | –100 dBu |
| Power | AC adapter: 9V DC 500 mA center negative (ZOOM AD-16) Batteries: 2 AA (about 3 hours continuous operation time using alkaline batteries) |
| External dimensions | 158 mm (D) × 107 mm (W) × 52 mm (H) |
| USB | USB MIDI USB Micro-B |
| Weight | 570 g (Not including batteries) |

Note: 0 dBu = 0.775 V

zoom[®]

ZOOM CORPORATION

4-4-3 Kanda-surugadai, Chiyoda-ku, Tokyo 101-0062 Japan

<http://www.zoom.co.jp>