

**USER MANUAL**

**\_POLYBRUTE**

**ARTURIA**

**\_The sound explorers**

# Special Thanks

---

## DIRECTION

---

Frédéric Brun                      Philippe Cavenel

---

## ENGINEERING

---

Bruno Pillet	Marc Antigny	Lionel Ferragut	Valentin Lepetit
Thierry Chatelain	Alexandre Adam	Nadine Lantheaume	Benjamin Reynier
Thomas Aubert	Loris De Marco	Nicolas Dubois	Vivien Henry
Osée Rajaiah	Kevin Molcard	Jérôme Blanc	
Olivier Delhomme	Timothee Behety	Aurore Baud	

---

## DESIGN

---

Thierry Chatelain	Sébastien Rochard	Frédéric Brun
Bruno Pillet	DesignBox	Julien Viannenc

---

## SOUND DESIGN

---

Jean-Michel Blanchet	Euan Dickinson	Olivier Grall	Matt Pike
Victor Morello	Michael Geyre	Lily Jordy	
Clément Bastiat	Simon Gallifet	Kenny Larkin	
Olivier Briand	Boele Gerkes	Tobias Menguser	

---

## QUALITY ASSURANCE

---

Arnaud Barbier	Florian Marin	Julien Viannenc
Germain Marzin	Adrien Soyer	

---

## USER MANUAL

---

Randy Lee (Author)	Camille Dalemans	Minoru Koike	Jose Gerardo Rendon
Stephen Fortner (updates)	Are Leistad	Charlotte Metais	Holger Steinbrink
Mike Metlay (updates)	Vincent Le Hen	Jimmy Michon	

---

## BETA TESTING

---

Marco Correia	Boele Gerkes	Are Leistad	T.J. Trifeletti
Jason Cooper	Jason Gibbins	Terry Marsden	Börries Wendling
Jean-Marc Gendreau	Randy Lee	Davide Puxeddu	

© ARTURIA SA - 2023 - All rights reserved.  
26 avenue Jean Kuntzmann  
38330 Montbonnot-Saint-Martin - FRANCE  
[www.arturia.com](http://www.arturia.com)

Information contained in this manual is subject to change without notice and does not represent a commitment on the part of Arturia. The software described in this manual is provided under the terms of a license agreement or non-disclosure agreement. The software license agreement specifies the terms and conditions for its lawful use. No part of this manual may be reproduced or transmitted in any form or by any purpose other than purchaser's personal use, without the express written permission of ARTURIA S.A.

All other products, logos or company names quoted in this manual are trademarks or registered trademarks of their respective owners.

**Product version: 3.0.0**

***Revision date: 19 September 2023***

# Thank you for purchasing the Arturia PolyBrute!

This manual covers the features and operation of Arturia's **PolyBrute**.

In this package you will find:

- One PolyBrute analog synthesizer
- One Quick Start Guide
- The product safety manual. Please read this before using the PolyBrute.
- One IEC AC power cord.

**Be sure to register your PolyBrute as soon as possible!** There is a sticker on the bottom panel that contains the serial number of your unit. This is required during the online registration process. You may want to record these elsewhere or take a photo of the sticker in case it becomes damaged.

Registering your PolyBrute provides the following benefits:

- It enables you to download the PolyBrute user manual and the latest version of the companion PolyBrute Connect software
- It allows you to receive special offers restricted to PolyBrute owners, such as 3rd-party sound banks, etc.

# Special Message Section

## Specifications Subject to Change:

The information contained in this manual is believed to be correct at the time of printing. However, Arturia reserves the right to change or modify any of the specifications without notice or obligation to update the hardware that has been purchased.

## IMPORTANT:

1. The product and its software, when used in combination with an amplifier, headphones or speakers, may be able to produce sound levels that could cause permanent hearing loss. DO NOT operate for long periods of time at a high level or at a level that is uncomfortable. If you encounter any hearing loss or ringing in the ears, you should consult an audiologist.
2. It is important that you read the included Safety Manual thoroughly and fully understand the instructions.

## NOTICE:

Service charges incurred due to a lack of knowledge relating to how a function or feature works (when the product is operating as designed) are not covered by the manufacturer's warranty, and are therefore the owner's responsibility. Please study this manual carefully and consult your dealer before requesting service.

## Precautions include, but are not limited to, the following:

1. Read and understand all the instructions.
2. Always follow the instructions on the instrument.
3. Before cleaning the instrument, always remove the AC cable. When cleaning, use a soft and dry cloth. Do not use gasoline, alcohol, acetone, turpentine or any other organic solutions; do not use a liquid cleaner, spray or cloth that's too wet.
4. Do not place the instrument in an unstable position where it might accidentally fall over.
5. Do not place heavy objects on the instrument. Do not place the instrument near a heat vent at any location with poor air circulation.
6. Do not open or insert anything into the instrument that may cause a fire or electrical shock.
7. Do not spill any kind of liquid onto the instrument.
8. Always take the instrument to a qualified service center. You will invalidate your warranty if you open and remove the cover, and improper assembly may cause electrical shock or other malfunctions.
9. Do not use the instrument with thunder and lightning present; otherwise it may cause long distance electrical shock.
10. If Safeguard Fuse for internal AC input wire needs to be replaced, swap the fuse with the following technical characteristics : F3.15A, 250v AC.
11. Do not expose the instrument to hot sunlight. The operating temperature range of the instrument should be 15°-35° C (59°-95° F).
12. Do not use the instrument when there is a gas leak nearby.
13. Arturia is not responsible for any damage or data loss caused by improper operation of the instrument.

# Introduction

## Congratulations on your purchase of the Arturia PolyBrute!

PolyBrute is the logical progression of the Brute series of synthesizers. It inherits a decade of development and refinement that began with the Micro- and MiniBrute synths, and later thrilled the world with the release of the MatrixBrute. These synthesizers claimed new territory through their power, elegance and simplicity. And the *sound* of those instruments: fat, smooth, aggressive, unique... It seemed there was nothing a musician or sound designer couldn't do if they had one or more of these beautiful Brutes in the studio.

But wonderful as they are, they are monophonic (mostly; the MatrixBrute has a three-voice paraphonic mode). Speculation has run wild for years: Will Arturia make a polyphonic analog synthesizer someday?

Yes, yes, yes, yes, yes, and proudly, yes. Enter the PolyBrute, with six killer analog voices, two luscious filters, and much, much more:

- 6-voice polyphonic analog synthesizer with split/layer capability
- 5-octave, velocity-sensitive keyboard with duophonic aftertouch and adjustable curves
- Continuous deep/subtle sound transformations through a global morphing feature
- Poly, Mono, and Unison modes with selectable voice allocation
- Chord memory mode for triggering a chord from a single note
- Polyphonic sequencer and arpeggiator onboard
- Motion recorder captures the movement of one control for one-shot or looped playback
- Mixer section can route oscillators and noise generator through one or both filters
- Portamento/Glide with continuous and chromatic options
- Built-in digital effects: Chorus, Phaser, Flangers, Ensemble, Ring Mod, Distortions, Delay, and Reverb
- Effects can be used as insert or send effects, or bypassed for a pure analog signal path
- Eight EQ presets
- Two independent displays provide real-time feedback on edits to envelopes, filter curves, and many other parameters
- 768 patch memories, arranged in 8 banks of 96
- Snapshot: preserve up to 5 edits in progress, with instant recall
- A potentially infinite number of patches can be imported/exported with the PolyBrute Connect

## Voice engine

- Each voice has two oscillators, plus a sub-oscillator for VCO 2
- Powerful waveform sculpting features, such as variable oscillator sync, wavefolding (i.e. Metalizer)
- Two independent filters per voice
  - Steiner: 12dB per octave (continuous multimode), plus our famous Brute Factor for extra grit
  - Ladder: 24dB per octave with distortion
  - Use them in series, parallel, or any blend of the two
  - Master Cutoff control to sweep both filters at once
  - Filter FM (VCO 2 > VCF 1, Noise > VCF 2)
- Continuous soft > hard oscillator sync (2 > 1)
- Morph: Every patch has two sounds (A+B); most parameters can morph between an A and B setting. Details are [here](#).

- Three syncable, multi-waveform LFOs per voice
- Three loopable envelopes: VCF/VCA (ADSR), Mod (DADSR)
- Multi-colour noise generator
- Powerful, easy-to-use modulation matrix
- Variable “Analog Accuracy” to recreate the character of vintage synthesizers

### Performance controls

- Morphée, a 3-D controller that can modulate parameters along the X, Y, and Z axes simultaneously
- Velocity and Aftertouch (pressure sensitivity)
- Ribbon controller
- Pitch and Modulation wheels
- Octave buttons can shift keyboard range +/- 2 octaves from center
- One Sustain pedal input and two Expression pedal inputs (pedals optional)

### Sequencer/Arpeggiator

- Polyphonic up to 6 notes
- Record and play back up to 3 modulation tracks
- Sequences can hold up to 64 steps; arpeggios can have up to 32 steps
- Swing and time division settings
- Multiple playback modes and directions
- Convert arpeggios to sequences
- Step record/editing
- Matrix Arpeggiator mode for constructing complex arpeggios
- Tempo range 30-240 bpm

### PolyBrute Connect

- Free, downloadable editor/librarian app (macOS, Windows) for registered PolyBrute owners
- Two-way editing: turn a knob, the editor follows, and vice-versa
- Adjust internal settings quickly, such as envelope curves, timbrality settings, etc.
- Librarian features (organize, search by type and style, export, import, share with other users)
- Doubles as a plug-in for DAW control of external PolyBrute parameters

### Other hardware features

- Stereo outputs
- MIDI In/Out/Thru connectors
- Clock In/Out for integration with modular systems
- USB type B connector for use with DAWs and the PolyBrute Connect
- Headphone jack with independent level control

That’s a huge list, and it adds up to a HUGE sound. We can hardly wait for you to get your hands on this instrument! Prepare for your creativity to be set ablaze by PolyBrute.

One more thing: Be sure to visit our website ([www.arturia.com](http://www.arturia.com)) to grab the latest firmware, download the PolyBrute Connect, and check out the tutorials and FAQs.

Musically yours,

**The Arturia team**

# Table Of Contents

1. Overview.....	6
1.1. Front panel.....	6
1.1.1. Left side.....	6
1.1.2. Right side.....	7
1.1.3. The Matrix panel.....	7
1.2. Rear panel.....	8
1.2.1. Connections.....	9
1.3. About this manual.....	9
2. PolyBrute Basics.....	10
2.1. User interface.....	10
2.2. Master controls.....	10
2.3. Auto-calibrate PolyBrute.....	11
2.4. What is digitally-controlled analog?.....	11
2.5. Load a preset.....	12
2.6. Try this!.....	12
2.6.1. Sweep the filters.....	12
2.6.2. Start the arpeggiator.....	12
2.6.3. Move Morph from A to B.....	13
3. Create a Patch.....	14
3.1. Subtractive synthesis.....	14
3.2. Create a new patch.....	15
3.2.1. Initialize the patch.....	15
3.2.2. VCO 1.....	16
3.2.3. VCF 1 (Steiner).....	18
3.2.4. VCA ENV.....	19
3.2.5. Enter the Matrix.....	20
3.2.6. Add Effects.....	21
3.3. Save the patch.....	21
3.4. That was only sound A.....	21
4. Voice Architecture.....	22
4.1. A note about tuning.....	22
4.2. Morph basics.....	22
4.3. VCOs 1 and 2.....	23
4.3.1. Similar features.....	23
4.3.2. VCO 1.....	24
4.3.3. VCO 2.....	25
4.3.4. Noise generator.....	26
4.4. Mixer.....	26
4.5. LFOs.....	27
4.5.1. LFOs 1 and 2.....	27
4.5.2. LFO 3.....	28
4.5.3. Unipolar, bipolar.....	28
4.5.4. LFO sync division.....	29
4.5.5. Rate control for synced LFOs.....	29
4.6. Filters.....	29
4.6.1. Shared features.....	30
4.6.2. VCF 1 (Steiner).....	31
4.6.3. VCF 2 (Ladder).....	32
4.7. Filter FM.....	32
4.7.1. VCO 2 > VCF 1.....	32
4.7.2. Noise > VCF 2.....	32
4.8. Envelopes.....	33
4.8.1. Envelope curves.....	34
4.8.2. VCF/VCA velocity modes.....	34
4.8.3. Envelope loop modes.....	34
4.8.4. Envelope Retriggering.....	34
4.9. Stereo spread.....	35
4.10. FX routing selector.....	35
5. Performance Controls.....	36
5.1. Wheels.....	36



5.1.1. Pitch.....	36
5.1.2. The Wheel.....	36
5.2. Octave buttons.....	37
5.3. Morphée.....	37
5.4. Voice/control mode buttons.....	38
5.4.1. Polyphony.....	38
5.4.2. Timbrality.....	39
5.4.3. Chord memory.....	40
5.4.4. Wheel modes.....	40
5.4.5. Morphée modes.....	41
5.5. Glide.....	41
5.5.1. Glide in Split mode.....	41
5.6. Morph knob.....	42
5.7. Ribbon controller.....	42
5.8. Aftertouch.....	42
5.8.1. Duophonic Aftertouch.....	42
5.9. Expression pedals.....	42
5.10. Motion recorder.....	43
5.10.1. The Stretch factor.....	43
5.10.2. Exceptions.....	43
5.11. Voice allocation modes.....	44
5.11.1. Polyphonic allocation.....	44
5.11.2. Unison / mono allocation.....	45
6. Working with Presets.....	46
6.1. Selecting a preset.....	46
6.2. Snapshots.....	46
6.3. Random patch generation.....	47
6.4. Panel mode.....	47
6.5. Saving a preset.....	47
6.5.1. Quick Save.....	47
6.5.2. Save to another location.....	48
6.5.3. Use PolyBrute Connect.....	48
7. Working with Mods.....	49
7.1. Creating a mod route.....	49
7.1.1. Select the source.....	49
7.1.2. Assign a destination.....	49
7.1.3. Edit an existing modulation.....	51
7.1.4. Modulate a mod route.....	51
7.1.5. Erase all mod routes.....	52
7.2. Mod source list.....	52
7.2.1. What is the Voices source?.....	53
8. Sequencer Mode.....	54
8.1. Common features.....	54
8.1.1. The Home page.....	55
8.1.2. Hold mode.....	55
8.1.3. Metronome.....	55
8.1.4. Time divisions.....	55
8.1.5. Swing percent.....	55
8.1.6. Rate.....	55
8.1.7. Gate.....	55
8.1.8. The transport.....	56
8.1.9. Tap.....	56
8.2. The Arpeggiator.....	56
8.2.1. ARP home page.....	56
8.2.2. Play Mode: Arp.....	57
8.3. The Sequencer.....	57
8.3.1. Sequence playback.....	58
8.3.2. Live edits.....	59
8.3.3. SEQ home page.....	61
8.3.4. Play Mode: Seq.....	62
8.3.5. Sequence length.....	62
8.3.6. Real-time recording.....	63

8.3.7. Step recording .....	63
8.3.8. The Modulation tracks .....	64
<b>8.4. Matrix Arpeggiator .....</b>	<b>64</b>
8.4.1. Matrix Arp home page .....	65
8.4.2. Polyphonic arpeggios .....	66
8.4.3. Approach notes .....	66
8.4.4. Play Mode: Matrix Arp .....	66
<b>8.5. Sequence Management .....</b>	<b>67</b>
8.5.1. Copy current sequence .....	67
8.5.2. Paste sequence .....	67
8.5.3. Paste sequence and automation .....	67
8.5.4. Clear current sequence .....	67
8.5.5. Erase notes .....	67
8.5.6. Erase automation .....	67
8.5.7. Transpose sequence .....	67
<b>9. Step Record / Edit .....</b>	<b>68</b>
9.1. What's the difference? .....	68
9.2. Overdub ON vs. Overdub OFF .....	68
9.3. Step Record .....	68
9.3.1. Enter / edit one step .....	69
9.3.2. Enter / edit many steps .....	69
9.4. Step edit: Notes .....	70
9.4.1. Add / delete notes .....	70
9.4.2. Change the duration .....	71
9.4.3. Select a purple step .....	71
9.4.4. Exit step edit .....	71
9.5. Step record: Mods .....	71
9.5.1. Enter / edit one mod step .....	72
9.5.2. Enter / edit many mods .....	72
9.5.3. Delete a Modulation track .....	72
<b>10. Morph Mode .....</b>	<b>73</b>
10.1. What is Morph Mode? .....	73
10.1.1. Morph vs. crossfade .....	73
10.2. The Morph knob .....	74
10.3. Morphing with Morphée .....	74
10.4. Morph and mod routes .....	75
10.5. Morphing sounds .....	75
10.5.1. Editing sounds A and B .....	75
10.5.2. Morph utilities .....	77
10.6. What can morph? .....	78
10.6.1. Mixer destinations (filter routing) .....	78
10.6.2. LFO 1 / LFO 2 waveforms .....	79
10.6.3. LFO 1-3 Retrigger modes .....	79
10.6.4. LFO 1-3 Sync .....	79
10.6.5. LFO 3 Single .....	80
10.6.6. LFO 3 XLFO 1 .....	80
<b>11. The Effects .....</b>	<b>81</b>
11.1. FX routing .....	81
11.1.1. Mod FX Insert Routing .....	81
11.1.2. Mod FX Send Routing .....	81
11.2. Modulation Effects .....	82
11.3. Distortion Effects .....	82
11.4. EQ .....	82
11.5. Delay .....	83
11.5.1. Delay controls .....	83
11.5.2. Delay sync options .....	83
11.5.3. Delay filter options .....	84
11.6. Reverb .....	84
11.6.1. Reverb filter options .....	84
11.7. Effects preset shortcut .....	84
<b>12. Settings .....</b>	<b>85</b>
12.1. Settings overview .....	85

12.1.1. Preset settings .....	85
12.1.2. Preset > Voice settings .....	85
12.1.3. Global settings .....	86
<b>12.2. Preset&gt;Voice .....</b>	<b>86</b>
12.2.1. Synth Voice>VCO .....	86
12.2.2. Synth Voice>Envelopes .....	90
12.2.3. Synth Voice>LFO .....	91
12.2.4. Synth Voice>Voicing .....	93
<b>12.3. Preset&gt;Out section .....</b>	<b>96</b>
12.3.1. Out>Preset volume .....	96
12.3.2. Out>Stereo modes .....	96
12.3.3. Out>Modulation Settings .....	96
12.3.4. Out>Delay settings .....	97
12.3.5. Out>Reverb Settings .....	98
<b>12.4. Preset&gt;Expression control .....</b>	<b>99</b>
12.4.1. Expression Control>Bend range .....	99
12.4.2. Expression Control>Vibrato Options .....	99
12.4.3. Expression Control>Duo Control .....	100
12.4.4. Expression Control>Morphée Modes .....	101
12.4.5. Expression Control>Ribbon Modes .....	101
12.4.6. Expression Control>Exp1, Exp2 Settings .....	102
12.4.7. Expression Control>Hold .....	102
<b>12.5. Preset&gt;Preset info .....</b>	<b>103</b>
12.5.1. Preset info>Init .....	103
12.5.2. Preset info>Details .....	103
12.5.3. Preset info>Generate .....	103
12.5.4. Preset info>Sound designer .....	103
<b>12.6. Global&gt;Sync .....</b>	<b>104</b>
12.6.1. Sync>Source .....	104
12.6.2. Sync>Clock .....	104
12.6.3. Sync>Metronome .....	104
12.6.4. Sync>Tempo Load .....	105
12.6.5. Sync>Clock Send .....	105
12.6.6. Sync>Transport Send .....	105
<b>12.7. Global&gt;Keyboard .....</b>	<b>106</b>
12.7.1. Curve Options .....	106
12.7.2. Aftertouch Sensitivity .....	107
12.7.3. Aftertouch Filter .....	107
12.7.4. Pedals .....	107
12.7.5. Knob catch .....	108
<b>12.8. Global&gt;MIDI .....</b>	<b>108</b>
12.8.1. MIDI>Channels .....	108
12.8.2. MIDI>Output dest .....	109
12.8.3. MIDI>Input src .....	109
12.8.4. MIDI>Arp/Seq MIDI out .....	109
12.8.5. MIDI>Local control .....	110
12.8.6. MIDI>Program change .....	110
12.8.7. MIDI>Enable CC on Knobs .....	110
<b>12.9. Global&gt;Misc .....</b>	<b>110</b>
12.9.1. Misc>Compare .....	110
12.9.2. Misc>Factory reset .....	110
12.9.3. Misc>Voice auto-tuning .....	110
12.9.4. Misc>Ctrl calibration .....	111
12.9.5. Misc>FW version .....	113
12.9.6. Misc>LED Brightness .....	113
12.9.7. Misc>Sleep Time .....	113
<b>13. Specifications .....</b>	<b>114</b>
13.1. MIDI Continuous Controller assignments .....	115
<b>14. Declaration of Conformity .....</b>	<b>117</b>
14.1. FCC .....	117
14.2. CANADA .....	117
14.3. CE .....	117

14.4. ROHS.....	117
14.5. WEEE.....	118
15. Software License Agreement.....	119

# 1. OVERVIEW

This chapter provides a quick look at the PolyBrute features, front and back. Links are included to many sections for further reading.

## 1.1. Front panel

### 1.1.1. Left side

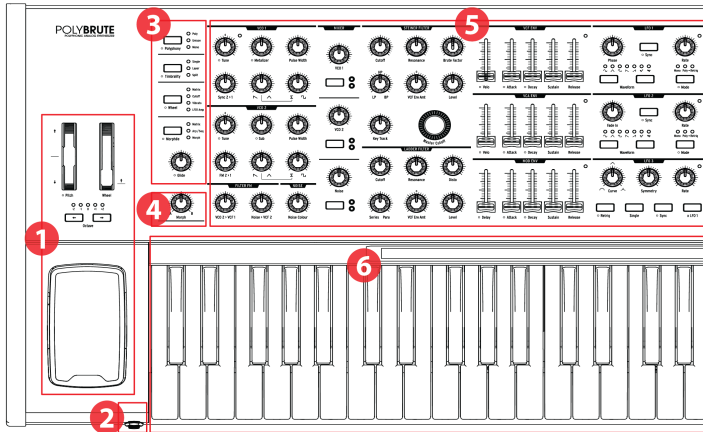

Number	Section	Description
1	Performance controls	<a href="#">Wheels</a> [p.36], <a href="#">Octave buttons</a> [p.37], <a href="#">Morphée</a> [p.37]
2	Headphone jack	Stereo headphone connector
3	<a href="#">Voice management / Control routing</a> [p.38]	<a href="#">Polyphony</a> , <a href="#">Timbrality</a> , <a href="#">Wheel/Morphée routing</a> , <a href="#">Glide</a> [p.41]
4	<a href="#">Morph control knob</a> [p.42]	Adjust balance between sounds A and B
5	<a href="#">Voice parameters</a> [p.22]	VCOs, Filter FM, Noise, Mixer, VCFs, Envelopes, LFOs
6	Keyboard, <a href="#">ribbon controller</a> [p.42]	Keyboard: velocity-sensitive, channel aftertouch Ribbon: route to any parameter via Mod Matrix

## 1.1.2. Right side

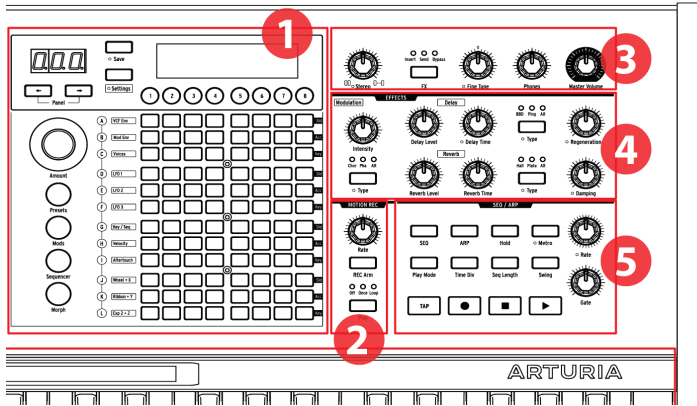

Number	Section	Description
1	Matrix panel	Select presets, Mod Matrix, Seq/Arp, Morph/Matrix editing
2	<a href="#">Motion recorder [p.43]</a>	Capture motion of one control, play back at 1/8x to 8x speeds
3	<a href="#">Master controls [p.10]</a>	<a href="#">Stereo spread [p.35]</a> , <a href="#">FX routing [p.81]</a> , fine tune, phones level, master volume
4	<a href="#">Digital effects [p.81]</a>	Modulation (chorus, phaser, etc.), Delay, Reverb, plus controls
5	<a href="#">Sequencer/Arpeggiator [p.54]</a>	Arpeggiator; real-time/step-time sequencer, step editing, hybrid mode

## 1.1.3. The Matrix panel

The Matrix panel is an 8 x 12 (96-button) grid that has four modes. It is used to select [Presets \[p.46\]](#), to work with the [Sequencer / Arpeggiator \[p.54\]](#), and to manage the modulation matrix through the [Mods \[p.49\]](#) button. The [Morph button \[p.73\]](#) is used to access the modulation matrix with a focus on one or both of the morphing sounds in each patch.

## 1.2. Rear panel

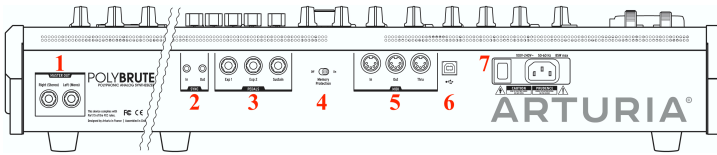

Number	Section	Connections
1	Master Out	Right (Stereo), Left (Mono)
2	Sync	In, Out
3	Pedals	Exp 1, Exp 2, Sustain
4	Memory Protection	Off, On
5	MIDI	In, Out, Thru
6	USB	Type B (max. cable length 3 meters)
7	Power	On/Off switch, AC cable

**1. Master Out** - 1/4" unbalanced +4dBu stereo line-level outputs, intended to go to an amp and speakers, or to an audio interface or mixer. For mono use the left channel only.

**2. Sync In/Out** - These 3.5mm connectors enable the PolyBrute to synchronize with non-MIDI devices through the most widely used sync standards.

**3. Expression 1, 2; Sustain** - Pedal inputs. Expression 1 and 2 work with continuously variable expression pedals to control volume, filter frequency, and more. Sustain is for a momentary on/off pedal (i.e. a sustain pedal). Momentary pedals can be normally closed or normally open; PolyBrute has a polarity setting for each pedal, so you can use either type.

**4. Memory Protection On/Off** - When On, prevents the PolyBrute's patch memories from being overwritten.

**5. MIDI In/Out/Thru** - Standard 5-pin DIN jacks, used to connect PolyBrute to other MIDI devices.

**6. USB** - USB type B port for connecting PolyBrute to a Mac or PC. This lets you use Arturia's PolyBrute Connect software (available from [www.arturia.com](http://www.arturia.com)), and it also exchanges MIDI data with your computer. We recommend using a cable that is no longer than 3 meters (10 feet or shorter).

**7. Power section** - Connect the AC cable to an appropriate power source and use the switch to turn the instrument on and off. Power requirements: 100-240Vac, 50-60Hz, 85W.

## 1.2.1. Connections

### 1.2.1.1. Audio

Connect cables from the Master Out section to a sound system, using the left output for mono if needed. You can also plug headphones into the headphone jack near the Morphée controller; the headphones have their own level control.

### 1.2.1.2. USB

Next, connect the PolyBrute to your computer with a USB cable. Then go to [www.arturia.com](http://www.arturia.com), register your PolyBrute, and download the PolyBrute Connect software.

PolyBrute Connect is much more than a patch librarian; it's a two-way visual editing environment that enables you to see the entire patch at once, which makes the morphing feature even more obvious. It's also used to upgrade the PolyBrute firmware.

But even more than that, PolyBrute Connect can be used as a VST plug-in inside a DAW, which in turn can record the movements of the controls inside the Software or on the PolyBrute itself. As long as the PolyBrute is connected to the computer, whenever the DAW track plays back it will be almost like using the PolyBrute as a plug-in synthesizer. You'll still need to set up an audio track in the DAW to record the output of the PolyBrute, if you want those tracks to reside inside the computer.

### 1.2.1.3. MIDI

Almost everything you can touch on the PolyBrute sends and responds to MIDI, which makes it possible to capture and refine whatever happens in pursuit of a sound or a song. This can happen over USB, the 5-pin DIN connectors, or both.

For a list of the MIDI CC numbers sent and received by each control, see the [Specifications chapter \[p.115\]](#).

## 1.3. About this manual

We want this manual to be easy to read, so whenever possible we've done the following:

- The names of buttons and knobs are in brackets. "Hold [Settings] and turn [Glide]" is quicker to read than "Hold the Settings button and turn the Glide knob."
- Characters are often used; e.g., [Octave < / >] instead of "the Octave left and right buttons."
- Navigation is shown in pathways: "Settings/Misc/Voice Auto-Tuning/1-4" means "Press [Settings], select Misc (Assign button 8), select Voice Auto-Tuning (Assign button 4), and select option 1, 2, 3, or 4."
- Some sections point to others by page number so you can learn more if you want, without slogging through a bunch of text when you already know the details.
- The terms "preset" and "patch" are used interchangeably to refer to a single memory location.



## 2. POLYBRUTE BASICS

### 2.1. User interface

Here are some general notes about working with PolyBrute. For example:

- Press [Settings] to access the Preset/Global option menus.
- The display lists options by numbers that correspond to the eight buttons under the display.
- The numbered buttons (i.e., Assign buttons) usually select menu items, though in Mods mode they do more.
- When inside a menu, use [Settings] to return to the previous menu or page.
- An orange dot by a control means "shortcut": Hold [Settings] and activate the control to access its menu.
- The menu for a button with an orange "shortcut" dot can be accessed with a long press of that button.
- Lit LEDs indicate a selection, status, or routing.
- Flashing LEDs show a rate or a triggered event, with only one exception (the Split LED, described later).
- The 96 Matrix buttons select Presets, indicate and select Mod routes, or show the current sequencer step, depending on the active mode.

You know the rest (knobs, sliders, buttons, etc.). Hopefully this manual will explain anything that doesn't explain itself.

### 2.2. Master controls

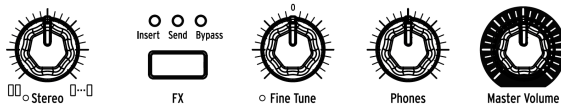

The settings of these controls are stored with the preset:

- **Stereo spread:** Adjusts the stereo width of the output signal. This can be modulated via the Mod Matrix.
- **FX:** Handles the routing of the Effects section. Follow [this link \[p.35\]](#) to learn more.

The following controls are *not* stored with the preset:

- **Master Volume:** The synthesizer itself will not distort with the level all the way up; the control is only to avoid overloading the next step in the chain (mixer, audio interface, amp...).
- **Phones:** The headphone level is independent of the Master Volume.
- **Fine Tune:** - Global tuning  $\pm 1$  semitone from the knob's center detent.

## 2.3. Auto-calibrate PolyBrute

One thing to remember about analog synths is that many components are temperature-sensitive, which can lead to small variations in pitch and timbre over time. It's part of what makes them seem "alive." We recommend that you let the circuits stabilize for 5-10 minutes after power-up. If the tuning still seems a bit loose after that, you can run one of the calibration routines as described below.

There are three types of auto-calibration, and you can run one by itself or run them all. Here's how:

1. Press [Settings].
2. Select Misc (Assign button 8).
3. Select Voice Auto-Tuning (Assign button 4).
4. Now select button 1, 2, or 3 depending on the desired tuning target.

Here's what the options mean:

- **VCO Calibration** tunes both oscillators for each voice. You may want to run this one more often than the others.
- **VCF Calibration** tunes both filters for each voice. It also makes sure the filters track the keyboard well.
- **All** runs the calibration routines automatically, one after the other. This will also calibrate the VCAs.
- **Restore** resets the PolyBrute to the calibration values measured at the factory.

It takes a while to run the calibration routines, which is why we made it possible to launch them individually as needed.

## 2.4. What is digitally-controlled analog?

Unlike early synthesizers, PolyBrute has the advantage of digital control over its analog circuitry. It's the best of both worlds: the warmth and hands-on control of real analog, with the ability to save and recall patches and settings (not to mention USB, MIDI, and other modern features).

For this reason, when you load a patch the physical positions of the knobs and sliders may not match the parameter values stored with the patch. But the PolyBrute has three modes that allow you to specify how these controls respond when they are first moved. These settings are available in the software and at Settings / Misc / Knob Catch.

- **Hook** - a control must sweep past the stored value before it changes the parameter. Benefit: smooth changes.
- **Jump** - the value jumps to the position of the control as soon as you move it. Benefit: instant response.
- **Scaled** - the parameter changes from its stored value when the control moves, and the range is scaled (averaged) to cover the remaining values in that direction. When the control direction is reversed the normal parameter range is restored. Benefit: instant response *and* smooth changes. This is the default setting.

It's always possible to audition the settings of the front panel. This process is described in the [Panel mode section \[p.47\]](#).

## 2.5. Load a preset

To start exploring the presets, press the large Presets button. It turns purple when selected.

PolyBrute has 8 banks of 96 presets (for a total of 768). Select the banks with Assign buttons 1-8, then select the presets inside the bank using the 12 rows of 8 buttons in the Matrix panel.

To load patch B3 in bank 1, for example, press the round "1" button under the display (if you're not already in bank 1). Then find the third button from the left in row B and press it. The Program display shows "1.B3": "1" is the bank, "B" is the row, and "3" is the column.

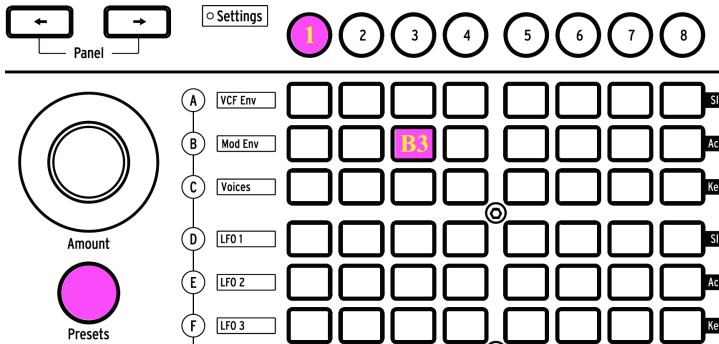

*Bank 1, preset B3 selected*

[Program < or >] also can be used to select adjacent patches.

## 2.6. Try this!

The Morphée controller, the Ribbon, and the pitch/mod wheels probably caught your eyes already. They're a ton of fun and provide unique tools for musical expression. As you're auditioning presets, be sure to try these features too:

### 2.6.1. Sweep the filters

The Master Cutoff knob sweeps both filters at the same time. Some presets might not use both filters, so this is a guaranteed way to get a reaction out of one or both of them. For full details, see the [Filters section \[p.29\]](#).

### 2.6.2. Start the arpeggiator

For instant musical gratification it's hard to beat an arpeggiator. If the selected preset doesn't play something automatically when you touch a key, here's what to do:

- If the patch has a slow attack, adjust the Attack sliders for VCA ENV and VCF ENV (or select another preset)
- Press the ARP button and hold down a few keys. If nothing happens, make sure Settings/Sync is set to Auto.
- For hands-free fun, activate the Hold button. Then you can tweak the controls while PolyBrute keeps playing.

- Try other Arp settings (Play Mode, Time Div, Swing, and Gate). There's a lot of variability right there.

When you're done, press the Stop button. There's more information about the entire Seq/Arp section [here \[p.54\]](#).

### **2.6.3. Move Morph from A to B**

Part of the reason PolyBrute sounds amazing is because every preset is made up of two parallel sounds (A and B), with constant, complementary modulation going on between the two in most cases. So whatever patch you've selected, be sure to turn the Morph knob to check out its component sounds.

Then try this: Turn the Morph knob to position B, do an extreme edit, then turn back and forth between A and B. When the Morph knob is on A you won't hear your edit; when it's on B that's all you'll hear. If the Morph knob is in the middle between A and B, any edits you make will be performed equally on sound A *and* sound B.

Hopefully we've covered enough topics to get you started exploring PolyBrute on your own. Now have some fun!

## 3. CREATE A PATCH

This chapter walks through the basics of sound design on the PolyBrute, starting with an initialized patch, shaping it, and finally saving it. Advanced users can jump to areas of interest by following the links in each section.

### 3.1. Subtractive synthesis

PolyBrute is an analog subtractive synthesizer. This method of synthesis starts by generating raw waveforms, and then uses filters to remove (subtract) unwanted harmonics to achieve the desired sound.

However, PolyBrute also has the Metalizer, Sync and FM functions in the oscillator section which can add harmonics to the basic oscillator sound. The results then can be sculpted further with the filters.

The basic signal flow is simple, and generally follows this order:

- [VCO \(voltage-controlled oscillators\) \[p.23\]](#) generate the waveforms and control the pitch frequency
- [VCF \(voltage-controlled filters\) \[p.29\]](#) shape the harmonic content
- Envelopes, LFOs, and other sources are used to alter (modulate) parameters. Modulators can even control other modulators.

Speaking of which, one of the main features of the PolyBrute is its Matrix. This is an internal patchbay that can route any modulation source to one or more destinations. Some sources are physical, such as the Morphée controller; others are internal, such as an LFO, and can run freely or synchronize to the master clock (internal or external). The impact on the sound can be as subtle or extreme as you like.

Finally the signal passes through the amplifier section, takes a detour into the effects section (if desired), and then the output level is set by the Master Volume control.

This manual covers all of those features in depth. For now we'll start by building a basic patch.

## 3.2. Create a new patch

The following example uses VCO 1, VCF 1, LFO 1, and an envelope. PolyBrute has two or three of each, but let's keep it simple for now.

### 3.2.1. Initialize the patch

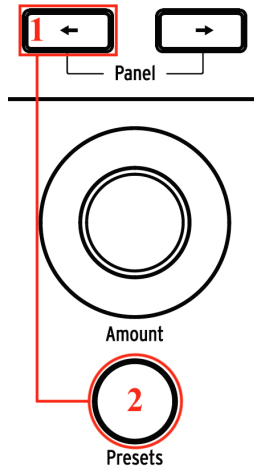

To create a preset from the ground up, begin by initializing the patch. This creates a simple sound with no modulation routings that you can use to create an original patch. There are two ways to do this:

- Hold the Program left arrow and press [Presets], or
- Navigate to Settings/Preset Info and select Init with Assign button 1.



ⓘ: Initializing a patch only affects the edit buffer. It doesn't erase the patch where you started, unless you decide to save your new patch on top of the old one.

### 3.2.2. VCO 1

After the patch has been initialized, play a note on the keyboard. You'll hear a simple, bright waveform from VCO 1 only.



In the Mixer section, press the VCO 1 Filter button repeatedly until the LED inside the orange circle is lit. The filter sections are color-coded to match the circles, so this means that VCO 1 is routed to the Steiner filter.

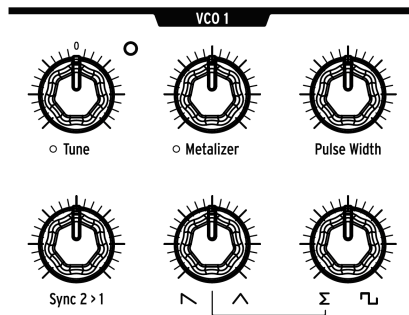

Adjust the VCO 1 Tune knob up, down, and back to center. This is how to set its basic pitch.

### 3.2.2.1. VCO 1 waveform mix

PolyBrute VCOs constantly generate three basic waveforms (sawtooth, triangle, and square), with two knobs on the bottom row of the VCO module for adjusting the mix between them. To observe this:

1. Turn the second and third knobs counter-clockwise so they point to the sawtooth and the sigma ( $\Sigma$ ), respectively.
2. Hold a note and turn the second knob through its full range: 100% left = sawtooth; 100% right = triangle. A middle position provides a blend of both.
3. For now, leave this knob at 100% right so all you hear is the triangle wave. This makes it easier to hear what the third knob does.
4. Sigma ( $\Sigma$ ) is a math symbol that means "the sum of." When the third knob points there, that means all you hear is the sum of the output from the second knob (i.e., the mix between the saw and triangle waves).
5. Turn the third knob gradually to the right. The square wave begins to be heard.
6. When the third knob is 100% right, only the square wave is heard. To prove this, move the Saw/Triangle wave knob through its full range. You should hear no change to the sound.
7. Turn the Sigma/Square wave knob to the 12:00 position and move the Saw/Triangle wave knob to experiment with the blend between all three waveforms.

### 3.2.2.2. Shape the VCO 1 waveform

Each waveform mix knob has a related shaper/enhancer in the top row. First some definitions:

- **Metalizer** adds intense harmonics to the triangle waveform through a process known as *wavefolding*.
- **Pulse Width** changes the sound of the square wave from "round" to increasingly narrow.

Turn the second bottom-row knob to 100% right (triangle), the third knob to 100% left ( $\Sigma$ ), and we'll learn about the top-row knobs.

1. Play a note and slowly turn Metalizer from minimum to maximum. The sound becomes more "edgy."
2. Turn Metalizer down to zero and turn the third bottom-row knob from  $\Sigma$  to the square wave.
3. Turn Pulse Width to 100% left. This is the pure square wave.
4. Play a note and slowly turn Pulse Width from minimum to maximum. The sound becomes thinner as the pulse width narrows. At 100% right the pulse wave is so thin it is barely audible.



♪ The Metalizer can also affect all waveforms, not just the triangle, if its mode is set to "Level (All waves)" in the PolyBrute's settings. See the [Metalizer mode \[p.88\]](#) entry in Chapter 12 for details.

Now return those four knobs to 100% left (pure sawtooth wave) and let's explore the Steiner filter.



### 3.2.3. VCF 1 [Steiner]

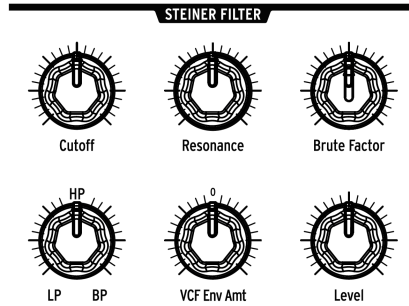

The Steiner filter defaults to lowpass mode in the Init patch, which means that anything below the corner frequency is allowed to pass; anything above it is gradually filtered out.

1. Sweep the Cutoff knob through its full range while holding a note. There's no sound when the knob is all the way down because the lowpass filter is blocking all frequencies from passing.
2. Move the Resonance knob halfway up and sweep the filter again. Resonance emphasizes the corner frequency of the filter.
3. Turn the Filter type knob to HP (halfway up) and sweep the filter again. Notice how the frequencies disappear from the bottom up, and at the maximum cutoff value there is no sound. HP (highpass) is the opposite of LP (lowpass): HP allows high frequencies to pass and filters out the lower frequencies.
4. Turn the Filter type knob to BP (100% right) and sweep the filter again. BP (bandpass) allows a center band of frequencies to pass and filters out the higher and lower frequencies. Resonance emphasizes the corner frequencies. As the filter sweeps through its range, the center band moves up and down through the audio spectrum.
5. Set the Filter type knob halfway between LP and HP. This turns VCF 1 into a "Notch filter", which is the opposite of bandpass: the LP and HP filters work together to *remove* frequencies in the middle. Resonance emphasizes the corner frequencies. As the filter sweeps through its range, the notch moves up and down through the audio spectrum.
6. Now try the Filter type knob at other positions. For example, halfway between HP and BP provides a 50/50 mix of both types.



**i** The Master Cutoff knob can be used for the above example instead. But it actually controls both filters at the same time, which may not always be what you want.

#### 3.2.3.1. About the other knobs...

For this overview we've only used half of the knobs in the VCF 1 module (Cutoff, Resonance, and Filter type). Here's a quick description of the other controls, with details in the [Filters section \[p.29\]](#) of the [Voice Architecture chapter \[p.22\]](#).

- **Brute Factor** adds distortion by feeding the filter output back into itself. This can be subtle or wild. Try with various VCO 1 mixer levels.
- **VCF ENV Amt** routes VCF 1 through VCF ENV. Lower the Cutoff to make headroom for the envelope.
- **Level** controls the output level of VCF 1. Results are most obvious when the Series/Para knob is 50-100% to the left.

The sound has a basic tone now, but it needs more of a *shape*. That's what envelopes do, so we'll cover that next.

### 3.2.4. VCA ENV

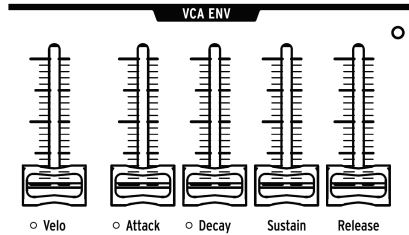

PolyBrute has three envelopes. We'll use the VCA ENV to learn what envelopes do, and describe the other two later.

The VCA (voltage-controlled amplifier) is the final output stage prior to the Effects. VCA ENV is used to shape the amplitude of the VCA. It's a 4-stage envelope (Attack/Decay/Sustain/Release, or ADSR). Here's what each stage does:

- **Attack** sets the time it takes the envelope to reach its full level.
- **Decay** determines how long it takes the envelope to reach the Sustain level.
- **Sustain** is the target level for the Decay. The envelope decays until it reaches this level, unless the key is released before it gets there.
- **Release** determines how long it takes the envelope to fade out after the key is released.

These steps show the function of each stage. If needed, initialize the sound [as described here \[p.15\]](#).

1. Adjust the VCA ENV Attack slider while playing the keyboard. Higher values mean slower attack times. Use a fast attack for now.
2. Move the Decay fader up and down. The initialized sound won't change, because the Sustain level is at maximum by default. The envelope can't decay because it has nowhere to go.
3. Set the Sustain level to 1/4 of the way up, and try the Decay fader again. It governs the amount of time it takes to settle from the Attack level to the Sustain level.
4. With Decay and Sustain 1/4 of the way up, play some notes while moving the Release fader. This controls how long it takes for the envelope to return to zero after a note is released.
5. The Velo fader adjusts the way the envelope responds to note velocity. With the fader all the way down the envelope has no dynamic range. When it is at maximum, playing the keys with varying degrees of force results in notes that are proportionately softer and louder.

The other two envelopes are described in [this section \[p.33\]](#). But here's a quick summary:

- The VCF ENV can shape the harmonic content of both filters. It has the same controls as the VCA ENV, so it can affect timbre the same way VCA ENV affects amplitude. Note that VCF ENV Amt interacts with Cutoff to provide headroom for the VCF ENV to work.
- The MOD ENV is a 5-stage envelope with a Delay stage prior to the Attack stage (DADSR). It only affects the patch when used as a modulation source in the [Mod Matrix \[p.49\]](#).

### 3.2.5. Enter the Matrix

The true power of PolyBrute lies in how its parameters interact. For a glimpse of this we'll set up a couple of modulation routes in the Matrix. But first an overview of the Mod Matrix:

- It holds 32 mod routes arranged in 4 pages of 8 destinations each
- Up to 64 connections can be made within those 32 routes
- Sources are clearly labeled (rows A-L)
- Easy destination assignment: hold an Assign button under the display, move a knob or fader
- Quick connections: press the Matrix button where the source and destination intersect
- Simple mod edits: select a route, turn the Amount knob in either direction

#### 3.2.5.1. Add LFO to VCO pitch

1. Starting with an [initialized patch \[p.15\]](#), press the large Mods button.
2. To connect LFO 1 to VCO pitch (Pitch Global), press Matrix button D1. The button turns purple to indicate the connection, and a pop-up window shows "Amount: 0 semitones".
3. Hold a note and turn the Amount knob in either direction. Pitch modulation is heard.
4. Turn the LFO 1 Rate knob to change the modulation speed, etc.
5. To break the mod connection, press button D1 again. A dark button means there is no connection.
6. Press D1 again to reconnect the route, then press any other Matrix button. D1 turns blue to indicate an active mod route, and the purple button indicates the current selection.

#### 3.2.5.2. Aftertouch control of VCF 2 cutoff

1. Starting with an [initialized patch \[p.15\]](#), press the large Mods button.
2. To assign the VCF 2 cutoff as mod destination 4, hold Assign button 4 and turn the Ladder Cutoff knob.
3. To connect Aftertouch to VCF 2 cutoff, press Matrix button I4. The button turns purple to indicate the connection, and a pop-up window shows "Amount: 0%".
4. Use the Amount knob to select a value of -100%.
5. Play a key and slowly increase the pressure on the key. The VCF 2 cutoff frequency decreases as pressure increases.

We've barely scratched the surface! There's an entire chapter dedicated to the [Mod Matrix \[p.49\]](#). But a great way to learn more is to peek inside your favorite patches and see how the modulation routes were used.

### 3.2.6. Add Effects

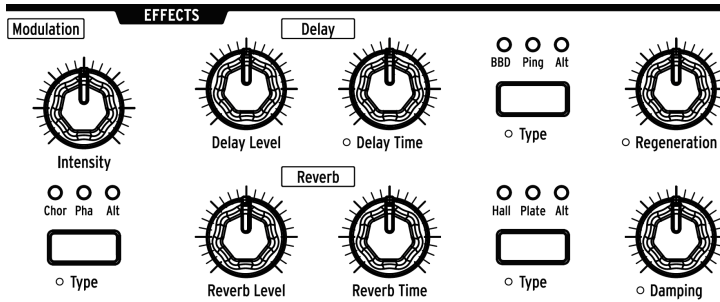

The [Effects section \[p.81\]](#) can add motion and ambience to any patch. Even the initialized patch can sound great! Simply raise the Modulation Intensity knob to add some chorus, raise the Delay and Reverb levels to suit your tastes, and enjoy.

### 3.3. Save the patch

If you want to keep your new patch, there are several methods described [here \[p.47\]](#). But if you already know of an available preset location, hold **Save** and select that location with the Matrix buttons. Instructions for naming the patch are [here \[p.48\]](#).

### 3.4. That was only sound A...

As mentioned earlier, every preset is made up of two parallel sounds (A and B). The Morph knob of an initialized preset points to sound A by default. If you're ready, turn the Morph knob to B, go back to [create a new patch \[p.15\]](#), and do it all again for sound B using different values. Then set the Morph knob to the optimal position between A and B and save the revised patch. The position of the Morph knob is stored with the patch.

## 4. VOICE ARCHITECTURE

The PolyBrute has two types of sound sources: voltage-controlled oscillators (VCOs) and a noise generator. Their levels are set by the Mixer, then they pass through one or both filters before heading to the voltage-controlled amplifier (VCA). Each of those items can be modulated by multiple sources, thanks to the Mod Matrix. It all adds up to the best set of sound sculpting tools a synthesist could want.



♪ The small orange circles near many of the knobs, sliders, and buttons mean there's a shortcut to the underlying settings of those parameters. Hold [Settings] and activate that control, or hold one of those buttons for about 1 second, and you'll be taken to a related page.

### 4.1. A note about tuning

Analog components tend to drift a bit, so you may need to auto-tune PolyBrute occasionally. This helps to ensure per-voice consistency of pitch, keyboard tracking, envelope response, etc.

We recommend that you let the circuits stabilize for 5-10 minutes after power-up. After that, if it seems the VCO tuning or filter tracking could be tighter, you can run one or more of the calibration routines. Navigate to Settings > Misc > Voice Auto-Tuning and then select options 1-3, depending on the desired target.

### 4.2. Morph basics

The morphing aspect of the PolyBrute is an essential part of its voice architecture. In a nutshell, every patch is made up of two sounds (A and B), and PolyBrute can morph seamlessly between them. The sonic metamorphoses can be subtle or profound.

Almost every section of this chapter applies equally to sounds A and B. Once you are comfortable with the basics, try editing the patch with the Morph knob set all the way to sound A, all the way to sound B, and in various positions between the two until the patch is perfect.

For an in-depth look and the morphing features, see the [Morph Mode chapter \[p.73\]](#).

## 4.3. VCOs 1 and 2

The VCOs have some similar features that we'll cover here. VCO-specific features are described in the sections that follow.

### 4.3.1. Similar features

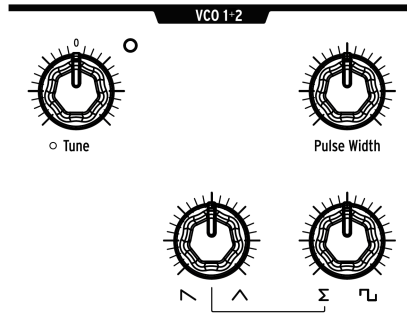

*Both VCOs have these parameters.*

#### 4.3.1.1. Tune

Each VCO has a Tune knob, but they can respond differently for each preset.

- The VCO 1 Tune knob range is  $\pm 2$  octaves, and its LED lights when set to an octave increment ( $\pm 2$ ,  $\pm 1$ , or center). The knob tuning changes chromatically, but when "Pitch Vco1" is a mod route destination it can change smoothly, chromatically, or according to a scale.
- The VCO 2 Tune knob has a variable range, and also several ways it can be modulated through the Mod Matrix.

Hold [Settings] and move one of those controls to access their parameters. They are also found at Settings/Synth Voice/VCO.

#### 4.3.1.2. Pulse Width

Pulse Width adjusts the distance between the rising and falling edges of a square wave. When the distances are equal, that's a pure square wave; it sounds a bit like a clarinet. When the distances are not equal, the square wave sounds increasingly thin. At the maximum setting the square wave disappears, and so does the sound.

#### 4.3.1.3. Mixable waveforms

The VCOs constantly generate three basic waveforms (sawtooth, triangle, and square), with two knobs on the bottom row of the VCO module for adjusting the mix between them. For a detailed explanation, see [VCO 1 waveform mix \[p.17\]](#). It applies equally to both VCOs.

### 4.3.2. VCO 1

VCO 1 has two controls that VCO 2 does not:

#### 4.3.2.1. Metalizer

What is waveshaping? Imagine the peak of a triangle folding over in the middle: now two sharp peaks are visible on either side. Then picture *those* peaks folding over, and so on. That's what the Metalizer does to a triangle wave; it becomes more "jagged," which increases the harmonic content.

But a waveform is bipolar, so actually the top peaks fold downward and the "bottom peaks" fold upward, as in this image.

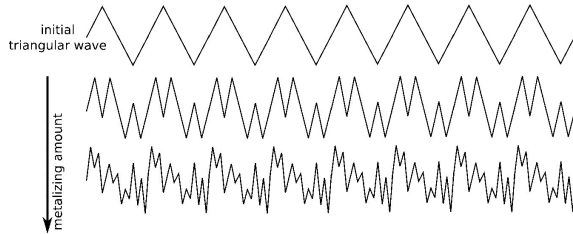

**i** The Metalizer can also affect all waveforms, not just the triangle, if its mode is set to "Level (All waves)" in the PolyBrute's settings. See the [Metalizer mode \[p.88\]](#) entry in Chapter 12 for details.

#### 4.3.2.2. Sync 2 > 1

Oscillator sync is a popular feature on analog synthesizers. Normally it takes two forms (hard sync or soft sync), and the two oscillators are either synced or they aren't. But the way PolyBrute does this is unusual: its oscillator sync is continuously variable from off to hard sync, progressing through many levels of soft sync on the way.

Increasing the value of Sync 2 > 1 progressively locks the pitch of VCO 1 to VCO 2. At the maximum setting, turning the VCO 1 Tune knob doesn't change the pitch of VCO 1; instead it sweeps through a series of synced harmonics.

### 4.3.3. VCO 2

VCO 2 is very influential: it can force VCO 1 to sync its harmonics (Sync 2 > 1 above), modulate its fundamental frequency (FM 2 > 1 [p.25]), modulate VCF 1 (VCO 2 > VCF 1 [p.32]), and appear directly in the mixer, all at the same time. Plus it has a descendant: a sub-oscillator, described in the next section.

VCO 2 has two controls that VCO 1 does not:

#### 4.3.3.1. Sub

The sub-oscillator produces a sine wave that is always an octave below the fundamental pitch of VCO 2. It is not shaped by the VCO 2 waveform mix (saw, triangle, square), but when added to the output of VCO 2 it can modulate VCO 1 and VCF 1 (through Sync 2 > 1 and VCO 2 > VCF1, respectively).

The Sub knob adjusts the VCO 2 mix between no sub-oscillator (full left), equal parts fundamental and sub-oscillator (halfway up), and sub-oscillator only (full right). The following pictures illustrate the effect the sub-oscillator has on a pure sawtooth wave from VCO 2:

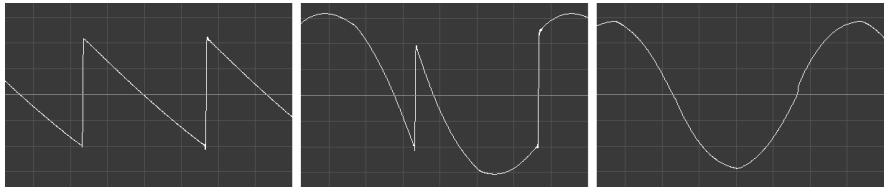

*Sub-oscillator level = 0%*

*Sub-oscillator level = 50%*

*Sub-oscillator level = 100%*

Note that the energy output of VCO 2 is greater when the sub-oscillator mix is at 50%, since both sources are present.

#### 4.3.3.2. FM 2 > 1

FM (Frequency Modulation) is when the frequency of one oscillator is used to modulate the frequency of another. The FM 2 > 1 control lets VCO 2 do this to VCO 1. The result is very different than simply mixing the two oscillators together. In fact, you can hear this effect even if the Mixer level for VCO 2 is zero.

For example, try this:

1. Set both VCO waveforms to Triangle and turn up both in the Mixer so you can tune VCO 2.
2. Play a note and turn VCO 2 all the way down in the Mixer.
3. Now gradually raise the FM 2 > 1 level. The tone becomes increasingly complex, even though you're only hearing VCO 1. This is the effect VCO 2 is having upon VCO 1. This effect will also be modified if you change the VCO 2 pitch or waveform mix.



A high FM 2 > 1 value can heavily affect the pitch. But using it in combination with a high Sync 2 > 1 value can provide steady pitched tones with complex harmonic content.



### 4.3.4. Noise generator

A noise generator produces a random series of frequencies and amplitudes. With no fundamental frequency, there's no specific pitch. Noise Colour changes the character from red noise (dark) to white noise (bright) and every possible shade between the two.

Noise can provide a breathy or percussive element, or it can be used on its own to emulate wind or water sounds, etc. It also can [modulate VCF 2 \[p.32\]](#) when the sound needs a bit of "rasp" or timbral chaos.

### 4.4. Mixer



Use the knobs to set the relative levels of the VCOs and the noise generator. The buttons select the filter routing for each source. When both LEDs are dark, neither filter is selected and the source is muted.

The setting of the Series / Para knob in the Ladder Filter module also affects filter response. Full details are [here \[p.31\]](#), but it's important to know that when that knob is set to 100% left (Series), VCF 1 is routed completely through VCF 2. If the VCF 2 Cutoff is too low you won't hear the output of VCF 1.

## 4.5. LFOs

LFO stands for Low Frequency Oscillator. LFOs generate waveforms in a lower frequency range than VCOs, and are used as modulation sources to affect other parameters. The PolyBrute LFOs can run as slowly as one cycle every 50 seconds all the way up to 100Hz (the audible range). To be "heard" they must be routed to a destination using the [Mod Matrix \[p.49\]](#).

Each LFO has its own features: LFOs 1 and 2 are very similar, and LFO 3 is in a class by itself.

### 4.5.1. LFOs 1 and 2

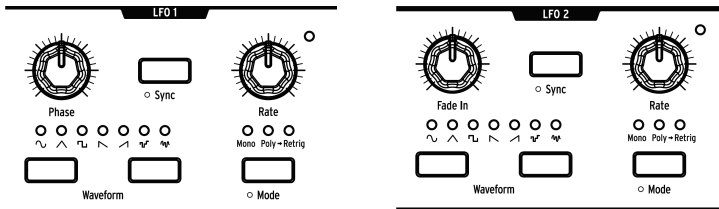

LFOs 1 and 2 are identical except for one knob in each module: Phase (LFO 1) and Fade In (LFO 2). Here's what the controls do:

- **Phase** (LFO 1 only) adjusts where the LFO wave cycle starts relative to the note trigger. Use the leftmost position to start the LFO at the beginning.
- **Fade In** (LFO 2 only) offsets the start of LFO 2 and also fades it in gradually.
- **Sync** locks the LFO to the Seq / Arp tempo ([see Sequencer Mode \[p.54\]](#)), which can be synced to external sources.
- **Rate** sets the LFO frequency. An LED in the right corner of each LFO module flashes to indicate the rate.
- **Waveform** buttons move left and right through the waveforms. An LED shows the current choice.
- **Mode** cycles through three options for the way the LFOs respond to note triggers and retriggers:
  - *Mono* - The LFO oscillates on its own. The wave could be anywhere in its cycle when a note is triggered, and all notes share the same LFO.
  - *Poly* - Each voice has an independent, free-running LFO. If a voice is retriggered, the LFO does not reset.
  - *Poly>Retrig* - Each voice triggers an independent LFO. If the same voice is retriggered, the LFO resets.

 There is also a "hidden" Mono Retrig mode. When the **Mode** button here is set to Mono and the [Global Retrig \[p.91\]](#) for either or both LFOs is activated in *Settings > Voice*, a Mono LFO shared by all voices will retrigger at the beginning of its phase upon each key press.



There are seven waveforms available for LFOs 1 and 2: sine, triangle, square, reverse sawtooth, sawtooth, sample & hold, and slewed random. Their images show what to expect: the square wave jumps instantly from low to high, the triangle ramps up and back down, etc. The differences are most obvious at slower rates.

#### 4.5.2. LFO 3

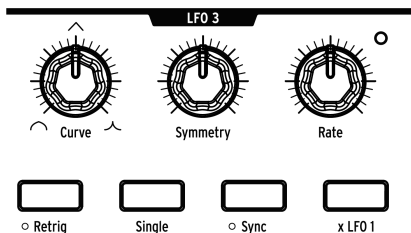

LFO 3 shares some features with LFOs 1 and 2, and has some that are unique and unusual.

- **Curve** changes the LFO shape from logarithmic (100% left) to linear (halfway) to exponential (100% right).
- **Symmetry** alters the ratio between the rising and falling times of the LFO without affecting the rate.
- **Rate** sets the LFO frequency. An LED in the right corner of the LFO module flashes to indicate the rate.
- **Retrig** toggles LFO response between Mono (dark) and Poly>Retrig (lit). See the previous section for descriptions.
- **Single** means the LFO runs through one cycle and stops. LFO3 is unipolar when Single mode is active, and this interacts with [Retrig] in useful ways. With [Retrig] off, LFO3 can be used as a simple attack-decay envelope. With [Retrig] on, LFO3 “freezes” at the end of its rising phase and begins its falling phase only when the key is released, behaving like an attack-hold-release envelope.
- **Sync** locks LFO 3 to the Seq / Arp tempo (see [Sequencer Mode \[p.54\]](#)), which can be synced to external sources.
- **x LFO 1** modulates LFO 3 with the output of LFO 1. For example, if LFO 1 is a square wave, the amplitude of LFO 3 is low while the square wave is low, and its amplitude is high when the square wave is high. This enables LFO 3 to generate some very unusual waveforms. Try various rates and waveforms to see what happens. For the most predictable results, activate the Sync button for both LFOs. When [x LFO 1] and [Single] are active, LFO 1 triggers LFO 3 each time LFO 1 begins its cycle.

#### 4.5.3. Unipolar, bipolar

All three LFOs can operate as unipolar modulation sources or bipolar modulation sources. When set to unipolar the LFOs are rectified, moving from zero to their maximum positive value and back to zero with each cycle. When they are bipolar they move between their positive and negative maximums, crossing zero with each cycle.

To access these settings for LFO 1 or LFO 2, hold [Mode] for 1 second. For LFO 3, hold [Retrig] for 1 second.

#### 4.5.4. LFO sync division

Hold an LFO [Sync] button to reveal the Sync Division menu for that LFO. Each LFO can have its own setting: Binary, Triplet, or Dotted. These take effect when [Sync] is active for an LFO.

#### 4.5.5. Rate control for synced LFOs

When an LFO Sync button is active, moving the LFO Rate knob selects different time divisions for the LFO. The display shows the value as the knob is turned.

### 4.6. Filters

Filters define subtractive synthesis: they remove harmonic content generated by the oscillators. High levels of resonance can drive filters into self-oscillation, so they are potential sound sources. When modulated their timbre varies over time, which adds motion to the sound.

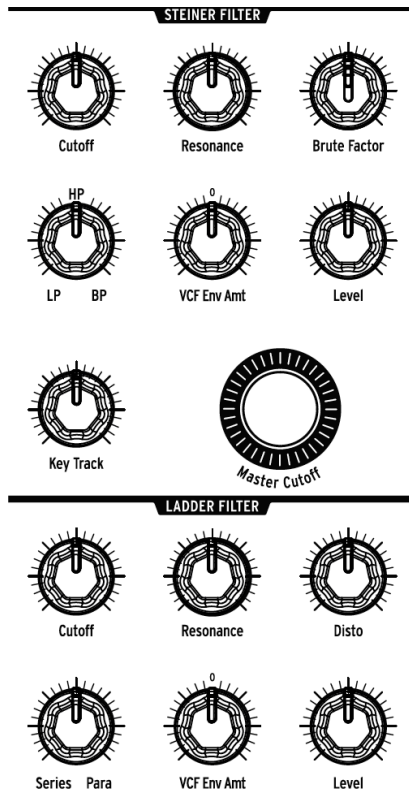

*The PolyBrute filter modules*

PolyBrute features two types of Voltage-Controlled Filters (VCFs): a 12 dB/octave Steiner filter and a 24 dB/octave Ladder filter. Each has its own features which will be described separately, but first let's take a look at what they have in common.

### 4.6.1. Shared features

Both PolyBrute filter modules have the following controls:

- **Cutoff** sets the corner frequency individually for each filter.
- **Resonance** emphasizes the corner frequency. Higher resonance levels can cause a filter to self-oscillate.
- **VCF Env Amt** controls the level of cutoff frequency modulation caused by the VCF ENV. It's a bipolar control, so positive and negative envelopes are possible.
- **Level** adjusts the output of the filter.

#### 4.6.1.1. Master Cutoff

Both filters are affected by the **Master Cutoff** knob, which sweeps the cutoff frequencies of both VCFs at the same time. To reset the Master Cutoff value to 0, hold the Panel left arrow and turn the Master Cutoff knob.

#### 4.6.1.2. Key Track

This determines how much the cutoff frequencies of both filters change based on the key that is played. Values range from no change (100% left) to maximum change (100% right), in which the cutoff frequency increases or decreases relative to the distance of a note from middle E (MiDI note 64). The filters are gradually opened above that note and gradually closed below that note.

### 4.6.1.3. Series / Para

The Series / Para knob is located in the Ladder filter module, but it affects both filters. It achieves the desired balance between running the filters in parallel or in series, where the output of VCF 1 is fed into VCF 2. This is better than "the best of both worlds": this is a blending of two worlds to make the world you want.

In case these terms are unfamiliar, here are two examples of what this means:

- Filters in series use each other's strengths. VCF 1 can cut the lows with its 2-pole HP mode, and then VCF 2 can roll off the highs with its 4-pole LP curve. The result is like one filter with two different slopes. The whole is greater than the sum of the parts, as they say.
- Parallel mode allows stereo synthesis, where the left and right channels can have different evolving sounds. This is an ideal feature to combine with the morphing features of PolyBrute.

Here's a simple diagram of the relationship between the filters.

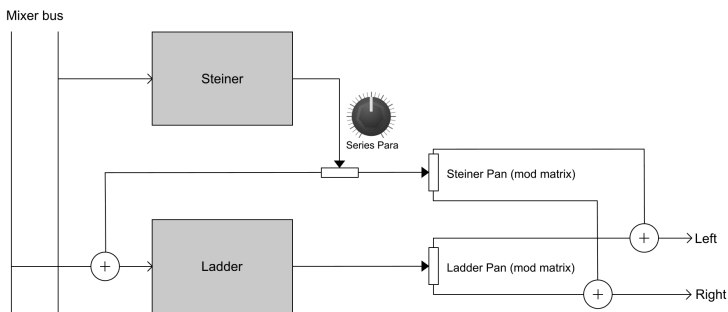

*The PolyBrute filter modules*

### 4.6.2. VCF 1 (Steiner)

VCF 1 is an enhanced version of the Steiner filter that featured prominently in the Brute series synthesizers. Whereas the earlier versions allowed the selection of one filter mode at a time (lowpass, highpass, bandpass or notch), this one is continuously variable between those four modes. So a mix of highpass and bandpass is possible, for example.

The Filter mode knob blends seamlessly between these curves:

- **LP** (Lowpass) allows low frequencies to pass while high frequencies are attenuated.
- **Notch** isn't written on the front panel, but it resides halfway between LP and HP. A Notch filter carves out a middle band of frequencies between its dual cutoff points.
- **HP** allows high frequencies to pass while low frequencies are attenuated.
- **BP** (Bandpass) is the opposite of a Notch filter: it allows a band of frequencies to pass while tapering off the harmonic content on either side of its dual cutoff points.



The Steiner filter tracks the keyboard fairly well, but the Ladder filter tracks the keyboard more accurately. This distinction is important when using a self-oscillating filter as a third oscillator.

#### 4.6.2.1. Brute Factor

Brute Factor is a proprietary filter feedback circuit that does everything from warming up the low end to creating a monstrous growl. The exact effect depends on its interaction with other settings: Mixer levels, cutoff, resonance, etc.

#### 4.6.3. VCF 2 [Ladder]

VCF 2 is similar in design to the most well-known ladder filter on this planet. But unlike the original, VCF 2 is *gain-compensated* to prevent the reduction of lower frequencies that accompanies higher resonance levels.

All of the controls in this module were described in the [Shared features section \[p.30\]](#) except for this one:

#### 4.6.3.1. Disto

Disto is short for "distortion". This adjusts the output of the Ladder filter into its VCA (the Level control). The harder it hits its VCA, the more distortion you'll hear.

### 4.7. Filter FM

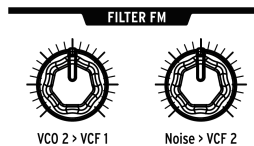

Two of the PolyBrute sound sources have hardwired modulation routes to the filters.

#### 4.7.1. VCO 2 > VCF 1

This knob allows VCO 2 to modulate VCF 1. Try various tunings, wave shapes, the sub-oscillator, and different settings for cutoff and resonance, etc. This can coax the most delicious results from the Steiner filter!

#### 4.7.2. Noise > VCF 2

This knob routes the Noise oscillator to VCF 2. The [Noise Colour knob \[p.26\]](#) determines the frequency content of the Noise generator, and thus controls the character of the modulation fed to VCF 2. Again, try various levels for cutoff and resonance, etc. The more extreme settings are not for the fainthearted!

## 4.8. Envelopes

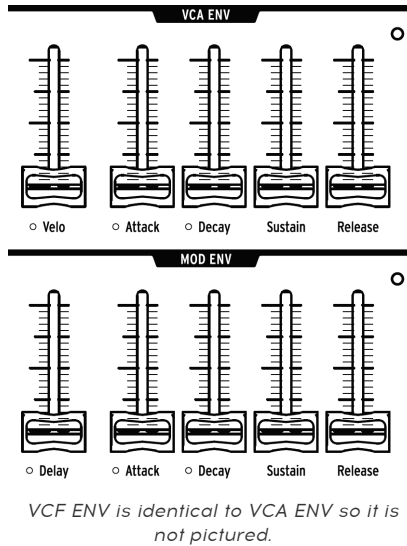

Envelopes are adjustable modulators that shape voltage over time when a note is triggered. PolyBrute has two 4-stage envelopes (ADSR), plus a third with a delay stage (DADSR). Each envelope has an LED to indicate the current level of the envelope; it changes quickly or slowly depending on the settings.

VCF ENV can also serve as a mod source in the Matrix, but by default:

- **VCF ENV** shapes the VCF cutoff frequency, depending on the VCF Env setting for each VCF. It can also be assigned in the Matrix.
- **VCA ENV** controls the overall volume level of the patch.
- **MOD ENV** is freely assignable in the Matrix.

The following graphic shows which segment of an envelope is affected by each parameter.

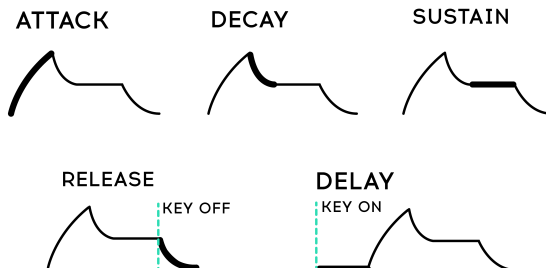



Parameter	Envelope	Min / Max Range	Description
Velo	VCF, VCA only	None / Full	Envelope response to velocity
Delay	MOD only	0-18 seconds	Controls the onset of the MOD envelope.
Attack	All	2 ms - 18 sec	The time the voltage takes to reach maximum
Decay	All	2 ms - 18 sec	The time the voltage takes to reach the Sustain level from maximum
Sustain	All	Zero / Max	Voltage target for the Decay stage. If set to maximum the Decay setting has no effect.
Release	All	2 ms - 18 sec	The time the voltage takes to return to zero after the key is released.

#### 4.8.1. Envelope curves

Hold [Settings] and move an Attack/Decay slider to access the curves for that envelope. Attack has its own curve setting, and the Decay/Release stages share another curve. Several preset options are available. For a list of the presets, see the [Settings chapter \[p.85\]](#).

#### 4.8.2. VCF/VCA velocity modes

Velocity can modulate the envelope times. For example, strings can have a slow attack with low velocities and a fast attack with high velocities. Hold [Settings] and move the Velo slider for VCF Env or VCA Env to access that envelope's velocity modes. A descriptive list of the settings is in the [Settings chapter \[p.85\]](#).

#### 4.8.3. Envelope loop modes

Each envelope can play once, loop two or three times, or loop indefinitely. To access the loop modes:

- VCF/VCA envelopes: hold [Settings] and move the Velo slider.
- MOD envelope: hold [Settings] and move the Delay slider.

A list of the settings is in the [Settings chapter \[p.85\]](#).

#### 4.8.4. Envelope Retriggering

When a voice is retriggered, you can select whether its envelope starts a new Attack from its current level (*single triggering*), or drops to 0 and starts the envelope over again (*multiple triggering*). To set this behavior, hold [Settings] and move the VCA [Sustain] slider. The default is Off (envelopes retrigger from their current level), and setting it On causes envelopes to reset on retriggering.



Tip: Make sure to have some release on your envelope. If you have no release, the amount of envelope will instantly drop to 0 as soon as you release the key. In this case, your envelope will reset from the beginning of the attack, regardless of this setting.

## 4.9. Stereo spread

There are two settings for Stereo spread, which are accessed by holding [Settings] and turning the Stereo knob:

- **Voice pan:** Each voice has a given position in the stereo field
- **Voice + Filter pan:** The "Voice pan" effect described above takes place when the Series/Para control is set to Series. At the other extreme, Parallel mode pans the Ladder filter to the left and the Steiner to the right.

Since the Series/Para parameter is continuous, intermediate settings and crossfades of those two settings are possible.

## 4.10. FX routing selector

This button controls the routing of the Effects section.

- **Insert** runs the entire signal through the effects
- **Send** uses the Delay and Reverb as a side chain (Modulation is always an insert effect)
- **Bypass** removes all effects from the output.

Note that when the signal is dry (effect levels at zero) the signal path is pure analog.



To learn more about this feature, and especially about the Modulation FX Send/Insert Routing, please check out [this section \[p.8\]](#)

## 5. PERFORMANCE CONTROLS

One of Arturia's goals for PolyBrute was to place a wide variety of performance options at your fingertips, and we are proud of what we have accomplished; there are dozens of controls and features that respond instantly when inspiration strikes. Some controls are standard (pitch/mod wheels, channel aftertouch, sustain/expression pedals), and some are quite unconventional (the ribbon controller, the motion recorder, and Morphée, our triple-axis controller).

### 5.1. Wheels

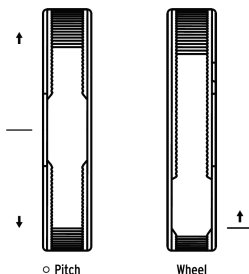

PolyBrute offers a set of pitch bend and modulation wheels. These are often used to liven up a solo, help with the emulation of acoustic instruments, or to do things other instruments cannot. The Pitch wheel springs back to the center/zero position, while the Wheel stays where you put it.

#### 5.1.1. Pitch

The default Pitch wheel range is +/- 2 semitones, but there are seven other ranges available. Hold [Settings] and move the Pitch wheel to open the Bend Range page. Then use the Assign buttons to select the range you want. The maximum range is +/- 24 semitones, or 2 octaves.

#### 5.1.2. The Wheel

The mod wheel (i.e., the Wheel) is not just for vibrato anymore. It can control almost anything via the Mod Matrix: Effects, LFO speed, envelope decay, etc.

It has four options that can be selected instantly using the Wheel button, which is the third of four buttons located to the right of the Wheel itself. The options are Matrix, Cutoff, Vibrato, and LFO1 Amp. These are described in the [Wheel modes section \[p.40\]](#).

## 5.2. Octave buttons

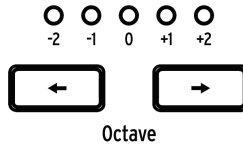

Use [Octave < / >] to transpose the keyboard by octaves. These extend its range to a total of nine octaves. Transposition occurs locally and over MIDI.

If you hold [Settings] while using the Octave buttons, the keyboard will transpose in semi tones. A pop-up display showing the amount of transposition will appear briefly when this is done, and the Octave button(s) will blink as long as the keyboard is transposed.

 The upper and lower keyboard zones can be [transposed independently \[p.39\]](#). MIDI output is transposed. Transposition does not affect the placement of the split point on the keyboard itself.

Press both buttons at once to reset the octave transposition and semitone transposition to zero. In Split mode this must be done for each half of the keyboard.

## 5.3. Morphée

You may never have encountered anything like Arturia's Morphée controller. It's more than an X/Y touchpad; it's also pressure-sensitive, so it operates on the Z axis as well. All three axes are available as sources in the Mod Matrix and can be routed to as many destinations as you like (up to the maximum of 32).

Morphée has three options that can be selected instantly using the Morphée button, which is the fourth of four buttons above the Glide knob. The options are Matrix, Arp / Seq, and Morph.

Morphée also has a dedicated Settings page, with two shortcuts: hold [Settings] and touch the Morphée surface or hold the Morphée button for about 1 second. These options define the Morphée response, and are described [here \[p.41\]](#). The settings are stored per Preset.

## 5.4. Voice/control mode buttons

The four buttons near the wheels allow instant configuration of the voice engine and two of the most-used performance controls. The top two buttons select Voice modes; the bottom two select Control modes.

### 5.4.1. Polyphony

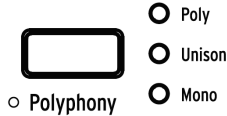

PolyBrute has three voice modes that are selected using [Polyphony].

- **Poly** (polyphonic) allows all six voices to be triggered independently by different notes.
- **Unison** stacks multiple voices on a single key. Learn how to set voice count number [here \[p.38\]](#).
- **Mono** (monophonic) limits the keyboard to playing only one dual-oscillator voice.

In [Split mode \[p.39\]](#) the upper and lower keyboard zones can have different voice modes.

- Upper: use the Polyphony button as normal.
- Lower: hold [Timbrality] and press [Polyphony] to change the voice mode for the lower half.

The LEDs show the status of the selected half.

There are several variations of each voice mode: Cycle, Reset, Note Priority, Legato on/off, etc. To access these options, hold [Settings] and press [Polyphony]. To access these settings for the lower half when in Split mode, hold [Timbrality] for 1 second. The page you'll see depends on the current mode: Poly mode takes you to the [Poly Allocation page \[p.44\]](#); Unison or Mono mode takes you to the [Uni/Mono Allocation page \[p.45\]](#).

#### 5.4.1.1. Unison voice count

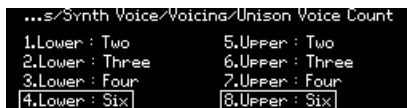

You can define the number of voices used by each zone in Unison mode. Navigate to Settings/Synth Voice/Voicing/Unison Voice Count. Use [Assign 1-4] to set the value for the lower zone and [Assign 5-8] to set the value for the upper zone.

#### 5.4.1.2. Unison detune

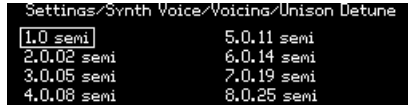

You can now detune in semitones in Unison mode without relying on the Voices modulation lane. Navigate to Settings/Synth Voice/Voicing/Unison Detune. Use [Assign 1-8] to set the detune with values ranging from 0 semitone to 0.25 semitone.

#### 5.4.2. Timbrality

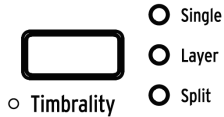

The Timbrality modes change the keyboard layout for sounds A + B. Here's what they do:

- **Single:** the keyboard has one zone; each note triggers one voice that can morph between sounds A + B.
- **Layer:** you can choose from the Morph Layer mode and from the Stereo Layer mode.
  - **Morph Layer:** the keyboard has one zone, with two morphing voices per note. If the Morph control is at zero, sound A is doubled. When it is at maximum, sounds A + B are layered.
  - **Stereo Layer:** in this mode, two voices are allocated for each note played, and it pans them Left and Right. Please note that only 3 voices can be played.
- **Split:** the keyboard has two zones. The lower zone is always sound A; the upper zone can morph between sounds A + B.

The lower zone can trigger the Sequencer or Arpeggiator, so you can play a pattern or arpeggio using the lower zone while playing more notes in the upper zone.

 The lower zone sends / receives on MIDI channel 2 by default. Change this at Settings/MIDI/Channels: select [Assign 3] (Input Channel Lower) or [Assign 4] (Output Channel Lower), then use the Assign buttons to set the value to 1-16 or None.

##### 5.4.2.1. Set the split point

Hold [Timbrality] and play a key to set the split point.

##### 5.4.2.2. Transpose the zones

In Split mode the upper and lower keyboard zones can be transposed independently.

- Upper: use [Octave < / >] as normal
- Lower: hold [Timbrality] and press [Octave < / >] to transpose the lower half.

### 5.4.3. Chord memory

The PolyBrute can memorize and play back chords triggered from one note. To create a chord, hold the [Polyphony] button and play some notes. Release the button when you have entered the desired notes.

Now, all three lights next to the Polyphony button will illuminate, indicating you're in chord mode. Pressing any single key will play the chord you entered and transpose it across the keyboard.

Some things to know:

- The first note pressed is the root note.
- Notes do not have to be entered legato. As long as the Polyphony button is held, you can press keys and shift octaves to edit the chord. This can result in some pretty big chords!
- Short-press the Polyphony button to exit chord mode and clear the stored chord.
- To change the number of notes in a stored chord, you must re-enter the chord from scratch.
- The chord, and whether chord mode is on or off, can be saved per preset.
- In Split mode, you can set the chord to be in either zone by playing the first note above or below the split point. After that first note is pressed, you can add any other notes to the chord in the usual way.

### 5.4.4. Wheel modes

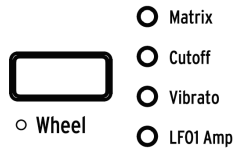

Press the Wheel button repeatedly to select the Wheel assignment:

- **Matrix** allows it to be routed to multiple parameters at the same time.
- **Cutoff** gives it control of the master cutoff frequency, so it's the same as turning that knob.
- **Vibrato** connects an LFO to both VCOs, so the Wheel can add vibrato to the patch without using the Mod Matrix.
- **LFO 1 Amp** lets the Wheel control the modulation amount of any mod route that uses LFO 1 as a source.

Hold the [Wheel] button to access the Vibrato Options page. This allows you to set the Vibrato range and specify whether the source will be LFO1 or a dedicated Vibrato LFO. For details, see [Settings \[p.85\]](#).

### 5.4.5. Morphée modes

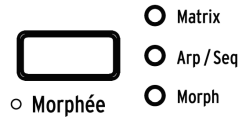

Press the Morphée button repeatedly to select the Morphée assignment:

- **Matrix** allows each of the axes to be routed to multiple parameters at the same time.
- **Arp / Seq** lets Morphée randomize the sequence or arpeggio with Spice, Dice, and Ratchet:
  - **Spice (X axis)** alters velocity and octave without transposing the pitch.
  - **Spice (Y axis)** alters gate time.
  - **Ratchet (Z axis)** subdivides the steps with multiple triggers as pressure increases.
  - **Dice:** Touch with 3 fingers to "roll the dice" and randomize all the Spice parameters at once.
- **Morph** enables morphing on the X/Y axis between sounds A + B. Several response settings are available: hold [Settings] and touch the Morphée surface, or hold the Morphée button for about 1 second. Descriptions are [here \[p.O\]](#).

### 5.5. Glide



When the Glide knob is set to a non-zero value the pitch sweeps from one note to the next. The maximum glide time is 10 seconds. Set the Glide knob 100% to the left to disable glide.

There are several ways to define the glide behavior (time vs. rate, smooth or quantized, etc.). To access that page, hold [Settings] and turn the Glide knob. The options are described in [this section \[p.89\]](#).

#### 5.5.1. Glide in Split mode

When PolyBrute is in Split mode the glide setting is shared between the two zones. But since Split mode assigns the A+B morphing feature to the upper zone, independent glide times are possible: sound A glide time can be zero, and sound B glide time can be non-zero (or vice-versa).



## 5.6. Morph knob

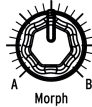

The Morph knob lets you morph manually between sounds A + B. Its position is visible in each mode (Presets, Mods, Sequencer, and Morph): when the knob is turned, a graphic on the left side of the display goes up and down.

The current position of the Morph knob is stored with the patch, and that becomes the starting point for the morph mods. For more information, see the [Morph Mode chapter \[p.73\]](#).

## 5.7. Ribbon controller

That smooth groove in the front panel provides a unique way of controlling a sound. It's like a cross between a paint brush and the fingerboard of a violin; you can add color by touching the surface and then sliding or trilling. Use it to unlock your own "smooth groove".

As with other controls, hold [Settings] and touch the ribbon to access its settings page. Then configure as desired: Should modulation start from where your finger lands, or jump to a certain value based on ribbon dimensions and the modulation amount? Should the mod level return to zero when released or stay where it was? It's up to you. These settings are stored with the patch, so the ribbon can work differently for different situations as needed.

## 5.8. Aftertouch

The PolyBrute keyboard also features Aftertouch (i.e., pressure sensitivity). It can be used to control any parameter through the Mod Matrix: Sweep the filters, add volume swells, or increase the vibrato rate, etc., simply by increasing the pressure on the keyboard with your fingers.

In Mods mode, select Aftertouch as the source (row I) and route it to any destination you like. There's a handful of global aftertouch settings at Settings/Keyboard/Aft Sensitivity.

### 5.8.1. Duophonic Aftertouch

The PolyBrute can even perform a type of duophonic aftertouch, in which only the most recent note or notes played, or either half of a split, will be affected by aftertouch. This is great for soloing with aftertouch over a chord, for example. See the [Expression Control \[p.O\]](#) section of Chapter 12 for details.

## 5.9. Expression pedals

Let your feet have some fun, too. Each expression pedal can have a setting for every patch: filter control, modulation, etc. To select them, navigate to Settings/Expression Control/(Exp1 Settings or Exp2 Settings). The options are identical except for one: Pedal 1 can control the master Volume, and Pedal 2 can be a mod source in the Matrix.

## 5.10. Motion recorder

The Motion Recorder can record the relative movements of any **one** control (knob, fader, ribbon, etc.), with only a few [exceptions \[p.43\]](#). Try this:

1. Activate the "Rec Arm" button. This puts the recorder in recording mode.
2. Hold down a key to start the recording, and keep it down for now.
3. Sweep the Master Cutoff knob in an obvious pattern.
4. Release the key to stop the recording.
5. Deactivate the "Rec Arm" button.
6. Set the Play button to Once.
7. Play one note. The filter sweep plays back once and stops.
8. Set the Play button to Loop.
9. Play one or more notes. The filter sweeps for each voice until its key is lifted.
10. Release all keys to stop playback.

Each patch can store its own Motion recording and the status of the Play button (Off, Once, Loop).

Here's how it works:

- A Note On starts the recording, and if you play a chord, the first Note Off stops it.
- The first control you move after the Note On is the one being recorded.
- The original value of the control becomes the "zero point" for playback.
- The relative motion of the control is captured, not the actual parameter values.
- When recording is finished, the parameter returns to its original value (the zero point).
- If the parameter value is edited, the new value becomes the zero point for playback.
- If the motion recording is longer than the duration of the note, playback may continue during the release stage.

### 5.10.1. The Stretch factor

The Motion Recorder Rate control adjusts the playback speed of the captured control movements. Its range is from 1/8th of the original speed to 8 times the original speed. Normal speed is at the center detente position.

### 5.10.2. Exceptions

There are a few controls which the Motion Recorder will not capture:

- Sequencer parameters (Gate, etc.)
- Motion Recorder Rate
- Fine Tune
- Phones
- Master Volume
- The Mod amount knob
- Buttons

And on the "plus" side, the Motion Recorder will capture all three axes of the Morphée controller (X, Y, and Z).

## 5.11. Voice allocation modes

When a note is triggered the PolyBrute can play as many as six voices on a single key. The Voice allocation modes let you define this response for each patch. They are accessed by holding [Settings] and pressing one of the [Voice mode buttons](#) [p.38].

The page you'll see depends on the Polyphony mode for the current zone: Poly mode takes you to the Poly Allocation page; Unison or Mono mode takes you to the Uni/Mono Allocation page. All options are described in the following sections.

### 5.11.1. Polyphonic allocation

The Poly Allocation options are identical for the upper and lower zones regardless of the Timbrality mode (Single, Layer, or Split). The lower zone settings can be accessed even when the keyboard is not split.

To access these settings when the Single/upper zone is in Poly mode, hold [Settings] and press [Polyphony]. To access these settings for the lower half when it is in Poly mode, hold [Timbrality] for 1 second.

Choose one setting from the Poly column and one from the Steal column:

- **Poly Cycle** uses the first available voice, then the next higher-numbered voice, and so on.
- **Poly Reset** uses the first available voice and keeps using it until it is stolen.
- **Poly Unison** allocates voices for unison playing in polyphonic mode. See [Poly Unison Mode](#) [p.44] below for details.
- **Poly Reassign** cycles through the voices as different notes are triggered, but reuses an existing voice if the same note is played again.
- **Steal Oldest** tells PolyBrute to steal the note that has been held the longest first.
- **Steal Lowest** tells PolyBrute to steal the note with the lowest velocity played in a chord first.
- **Steal None** tells PolyBrute not to steal a voice when no voices are available.

#### 5.11.1.1. Poly unison mode

When Poly Unison is selected, the PolyBrute dynamically allocates voices for playing in unison but still polyphonically, offering the best of both worlds within the PolyBrute's total voice count.

- The first key played uses all six available voices.
- The second key played splits voices evenly between the two notes: 3 for each note.
- The third key played splits voices evenly between the three notes: 2 for each note.
- The fourth key played reassigns that were allocated first to the last triggered key: 1 voice for the first note, 1 for the second, then 2 and 2 for the next notes, respectively.
- Playing five keys similarly reassigns the first allocated voices: 1 voice for each of the first four notes, then 2 voices for the final note.
- Playing six keys assigns the voices at 1 per note, such that no note is actually playing a unison.

## 5.11.2. Unison / mono allocation

The Uni/Mono Allocation options are identical for the upper and lower zones regardless of the Timbrality mode (Single, Layer, or Split). The lower zone settings can be accessed even when the keyboard is not split.

To access these settings when the Single/upper zone is in Unison or Mono mode, hold [Settings] and press [Polyphony]. To access these settings for the lower half when it is in Unison or Mono mode, hold [Timbrality] for 1 second.



To define the number of voices used by a zone in Unison mode, read [this section \[p.38\]](#).

Choose one setting from the Priority column and one from the Legato column:

- **Priority Lower:** The lowest note is played and higher notes are ignored.
- **Priority Higher:** The highest note is played and lower notes are ignored.
- **Priority Last:** The held note can be stolen by a higher or lower note.
- **Legato On:** Only retriggers the envelopes after all notes have been released, so successive notes will slur.
- **Legato Off:** Every note played retriggers the envelopes.
- **Legato Glide:** If glide is active, playing legato notes does not retrigger the envelopes and also glides from one pitch to the next.

## 6. WORKING WITH PRESETS

The focus of this chapter is preset management: loading, saving, comparing, etc. Follow these links to learn how to [initialize a preset \[p.15\]](#), [create a preset from scratch \[p.14\]](#), or to [edit an existing preset \[p.22\]](#).

### 6.1. Selecting a preset

The process of selecting one of the 768 internal presets was covered [here \[p.12\]](#). But it's easy: Select the Presets mode button, select a bank with an Assign button (1-8), then select one of the Matrix buttons (A1-L8).

If you're looking for a preset in a particular category, such as a Brass preset, hold the Preset button and turn the Amount knob. As you scroll through each category, it will be displayed onscreen and the Matrix buttons for the presets in the current bank that belong to that category will light up.

### 6.2. Snapshots

PolyBrute can save up to 5 Snapshots of edited presets for instant comparison. Here's how it works:

- To save a Snapshot of an edited patch, press [Save] once.
- To recall a Snapshot or compare it to the current preset, hold [Settings] and press [Save]. The display looks like this:

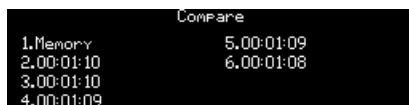

Compare	
1.Memory	5.00:01:09
2.00:01:10	6.00:01:08
3.00:01:10	
4.00:01:09	

- The Snapshots are listed chronologically (hours:minutes:seconds), with the most recently selected Preset in location 1.
- Use [Assign 2-6] to audition a specific Snapshot of a previous edit.
- To exit Snapshot mode, press [Settings] or one of the large Mode buttons.

Here are a few things to know about Snapshots:

- All previous Snapshots are erased only when a new preset has been loaded and a new Snapshot has been saved.
- A Snapshot can't be taken if no edits have been made since taking the previous Snapshot, or since loading the most recent preset.
- A Snapshot is taken automatically of the previous state when a preset is loaded (unless no edits were made, as mentioned above).

Snapshots allow you to view the stored presets while editing the current preset. This is useful in two ways:

- To compare the edited state of the preset to the unedited (stored) version, or to any other preset
- To preview another preset location before overwriting it with an edited preset.

### 6.3. Random patch generation

PolyBrute can generate a random patch for you by choosing sounds A and B from different patches, changing the morph knob value, moving the result to sound A, and then repeating most of that process a random number of times. The generated patch can then be tweaked, saved as a Snapshot, or saved as a new preset.

This feature is found at Settings/Preset Info/Generate. Press [Assign 3] to generate the random patch. The name of the random patch will change to "Generated".

### 6.4. Panel mode

In Panel mode the position of each knob determines the sound. This is the mode to use if you want 1:1 feedback between the parameters and the sound you are editing: what you see is what you get.

If you've edited the current patch, you might want to [take a Snapshot \[p.46\]](#) before entering Panel mode so you can get back to that edit. To do this, press [Save] once. Then press [Program < / >] at the same time to load the panel settings. This replaces the current preset with the actual positions of the knobs and sliders. To restore the edited preset, hold [Settings], press [Save], and use [Assign 1-6] to select the most recent Snapshot.

### 6.5. Saving a preset

The [Save] button is used to take Snapshots, do a "Quick Save" to the current location, or save an edited Preset to a new location. Summary first, then the details:

Function	Action	Description
Snapshot	Press [Save] once	Temporary buffer for comparing an edited preset with others
Quick Save	Press [Save] three times	Edited preset is saved to current location
Save Preset	Hold [Save] + Press [ Assign 1-8 ] (optional) + Press [Matrix A1-L8]	Save preset to another location

Snapshots were described in [the previous section \[p.46\]](#).

#### 6.5.1. Quick Save

To save an edited preset quickly on top of the original version, press [Save] three times. This overwrites the current preset location, so we made it a deliberate action to avoid accidents.

## 6.5.2. Save to another location

This process allows you to save an edited patch to any one of the 768 internal memory locations. It's basically the same as selecting a preset in the first place, except you hold the Save button first:

1. Hold [Save] until step 4. After 1 second the display says "Hold Save and Press a Matrix Cell to Save."
2. Use [Assign 1-8] if you want to store the patch to a different bank.
3. Use Matrix buttons A1-L8 to select a location (cell) within the selected bank.
4. Press the Matrix button. The target cell patch is loaded into memory so you can hear it before overwriting it.
5. To exit Save mode without making a change, use [Assign 2] or select a different mode.
6. To rename the patch you are saving and select its category, see the next two sections.
7. If you like the current name and category, use [Assign 7] to confirm each choice.
8. The selected location is overwritten with the edited patch.

### 6.5.2.1. Give it a name

A patch can be renamed during the Save procedure if you want. [Assign 2-7] show the options:

- Exit Save mode with [Assign 2] (or select a different mode).
- Select a specific character with the Amount knob.
- Press [Assign 3] or [Assign 4] to jump to the first character in a set ([blank], A, a, O, [period]).
- Select another character field with Assign 5 or 6. Max. length: 20 characters.
- Use [Assign 7] to confirm the name and proceed to the Category window.

### 6.5.2.2. Select a category

A patch can be assigned a category during the Save procedure. [Assign 2-7] show the options:

- Revert to previous section with [Assign 2], or select a different mode.
- Select a category with the Amount knob or use Assign 3 through 6.
- Use [Assign 7] to confirm the category. The patch will be saved to the selected location.

## 6.5.3. Use PolyBrute Connect

PolyBrute Connect offers a convenient alternative for saving, naming, and categorizing presets. It can also be used to search for specific patches by name or category. And its Projects feature can organize patches into different groups for live performances and session work. In other words, if you haven't already done so, be sure to install the software and try it out!

## 7. WORKING WITH MODS

The Modulation Matrix is a wireless patch bay that can route the PolyBrute's modulation sources to one or more destinations. Almost any parameter with a knob or fader can be a destination, and each can be modulated positively or negatively.

The mod routes are arranged in a 12 x 8 grid: sources are in rows A-L, and destinations are in columns 1-8. Four separate banks of mod routes can be selected with Assign buttons 1-4. Each mod route can have its own destination, and the same destination can be used for multiple mod routes. 32 routes are available, and up to 64 connections can be made within those 32 routes.

### 7.1. Creating a mod route

Setting up a modulation route is quick and easy. Press the Mods button to enter Mods mode. The display looks something like this:

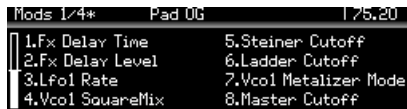

Mods 1/4*	Pad 0G	125.20
1.Fx Delay Time	5.Steiner Cutoff	
2.Fx Delay Level	6.Ladder Cutoff	
3.Lfo1 Rate	7.Vco1 Metalizer Mode	
4.Vco1 Squaremix	8.Master Cutoff	

The top row of the display provides basic information: For example, "Mods 1/4" means you're on the first of four pages of mod routes. The patch name and current tempo are also shown.

The eight numbers below that show the current assignments for mod routes 1-8 on the first page of mod routes. These numbers correspond to [Assign 1-8]. Keep that in mind as we work through the following sections.

#### 7.1.1. Select the source

This part is simple. The 12 modulation sources are printed on the front panel in rows A-L. If you want to use LFO 3 as a mod source, for example, you'll use row F to set up the route.

#### 7.1.2. Assign a destination

There are no "fixed" destinations: any mod route can modulate any available parameter. Destinations are selected by holding [Assign 1-8] and activating a parameter control.

For the following example, set the Modulation Intensity in the Effects module to something obvious. We'll use LFO 3 as a mod source.

1. To select Modulation Intensity as the destination, hold Assign button 1 and turn that knob.
2. The display shows "Fx Modul Intensity" as mod destination 1.
3. To connect LFO 3 to the Intensity level, press Matrix button F1. The button turns purple to indicate the connection, and the display shows "Amount: 0%".
4. Set a mod level with the Amount knob. (LFO 3 is a bipolar source by default, so positive or negative levels give the same result.)
5. Play a note and listen: the Intensity fluctuates according to the settings of LFO 3.
6. Try various LFO 3 settings to change the mod speed and shape, etc.



7. To break the mod connection, press button F1 again. A dark button means there is no connection.

8. Press F1 again to reconnect the route, then press any other Matrix button. F1 turns blue to indicate an active mod route, and the purple button indicates the current selection.

After the eight routes in a mod bank have been used, select another bank with [Assign 1-4]. Then connect the sources and destinations as shown in the previous example.

#### **7.1.2.1. 1 source, 2+ destinations**

To route the same source to two or more destinations, trace your finger down from the first destination until it reaches the desired row (F, for example). Activate the route and give it an amount as in steps 3 and 4 above. Then do the same for the second destination, even if it's in a different mod bank. Repeat the process for as many destinations as you like.

#### **7.1.2.2. 2+ sources, 1 destination**

To route two or more sources to a single destination, trace your finger down from the destination until it reaches the row that belongs to the first source. Activate the route and give it an amount as in steps 3 and 4 above. Then do the same for the second source, and so on.

#### **7.1.2.3. Less-obvious destinations**

##### **No hardware control**

Some destinations don't have a hardware control, such as the main VCA, LFO amplitudes, Global Pitch (VCOs 1+2 combined), Filter Pan, and Voice Pan. To view the list Hold [Assign 1-8] and turn [Mod Amount], then release the Assign button when you see the desired destination appear in the appropriate line of the PolyBrute display. Here is a list of the possible destinations:

1. VCA
2. LFO1 Amp
3. LFO2 Amp
4. LFO3 Amp
5. Pitch Global
6. Steiner (Filter) Pan
7. Ladder (Filter) Pan
8. Voice Pan
9. Vibrato Depth
10. Vibrato Speed

##### **Right-side controls**

Some destinations could be overlooked because they're on the other side of the Matrix panel. But most of those can be modulated, too. For example, hold [Assign 1-8] and turn these controls:

- Stereo Spread
- Fine Tune assigns VCOs 1 + 2 as a single destination labeled "Pitch Global."
- Every knob in the Effects section, plus the Motion Recorder Rate control

The only output levels that *can't* be assigned as destinations are the Phones and Master Volume.

#### 7.1.2.4. What's the limit?

You can use these methods to set up as many as 64 connections between sources and destinations. If you try to add a 65th mod connection, the message "No More Slots Available" lets you know you've reached the limit.

Descriptions of each source are [here \[p.52\]](#). For information on a particular destination, refer to its section in the manual.

 To delete a modulation destination, hold the Panel left arrow and press the Assign button. The destination name will be replaced with the word "Empty".

#### 7.1.3. Edit an existing modulation

If you want to adjust the level of an existing modulation, that's easy too. If you're not already there, enter Mods mode and locate the source on the front panel and the destination in the display. Use [Assign 1-4] to locate the destination if it isn't on the current Mod page. The Matrix button that controls the mod route is lit blue unless it's already selected, in which case it's purple.

It's easy to be sure you've found the right mod route: just disable it by pressing it once. Then re-enable it and use the Amount knob to dial in the right level.

 To reset a mod level to zero immediately, hold the Panel left arrow and turn the Amount knob.

#### 7.1.4. Modulate a mod route

You can use a mod route to modulate another mod route. For example, if you want LFO 2 to modulate the mod route "LFO 3 > Pitch Vco1":

1. [Initialize a patch \[p.15\]](#) and enter Mods mode. The [Assign 1] column shows "1.Pitch Global" by default.
2. Press F (button F in column 1) to connect "LFO 3 > Pitch Global" and give it an amount.
3. Hold [Assign 2] and press F1. The [Assign 2] column shows "Amount 1.F1" in the display. This means "Mod bank 1, Matrix cell F1" is now a destination.
4. Press button E2 to connect LFO 2 to mod route 1.F1 and give it an amount.
5. Hold a note: LFO 2 modulates the amount of "LFO 3 > Pitch Global". Try various settings for LFOs 2 and 3 to make the results more obvious.

To summarize, after step 4 you can use the [Assign 2] column to route any of the other 12 sources to modulate the destination assigned to Matrix cell F1.

It's also possible to modulate a mod route from a different page. To do this,

- Locate the target mod route: be sure it is active (lit) and has an amount assigned.

- Select a different [Assign 1-4] button: this is the modulation bank where the new mod route will be.
- Hold the new Assign button until the last instruction.
- Press the original Assign button (the one with the target mod route that you want to modulate).
- Press the Matrix button that contains the mod route (D3, or whatever). The connection is made.

**i**: This method cannot be used to connect two mod routes under the same destination (i.e., under the same Assign button in the same modulation bank). This will show an error message: "Cannot Assign Mod Amount on the Same Column."

### 7.1.5. Erase all mod routes

To clear the Modulation Matrix, hold the Panel left arrow and press the Mods button.

## 7.2. Mod source list

Row	MOD source	Notes
A	VCF Env	Output voltage of the VCF envelope
B	Mod Env	Output voltage of the Mod envelope
C	Voices	Output voltage based on voice number
D	LFO 1	Output from LFO 1 (unipolar or bipolar, depending on the LFO setting)
E	LFO 2	Output from LFO 2 (unipolar or bipolar, depending on the LFO setting)
F	LFO 3	Output from LFO 3 (unipolar or bipolar, depending on the LFO setting)
G	Key / Seq	Triggers from the keyboard, the sequencer/arpeggiator, and incoming MIDI notes
H	Velocity	Output voltage based on MIDI velocity value
I	Aftertouch	Output voltage based on key pressure
J	Wheel + X	Output voltage of the Wheel summed with Morphée axis X (must assign the Wheel to Matrix)
K	Ribbon + Y	Output voltage of the ribbon controller summed with Morphée axis Y
L	Exp 2 + Z	Output voltage of Expression pedal 2 summed with Morphée axis Z

### 7.2.1. What is the Voices source?

The Voices mod source provides certain values based on the voice number. As with any source, it can be used on any parameter (VCO tuning, stereo position, filter cutoff, etc.), with the modulation range set by the mod amount.

There are eight settings for the Voices source, which are accessed by holding [Settings] and turning the [Stereo] knob:

- **Follows Stereo:** The Voices source uses the same signal as the [Stereo Voices Mapping \[p.35\]](#)
- **Gradual:**
  - Voice 1 sends a -1 value (maximum negative)
  - Voice 2 sends a -0.6 value
  - Voice 3 sends a -0.2 value
  - Voice 4 sends a +0.2 value
  - Voice 5 sends a +0.6 value
  - Voice 6 sends a +1 value (maximum positive)
- **Binary:** alternates between +1 and -1 as each voice is played
- **Constant:** fixed at +1
- **Random:** sends a random value between -1 and +1
- **Random Binary:** randomly sends either -1 or +1
- **Unipolar Rise:**
  - Voice 1 sends a 0 value
  - Voice 2 sends a +0.2 value
  - Voice 3 sends a +0.4 value
  - Voice 4 sends a +0.6 value
  - Voice 5 sends a +0.8 value
  - Voice 6 sends a +1 value (maximum positive)
- **VCA Env:** uses the VCA envelope signal for each voice
- **Centered:**
  - Voice 1 sends a zero value
  - Voice 2 sends a +1 value (maximum positive)
  - Voice 3 sends a -1 value (maximum negative)
  - Voice 4 returns to zero
  - Voice 5 sends a +0.5 value (50% positive)
  - Voice 6 sends a -0.5 value (50% negative).

## 8. SEQUENCER MODE

This chapter covers the features of the Seq/Arp section, which includes the Sequencer, the Arpeggiator, and their hybrid, the Matrix Arpeggiator. Here's a brief overview of each:

- **Sequencer mode** [p.57] contains a 64-step sequence that can trigger notes, modulation events, or both. Each step in the sequence can contain up to 6 notes. Sequence length is adjustable.
- In **Arpeggiator mode** [p.56] the notes you hold down are stepped through in a variety of orders, and repeated in higher octaves.
- **Matrix Arpeggiator mode** [p.64] lets you construct a 16-step framework that can generate complex arpeggios.

When a preset is saved, the data for all three modes is saved with it.

 The Timbrality Split LED flashes if [SEQ] is active when a preset is loaded. This tells you that the keyboard has been split, and that the lower part of the keyboard will transpose the sequence.

PolyBrute doesn't need to be in Sequencer mode to record or play sequences, but you must enter Sequencer mode to edit them. So when you're ready, press the round Sequencer mode button to enter Sequencer mode.

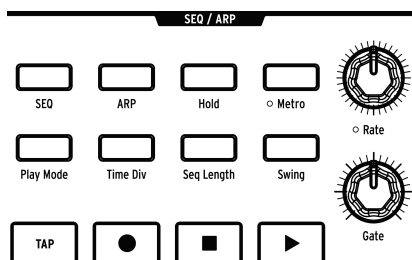

### 8.1. Common features

The Sequencer, Arpeggiator, and Matrix Arpeggiator have several common features, so we'll cover them once in this section.

 The Matrix buttons provide good visual feedback as the various Seq/Arp parameters change. This can be very helpful as you learn about the features.

### 8.1.1. The Home page

Press the Sequencer button and the PolyBrute takes you to the top level of Sequencer mode. We'll refer to this as the home page. What the home page shows depends on whether the Sequencer or Arpeggiator is active.

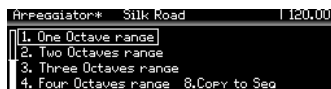

- With [SEQ] active, the Matrix view options and several track operations are available.
- With [ARP] active, the Octave range and Copy to Seq options are available.

### 8.1.2. Hold mode

Enable [Hold] and the Seq/Arp pattern continues playing after the keys are released.

### 8.1.3. Metronome

Press [Metro] to activate the metronome. To set the metronome level and pre-count mode, hold [Metro] for 1 second.

### 8.1.4. Time divisions

Press [Time Div] to access the Time Division menu. This sets the underlying step duration on which sequences and patterns are based. Settings range from 1/2 notes to 1/32nd notes, and include dotted, binary, and triplet note value options.

[Assign 1-5] select the step duration and [Assign 6-8] select the note value option. Press [Time Div] repeatedly to step through the time divisions for the selected note value.

### 8.1.5. Swing percent

Hold [Swing] to select the swing percentage. This only affects playback; it does not alter the location of the original notes.

### 8.1.6. Rate

Rate dials in the sequencer tempo, from 30 to 240 beats per minute. The tempo appears in the upper-right corner of the display in every mode. When locked to an external clock, the rate changes in exact divisions of time based on the incoming clock.

To adjust the tempo in increments of 0.10 beats per minute, hold [SEQ] and turn the Rate knob.

### 8.1.7. Gate

The Gate knob controls the duration of each step. At maximum, each note overlaps the following step by 195% of the Time Div setting.

### 8.1.8. The transport

The Seq-Arp section offers standard transport controls: Record, Stop, and Play. There is one button that is not as common, though: [Tap]. It is explained in the next section.



To send an All Notes Off *and* All Sounds Off command, press the Stop button quickly three times.

### 8.1.9. Tap

Use this button to tap in the tempo. You'll see the tempo change in the display. The sequencer engine updates with every tap, so you can keep tapping if you need to follow a drifting tempo.

## 8.2. The Arpeggiator

The [ARP] button activates the Arpeggiator, which steps automatically through the notes being held. Each note of the arpeggio becomes a red step in the Matrix, and a purple step shows the current playback position.

When [Hold] is active you can keep adding notes to the arpeggio as long as one key is held down. An arpeggio can play up to 32 notes.

The arpeggiator responds to key velocity, so individual notes can be more or less prominent depending on how hard a key was played. Results depend on the Velo slider settings for VCF ENV and VCA ENV.

### 8.2.1. ARP home page

Enter Sequencer mode and press [ARP]. You'll see the Arpeggiator mode home page, where the Octave range can be set and an arpeggio can be converted into a sequence for Sequencer mode. Other pages are shown temporarily while changing Arpeggiator mode settings, but the Arpeggiator returns to the home page after 1 second.

#### 8.2.1.1. Octave range

Use [Assign 1-4] to set the Arpeggiator Octave range between 1 and 4 octaves. When you hold notes that span more than an octave, the overall range of an arpeggio can be much greater.

#### 8.2.1.2. Copy to Seq

Whatever the Arpeggiator is doing can be converted into a sequence for additional editing in Sequencer mode, or simply to preserve a moment of pure musical magic. Use [Assign 8] to transfer the Arpeggiator output into the Sequencer.

## 8.2.2. Play Mode: Arp

Hold [Play Mode] to view the Arp Play Mode page, and use [Assign 1-7] to select an option. These set the playback direction for an arpeggio.

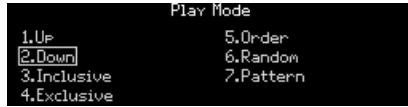

- **Up** steps through the notes from lowest to highest and repeats.
- **Down** steps through the notes from highest to lowest and repeats.
- **Inclusive** plays from lowest to highest and back down, repeating the edge notes.
- **Exclusive** plays from lowest to highest and back down, *not* repeating the edge notes.
- **Order** plays the notes in the order they were inputted.
- **Random** plays the held notes in random order.
- **Pattern** generates repeating patterns at random. It's deep, so it has [its own section \[p.57\]](#).

Press [Play Mode] repeatedly to step through the various options.

### 8.2.2.1. Pattern mode

There is a staggering range of potential outcomes with the Arpeggiator Play Mode set to Pattern. Here are the basic concepts, but experimentation will teach you the most.

- Notes that are held are used to generate a pattern with a default length of 16 steps.
- The pattern can pick notes from any octave within the Octave range settings.
- When the number of held notes changes, a new random array of notes is generated.
- The lowest held note is twice as likely to be heard as the other notes. This helps to emphasize the root note.
- To define the length of the pattern, hold [Seq Length] and press a Matrix button. (They are grouped in sets of three.) The purple buttons show the current length.
- The maximum pattern length for this mode is 32 steps.

Remember, if the Arpeggiator generates a pattern you want to keep, use [Copy to Seq \[p.56\]](#) to transfer it to Sequencer mode.

## 8.3. The Sequencer

The [SEQ] button activates the Sequencer, with which you can create a polyphonic sequence of up to 64 steps, including velocity, accents, slides, and three parallel modulation tracks. Sequences can be recorded in real time, and every step can be entered and edited manually.



♪: Notes from the sequencer can be used as a modulation source through Matrix row G.



### 8.3.1. Sequence playback

When [SEQ] is active the Split LED flashes to indicate that a sequence is ready to go; just play a key on the lower zone and it will start, or press the Play button.

 A sequence plays its original pitches when the second C from the left is triggered, but it transposes if a different note is triggered. It's easier to know what you'll hear if you record a sequence thinking of C as the root note; for example, if you want to hear an E minor sequence when you play an E, record the sequence in C minor.

#### 8.3.1.1. Single/Split modes

The keyboard is split in Sequencer mode, with the lower zone triggering and transposing the sequence and the upper zone open for playing live. Hold [Timbrality] and press a key to set the split point.

#### 8.3.1.2. Split mode: Mono vs. Poly

When [Timbrality] is set to Split and the lower zone is set to Mono, the playback of a polyphonic sequence is affected: only the lowest note in the sequence is played. The sequencer still transmits polyphonic data via MIDI, though.

#### 8.3.1.3. Layer mode

When [Timbrality] is set to Layer every note is doubled in the lower and upper zones. The lower zone triggers and transposes the sequence and the upper zone can be played live. Hold [Timbrality] and press a key to set the split point.

## 8.3.2. Live edits

### 8.3.2.1. Matrix row labels

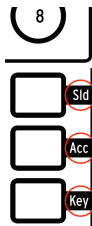

Each row of Matrix buttons has a specific function in Sequencer mode. The labels on the right side of the Matrix panel tell you what they do when lit:

- **Slid** means a slide is active for this step. When active it follows the Glide value. When off (dark) there is no Glide. The Glide setting must be high enough for a Slide to be heard.
- **Acc** adds an accent to that step.
- **Key** is where the note events live. A red step means you'll hear a note; a dark step means you won't, even if the other two buttons for that step are lit.

### 8.3.2.2. Mute/unmute steps

You can mute or unmute any step in the sequence without entering Step edit mode. Just find its location in the Key row, and press that button to mute and unmute the step.

You can mute several steps at one time by holding the **last** button of the range to be disabled and then pressing the first button (i.e., hold the right one, press the left one). All of the included events are disabled. This works whether a sequence is looping or not.

### 8.3.2.3. Accents and slides

Use the buttons in the **Acc** row to toggle Accents on and off for specific steps.

Likewise, use the buttons in the Slid row to toggle Slides on and off for specific steps. The Slide happens *into* the selected note; i.e., from the note *before* the selected note to the selected note. Remember, the Glide setting must be high enough for a Slide to be heard.

You can add or remove several Accents or Slide events at the same time. It's sort of like tying notes together:

- **Add them:** hold the first Accent or Slide button and press another of the same type further to the right (hold *left*, press *right*). All of the included buttons will gain an event for any active notes.
- To **remove them**, reverse the order: hold the last Accent or Slide button in the desired range and press another of the same type further to the left (hold *right*, press *left*). All of the included events are disabled.

For these and more sequencing tips see the [Step Record / Edit chapter \[p.68\]](#).

### 8.3.2.4. Change step length [tie notes]

There are two ways to change the length of a step (i.e., tie a note): the Bracket way and the Knob way.

#### The Bracket way

To make a step longer, hold its Matrix button for less than 1 second and press a button to the right. You have just put "brackets" around the length of the note. The button LEDs indicate the note duration: the brightest step is the original note, and the buttons to the right are lit more dimly to show that the note is tied. It's okay for notes to overlap, if polyphony allows.

To shorten a step, hold its Matrix button for less than 1 second and press a button that is closer to the source note (i.e., make the bracket smaller). This method can't be used to return the note duration to a single step, though. To do that requires the Knob method.

#### The Knob way

To make a step longer or shorter, hold its Matrix button and turn the Amount knob within 1 second. (If you hold the Matrix button for 1+ seconds before turning the Amount knob, the Record light turns red and the Matrix buttons change colors. This means you've entered step edit mode. The full details about step editing are [here \[p.70\]](#).)

- Turn the Amount knob clockwise to lengthen the step and more red LEDs appear to the right, with the first one brighter than the tied steps. Notes can be extended to the end of the sequence.
- Turn the Amount knob counter-clockwise; fewer red LEDs means the note or chord has been shortened. If the notes are extra long, keep turning the knob until you see some red LEDs go dark; then adjust the step as needed.

### 8.3.2.5. Step length, 6 voices and MIDI

The sequencer and the voices are independent. So a legato type of playback might not sound the same depending on the [voice allocation mode \[p.44\]](#). As with [note stealing \[p.O\]](#), this is not handled within the sequencer.

There can be up to 6 notes per step, and their individual lengths are stored within each step. For example, if you have a sequence like this:

- Step 1: [CO; DO; EO; FO; GO; AO], each with a note length of 10 steps
- Step 2: [C1; D1; E1; F1; G1; A1], each with a note length of 10 steps
- During playback, on step 3 you'll have all 12 notes On over MIDI, and the 6 playing voices will depend on the voice allocation mode. In other words, legato voice-playing isn't recorded with the sequence.

### 8.3.3. SEQ home page

Enter Sequencer mode and press [SEQ]. You'll see the Sequencer mode home page, where the Matrix view options and several track operations are found. Other pages are shown temporarily while changing Sequencer mode settings, but the Sequencer returns to the home page after 1 second.

#### 8.3.3.1. View steps 1-32, 33-64

A sequence can contain up to 64 steps, which is more than the Matrix panel can display at one time. Use [Assign 1 + 2] to switch the view between steps 1-32 and steps 33-64. You can use this during playback, recording, or editing.

#### 8.3.3.2. Notes: Overdub ON/OFF, mute



[Assign 3] selects the Notes view in the Matrix panel, and also provides different options for [Assign 7+8] than are shown in the Modulations view (see below).

- [Assign 7] toggles Record mode between Overdub ON and Overdub OFF.
- When not recording, [Assign 8] can temporarily mute the sequence note data.
- While recording, [Assign 8] becomes "Erase Current Step." Hold [Assign 8] and press a step to erase it.

#### 8.3.3.3. Modulations: Mod ID, Erase mods

[Assign 4] selects the Modulation track view in the Matrix panel, and also provides different options for [Assign 5-8] than are shown in the Notes view (see above).

- [Assign 8] is alone on the right side if a mod track has not been recorded yet. It is used to erase a mod track: Hold [Assign 8], press [Assign 5-7], and that mod track will be erased.
- [Assign 5-7] show the names of the controls that are recorded on the three mod tracks.

#### 8.3.3.4. Mute the notes

In case you missed this [earlier \[p.61\]](#): When the sequence is not in a Record mode, the [Assign 8] button (Toggle Mute) is also active in Modulations view (even though you can't see it). Use it if you want to hear what the Modulation tracks are doing while holding some keys.

### 8.3.4. Play Mode: Seq

Hold [Play Mode] to view the [SEQ] Play Mode page, and use [Assign 1-4] to select an option. These set the playback direction for the sequence.



- **Forward** plays the sequence from the first step to the last, then starts at the beginning again.
- **Pendulum** plays the sequence forward and then backward, repeating the first and last steps.
- **Random** can trigger any step inside the sequence length, even steps that contain no data.
- **Walk** moves according to probability, not chance. On each step there is a 50% chance that the next step will be the one to the right, a 25% chance the same step will repeat, and 25% chance that the *previous* step will play.

Press [Play Mode] repeatedly to step through the various options.

### 8.3.5. Sequence length

A sequence can be as short as 1 step and as long 64 steps. The fastest way is to hold [Seq Length] and use [Assign 1-4] to select one of the preset lengths. You can set a sequence to any other length, though:

- For lengths from 1-32 steps, hold [Seq Length] and touch any of the three buttons in the last step.
- For lengths over 33 steps, press [Assign 2] to access steps 33-64 on the Matrix buttons, then touch any of the three buttons in the last step.

#### 8.3.5.1. Extend

The Extend feature doubles the length of the current sequence by copying the existing step data and pasting it onto the steps outside the current sequence length. This can be done repeatedly until the maximum length of 64 steps has been reached.

Hold [Seq Length] and press [Assign 5] to extend the sequence.

### 8.3.6. Real-time recording

Real-time recording remembers velocity levels, note duration, and legato playing for up to six voices, plus activity on the first three controls you move. You can record in real time and edit the sequence in step time later.

You may want to configure the Metronome ahead of time: hold [Metro] for 1 second. On that page you can set the metronome volume and enable or disable the count-in feature.

There are three ways to start a real-time recording:

1. Hold the Record button and press Play once. Both buttons flash, and recording begins at the first step when you touch a key.
2. Press and release the Record button (it lights red), then press and release Play. If count-in is enabled the metronome will give you four counts before recording begins; otherwise recording starts when you release the **Play** button.
3. You can also enter real-time recording with a press/release of the Record button while the sequencer is playing.

To record control movements, return to the home page and press [Assign 4]. Then read the [Modulation track section \[p.64\]](#).



♪ If a control is turned while recording in real time, the sequencer will exit Record mode after one loop.

#### 8.3.6.1. Spot erase

You can erase a note by pressing the [Tap] button at just the right time. Keep holding [Tap] to erase several notes. For greater precision, try [Step editing mode \[p.70\]](#).

### 8.3.7. Step recording

There's a lot of overlap between step recording and step editing, so most of that information is in the [next chapter \[p.68\]](#). But to summarize, in Step mode you can:

- Enter, edit, or replace a phrase one step at a time, including tied notes.
- Turn the Amount knob to scroll through the sequence, or select a step manually for editing.
- Use Modulation tracks to capture the movements of up to three controls on specific steps.

If you want to try it now and read later, stop the sequence (if it's playing). Then press the Record button to enter step record mode.

### 8.3.8. The Modulation tracks

Sequencer* Rusty Organ   120.00	
1.Steps 1-32	5.Lfo3 Curve
2.Steps 33-64	6.Lfo3 Symmetry
3.Notes	7.Amount
4.Modulations	8.Erase Mod

Controller changes can be recorded for up to three parameters, live or in step record. Here's how it works:

- During real-time recording the sequence normally loops indefinitely, but when recording a Modulation track the record light turns off after one loop.
- When a control is moved during a record loop, Modulation track recording begins on that step (i.e., step N). When the record loop reaches step N-1, the record light turns off. This can be repeated for two other controls.
- Use [Assign 4] on the Sequencer home page to select the Modulations view. The names of the recorded controls appear in the display at Assign slots 5-7.
- To delete a Modulation track, hold [Assign 8] and press the Assign button that shows the name of the track to be deleted.
- While step-recording, move one of those three parameter controls to enter or change its value at the selected step.
- When the sequence is not playing, [Assign 8] "Toggle Mute" is active in Modulations view (even though you can't see it). Use this when you want to hear what the Modulation tracks are doing while holding a few notes.



For details about editing the contents of a Modulation track, see [Step record: Mods \[p.71\]](#).

When SEQ mode is selected in the SEQ-ARP section, pressing the round **Sequencer** button in the Matrix Panel will cycle through useful Sequencer displays.

- First press: Keyboard graphic showing what notes are played.
- Second press: Modulation and automation lanes.
- Third press: Step edit view for the current step.
- Fourth press: Returns to Sequencer home page.

## 8.4. Matrix Arpeggiator

This mode is a hybrid of the Sequencer and the Arpeggiator. Hold up to six notes, and out of those PolyBrute plays the ones you enable on each step, in a specific octave for each step, for up to 16 steps before repeating.

To enter the Matrix Arpeggiator, press the [SEQ] and [ARP] buttons at the same time. Both should stay lit up.

The arpeggio rhythm is shaped by enabling and disabling the steps in each column, which are then played back in order according to the Play Mode setting.

The following graphic shows how a monophonic pattern might look. Here are some things to know:

- Row A adds a slide to that step; Row B adds an accent to that step.
- Row C enables a step to play a note. This arpeggio has rests at steps 2, 6, and 7.
- Rows D-I represent held notes 1-6. If 5 notes are held, for example, row D does not affect the pattern.
- Row J shifts a step +1 octave; Row K means no shift; Row L shifts a step -1 octave.

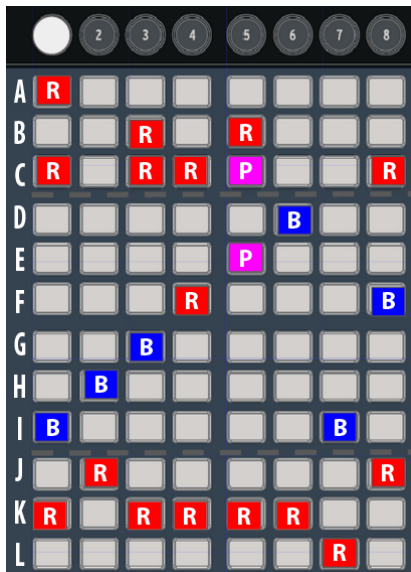

Color key: R = red, B = blue, P = purple

### 8.4.1. Matrix Arp home page

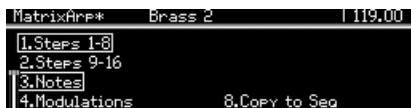

The home page provides viewing options and more:

- [Assign 1+2] switch between steps 1-8 and steps 9-16.
- [Assign 3+4] switch between Notes view and [Modulations view \[p.64\]](#).
- [Assign 8] activates [Copy to Seq \[p.56\]](#).



## 8.4.2. Polyphonic arpeggios

The Matrix Arpeggiator is polyphonic. Here are some things to know about that:

- Multiple cells can be enabled in each column.
- A long press on a cell will clear the others in the same column.
- Pressing and holding two cells from different columns draws a "monophonic" line between the two cells.

## 8.4.3. Approach notes

In Matrix Arpeggiator mode "chromatic approach" notes can be assigned:

- Lower approach note: If you turn the Amount knob counter-clockwise while pressing a button in the voice assign section, the button turns red instead of blue. This means the note is played one half step below the held note.
- Upper approach note: If you turn the Amount knob clockwise while pressing a button in the voice assign section, the button turns purple instead of blue. This means the note is played one half step above the held note.
- To restore the original pitch press the voice assign button twice. It turns blue again.

 If you hold the Matrix button for 1+ seconds before turning the Amount knob, the other cells in the same column will be cleared. You'll need to re-enable them if you want that step to be polyphonic.

## 8.4.4. Play Mode: Matrix Arp

Hold [Play Mode] and use [Assign 1-4] to select an option. These set the playback direction for the pattern.

- **Forward** plays the pattern from the first step to the last, then starts at the beginning again.
- **Pendulum** plays the pattern forward and then backward, repeating the first and last steps.
- **Random** can trigger any step inside the sequence length, even steps that contain no data.
- **Walk** moves according to probability, not chance. On each step there is a 50% chance that the next step will be the one to the right, a 25% chance the same step will repeat, and 25% chance that the *previous* step will play.

Press [Play Mode] repeatedly to step through the various options.

 All of the [Common features \[p.54\]](#) apply to Matrix Arpeggiator mode (Home page, Hold, Metro, Time Div, Swing, Rate, Gate, Tap), as do the features specific to Sequencer mode ([Play Mode \[p.62\]](#) and [Seq length \[p.62\]](#)).

## 8.5. Sequence Management

Seq Management	
1.Copy Current Seq	5.Erase Notes
2.Paste Seq	6.Erase Automation
3.Paste Seq + Autom	7.Transpose -1 st
4.Clear Current Seq	8.Transpose +1 st

Hold [Sequencer] to view the sequence editing features, then use [Assign 1-8] to select the desired option. These are described in the following sections.

### 8.5.1. Copy current sequence

Hold [Sequencer] and press [Assign 1] to copy the current sequence into a temporary buffer. You can then use the Paste Sequence feature to transfer the sequence to a different patch.

### 8.5.2. Paste sequence

Hold [Sequencer] and press [Assign 2] to paste some of the contents from the temporary buffer into the sequence memory of the current patch. This option only pastes the notes from the sequence, not the automation data. This will replace the note data of the current sequence with the contents of the temporary buffer.

### 8.5.3. Paste sequence and automation

Hold [Sequencer] and press [Assign 3] to paste the entire contents of the temporary buffer into the sequence memory of the current patch. This option pastes both the notes and the automation data from the sequence. This will replace all of the data of the current sequence with the contents of the temporary buffer.

### 8.5.4. Clear current sequence

Hold [Sequencer] and press [Assign 4] to clear the current sequence.

### 8.5.5. Erase notes

Hold [Sequencer] and press [Assign 5] to erase only the notes inside the current sequence. The Modulation tracks will not be affected.

### 8.5.6. Erase automation

Hold [Sequencer] and press [Assign 6] to erase only the Modulation tracks inside the current sequence. The note data will not be affected.

### 8.5.7. Transpose sequence

Hold [Sequencer] and press [Assign 7] or [Assign 8] to transpose all the notes from the sequence by -1 semitone or +1 semitone.

## 9. STEP RECORD / EDIT

### 9.1. What's the difference?

The terms are sometimes used interchangeably. Here's what they mean in PolyBrute:

- Step recording means **entering data**. It is more track-focused.
- Step editing means **editing an event** (i.e., a Step). The focus is one event at a time.

### 9.2. Overdub ON vs. Overdub OFF

On the Sequencer mode home page you can use [Assign 7] to toggle between Overdub ON and Overdub OFF. This setting does not affect the Modulation tracks. It is active in both Notes view and Modulations view (even when you can't see it).

- **Overdub OFF:** Step overdub OFF replaces all notes in the step, even if only one note is played.
- **Overdub ON:** Steps can overdub additional notes up to the maximum polyphony of 6 voices, and then no more notes can be added. You can delete individual notes in [Step Edit mode \[p.70\]](#).

### 9.3. Step Record

Step recording lets you edit a real-time recording, and also offers a different way to work with patterns. With it you are able to:

- Enter a phrase one step at a time, including tied notes.
- Capture the movements of up to three controls on the Modulation tracks.

To enter Step record mode, stop the pattern (if it's playing) and press the Record button. The pattern locates to step 1. Here's some of what you can do:

- Play one or more keys to enter a note or chord on step 1.
- Use the Amount knob to scroll to a different step. The purple step is the record cursor.
  - A red step has an active note or chord. That step plays when the cursor reaches it.
  - Dim red buttons are tied notes and do not trigger.
- Touch a Matrix button to select a step. A red step plays when selected.
  - To replace the note data of the selected red step, make sure that Overdub OFF is set, and play one or more keys.
- A dark step is silent (i.e., a rest) but may not be disabled. To be sure, exit Step record mode (press the Record button) and touch that Matrix button. If it turns red, it contains note data.
  - Back in Step record mode, select that dark step with the Amount knob or touch its Matrix button.
  - To enter note data to the selected dark step, play one or more keys. It becomes a red step.
- As needed, use [Assign 1+2] to switch between steps 1-32 and 33-64, and use [Assign 3-4] to switch between Notes view and [Modulations view \[p.71\]](#).



In Step record mode, holding a red button for about 1 second enters step edit mode. Press that button again to exit, or learn about it [here \[p.70\]](#).

### 9.3.1. Enter / edit one step

With Record On and the pattern not playing, your options include:

- Use [Assign 7] to select Overdub ON or Overdub OFF.
- Touch a red step to select it. You can also touch a Slide or Accent button.
- To enter or replace notes on the current step, play one or more keys.
- To enter or replace the notes of any step in the pattern, touch its step button to select it. Now play one or more keys.
- To edit the length of a step or replace individual notes within a chord, see the [Step Edit: Notes section \[p.70\]](#).
- To add or remove a slide or an accent at any step, press one of those buttons. A slide affects the transition *into* the current step. Glide time must be sufficient to hear the slide.
- Press [Assign 8] to erase the current step. It will take with it any tied steps.
- [Tap] can erase any step in the pattern. Select the step and press [Tap]; the step is erased and the cursor advances to the next step.

### 9.3.2. Enter / edit many steps

With Record On and the pattern not playing, your options include:

- Use [Assign 7] to select Overdub ON or Overdub OFF.
- Touch a red step. You can also touch a Slide or Accent button.
- To add or replace a series of notes, play the keys. As each note is played the cursor advances and selects the next step.
- Press [Tap] to enter a rest or erase the current step.
- To erase several steps in a row, touch the first step and press [Tap] repeatedly.



! When recording while a pattern is playing, holding [Tap] **erases the notes** and disables all events until [Tap] is released.

## 9.4. Step edit: Notes

Step 1*	Init					120.00
D3	E3	F3	G3	A3	B3	Note
38	57	79	63	45	34	Vel
0.5	0.5	0.5	0.5	0.5	0.5	Length
1	2	3	4	5	6	Dub OFF

Step editing lets you make precision edits to an individual event. You can enter step edit mode from Play mode (record off) or from Step record mode (record on). In this mode you are able to:

- Play one or more keys to enter note(s) or to replace existing notes.
- Delete / replace a note in the middle of a chord.
- Use the Amount knob to lengthen / shorten the step.
- Switch to Modulations view to edit the control movements for a specific step. See [Step record: Mods \[p.71\]](#).

Let's walk through the step editing procedures. You can do this whether the sequence is playing or not (you just won't see the cursor while it's playing).

To enter Step edit mode, hold a step button for about 1 second. (Slide or Accent buttons also can be used.) The Matrix buttons now show three different colors: The current step is red, nearby steps are purple, and blue shows the duration. Here you can add or delete notes to the step and change its duration.

### 9.4.1. Add / delete notes

Use the keyboard to add notes to the step. As notes are added the same number of Matrix buttons are lit red, and they stay red as long as the notes are held. The duration of a red button can be changed with the Amount knob. When a note is released its Matrix button turns blue, and its length can't be changed unless all notes are released (or the same note is played again).

The next part of the process is a bit different depending on the [Overdub ON/OFF setting \[p.68\]](#).

#### 9.4.1.1. Record mode: Overdub OFF

If you play a chord, release all notes, and then play another note, the first notes are overwritten by the new note. As long as a note is held down you can continue to add more notes, up to the maximum of 6.

#### 9.4.1.2. Record mode: Overdub ON

You can enter two notes on a step, for example, then lift your fingers and add up to four more notes without overwriting the first two. Pressing a note which is already in the step will light it in red again, and then its length can be changed with the Amount knob.

## 9.4.2. Change the duration

After all notes are released, the corresponding Matrix buttons turn blue. There are several ways to change the duration of the notes.

### 9.4.2.1. All notes

With all notes released, turn the Amount knob clockwise to lengthen all of the notes in the step. Those notes are now tied into the following steps. The blue LEDs to the right indicate the length of the tied notes. This is also visible in playback mode.

Now turn the Amount knob counter-clockwise; fewer blue LEDs means the notes are shorter. If a note is extra long you may need to keep turning the knob before anything changes.

### 9.4.2.2. One note

Press and hold a blue button, then turn the Amount knob to edit the length of a single note in a chord.

### 9.4.2.3. Proportional changes

It's possible to add a note, extend it with the Amount knob, then add another note, etc., and extend them proportionately.

### 9.4.2.4. Remove notes

Press the left-most blue button of a row to remove that note from the chord.

## 9.4.3. Select a purple step

Touch one of the purple buttons: it turns red to show it is the current step. Add one or more notes and adjust their duration, or select another purple button instead.

## 9.4.4. Exit step edit

When you're done, you can press the red step or the Record button to exit step record. This returns you to the home page. To confirm the changes, re-enter step record and press that red step to hear it.

## 9.5. Step record: Mods

The movements of up to three controls can be recorded on the Modulation tracks, live or in step mode. The controller data can be added or edited on each step. Live recording is covered [here \[p.64\]](#); in this section the focus is Step recording. For this example, start with a sequence that has no Modulation tracks recorded.

First, stop the pattern (if it's playing), then press the Record button to enter step record mode. Use [Assign 4] to select Modulation view. You can switch back to Notes view using [Assign 3] at any time.

The Modulation tracks are in sets of three, and are shown in rows A-C and rows D-F but also in Rows G-I for the steps 17 to 24, and J-L for the steps 25 to 32. Modulation track steps that contain a value are blue. Existing Modulation tracks are named in the display as Assign buttons 5-7.

Up to three parameters can be recorded - there are three Modulation tracks. Here's how it works:

- When the first parameter is touched, a step button in the first row is lit blue.
- When another parameter is touched, in this or another step, a step button in the second row is lit blue.
- Once all three parameters are assigned to Modulation tracks, you won't be able to create more Modulation tracks. Moving another control will not change the current step. To delete one of the Modulation tracks, read [this section \[p.72\]](#).
- Turning a parameter knob that has been recorded to a Modulation track triggers the notes that exist at the current step. The trigger can only occur once every 0.7s.

### 9.5.1. Enter / edit one mod step

Move one of the three chosen controls to edit its value at that step. If a mod event did not exist for that control on that step, a button on its Modulation track turns blue. You can toggle individual Modulation track steps on and off by pressing a specific blue button.

 **i**: [Tap] erase doesn't work with Modulation track steps.

### 9.5.2. Enter / edit many mods

You can record Modulation tracks while the pattern is looping, even inside the Modulations view. For details, see the [Modulation track section \[p.64\]](#).

### 9.5.3. Delete a Modulation track

To delete a Modulation track, hold [Assign 8] and press the Assign button that shows the name of the track to be deleted. It will disappear from the list in the display. Here are two more things to know about the process:

- Deleting a Modulation track leaves that step row empty, but it does not reorganize the rows.
- The next time a new parameter is recorded, the first empty Modulation track is filled.

 **i**: With Record Off and the pattern not playing, the assigned Modulation track parameters can be edited without affecting the Modulation tracks.

### 10.1. What is Morph Mode?

Every PolyBrute preset is made up of two sounds (A and B) that are available at the same time. Both the Morph knob and Morphée controller are able to crossfade seamlessly between the two sounds, each of which can have entirely different settings for the filters, envelopes, and LFOs, to name a few things. Morphing is applied to these parameters as if you were moving all the controls at once. And you are...but you're doing it with a single control.

No other analog synthesizer has ever had this kind of power: two full-fledged sounds in a single patch, with gobs of parameters on either side. It's tempting to think of them as layers, except that PolyBrute also has a Layer mode for stacking voices on top of each other, in addition to the morph capabilities.

#### 10.1.1. Morph vs. crossfade

Morph is not a crossfade; it's an infinite number of compromises from one setting to the next. Parameter values change gradually from one state to another state, hitting every intermediate value between the two.

To illustrate the concept, we invite you to try this example:

1. Initialize the patch and turn the Morph knob to its halfway point, so you can modify sounds A and B equally.
2. In the Mixer section, set VCO 1 level to zero and VCO 2 level to maximum.
3. Set the Morph knob all the way to B and set VCO 2 pitch to maximum (+7 semitones).
4. Now play a note and turn the Morph knob from A to B: the pitch changes gradually between the two.

This is what morphing the two values for VCO 2 *should* do; it's not at all the way crossfading them would work. To hear both pitches at the same time during a crossfade would require four VCOs per voice, not two, so that both VCOs on either side could retain their pitch settings and fade in/out as the knob is turned.

By the way, it's a lot of fun to watch this happen when using the PolyBrute Connect software. Just a little hint there...please go get it if you don't already have it!

There are a few [parameters that can't morph \[p.78\]](#) due to their very nature: these are mutually exclusive, contradictory, or binary/trinary settings between which no compromise is possible.

One more thing: sounds A and B share the same set of 32 Mod Matrix routes and 64 mod connections. But that's usually more than enough! All told, a PolyBrute patch is an animated, lively thing.



## 10.2. The Morph knob

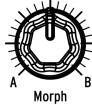

This unassuming control is at the heart of the morphing feature. At its full counter-clockwise position it allows only sound A to pass; at its full clockwise position it allows only sound B to pass. It is continuously variable between the two settings, so an infinite number of blends is possible between sounds A and B.

The position of the Morph knob is stored with each preset. This becomes the starting point for the modulations affecting both sounds.

The position of the Morph knob also defines the way A and B are modified when a knob or fader is moved: at its full counter-clockwise position only the sound A parameter will be modified; the more it is turned clockwise, the more the sound B parameter will be modified and the less the sound A parameter will be modified; at its full clockwise position only the sound B parameter will be modified.

## 10.3. Morphing with Morphée

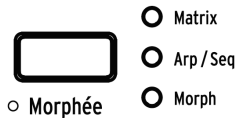

When the Morphée button is set to "Morph", the X axis will morph the "Level" parameters (such as VCF Levels, or VCO waveform mix etc.) while the Y axis will morph the "Pitch" parameters (such as VCO pitch or VCF cutoff)

When Morphée is swept to bottom left you hear sound A; when it is swept to upper right you hear sound B.

In this mode, there is a strong interaction between the Morph knob and Morphée, as moving the Morph knob will take over both X and Y morph axes. However, while the Morph knob defines the way A and B sounds are modified when a knob or a fader is moved (see 10.2), Morphée does not affect this behaviour. This means that if the morph knob is at its full counter-clockwise position and Morphée is swept to upper right, you will hear sound B but a knob or fader movement will only affect sound A.

For more information about the Morphée controller, read [this section \[p.37\]](#) in the Performance controls chapter.

## 10.4. Morph and mod routes

As mentioned earlier, sounds A and B share the same set of 32 Mod Matrix routes (and 64 mod connections). That means, for example, that for Mod page 1, route A 1, the selections for the source and destination need to be the same. But the settings for the source can be completely different for sound A and for sound B!

Here's a quick example:

1. Initialize the patch and turn the Morph knob to A.
2. Enter Mods mode, set up a mod route from LFO 1 to Pitch Global, and give it a positive amount.
3. Set the LFO 1 waveform and speed to something obvious like a slow downward sawtooth.
4. Turn the Morph knob to B.
5. Give the LFO 1 to Pitch Global a positive amount and set the LFO 1 speed to something different.
6. Press the [Morph] button (under the Amount knob) to enter Morph mode.
7. Select Edit B with [Assign 2]. Now two mode buttons are lit (Mods and Morph).
8. You can now set LFO 1 waveform to something different.
9. Now play a note and turn the Morph knob from A to B: the LFO changes gradually between the two.

As you can see, there's a lot of potential even when sounds A and B are sharing the same modulation source.

## 10.5. Morphing sounds

The top level of Morph mode has eight options: three for sound editing, and five utilities.



### 10.5.1. Editing sounds A and B

The Edit A / Edit B modes allow you to change settings that would otherwise set sounds A and B to the same value. For example, here's what happens when changing the VCO filter routing at the Preset level.

- [Initialize the patch \[p.15\]](#).
- Press [Presets] to reach the top level, if you're not already there.
- In the Mixer section, the routing LED shows that VCO 1 is routed to the Ladder filter.
- Turn the Morph knob from A to B: the filter routing does not change.
- Change the filter routing to the Steiner filter and turn the Morph knob again: the filter routing does not change.

To route VCO 1 to different filters for sounds A and B:

1. Enter Morph mode
2. Use [Assign 2] to enter Edit B
3. Press the filter routing button to route VCO 1 to the Ladder filter.

Now press [Presets] and turn the Morph knob. The VCO 1 filter routing LEDs will morph from Steiner to Ladder routing, with both lit when the Morph knob is at its midpoint. This example works on any patch.

#### 10.5.1.1. Edit A

Use [Assign 1] to access and change the settings for sound A. Inside this mode you can:

- Change the values for any voice engine parameter [except as noted here \[p.78\]](#).
- Set the levels that sound A will use for the shared mod routes. The Mods button will light in red and you'll be taken to the Mod Matrix. Edit the level to the desired value.

#### 10.5.1.2. Edit B

Use [Assign 2] to access and change the settings for sound B. Inside this mode you can:

- Change the values for any voice engine parameter [except as noted here \[p.78\]](#).
- Set the levels that sound B will use for the shared mod routes. The Mods button will light in red and you'll be taken to the Mod Matrix. Edit the level to the desired value.

#### 10.5.1.3. Edit A+B

Use [Assign 3] when you want the parameters for sound A and B to have the same value. Inside this mode you can:

- Change the values for any voice engine parameter [except as noted here \[p.78\]](#).
- Set the levels that sounds A and B will use for the shared mod routes. The mod source settings can still be different; just the mod amount and polarity will be the same. The Mods button will light in red and you'll be taken to the Mod Matrix. Edit the level to the desired value.



When In *Edit A* or *Edit B* you can access independent settings using the **Settings** button or Settings shortcuts. For example, you can cause parts A and B to have different pitch-bend ranges.

## 10.5.2. Morph utilities

### 10.5.2.1. Pick B

This option allows you to copy sound A or B from any preset into the edit buffer of the patch you're creating. After selecting the Pick B option, use [Assign 1-8] and the Matrix buttons to select the source patch for sound B.

After selecting the source patch, the display shows that sound A from the selected patch has been copied into sound B of the patch being edited.

```
Pick B
A : Init
B : (A) Ephemere
```

Push the Matrix button for the source patch again and the display changes to show that sound B from the selected patch has been copied into sound B of the patch being edited.

```
Pick B
A : Init
B : (B) Ephemere
```

### 10.5.2.2. Copy A->B

When creating a patch you might want to morph between two sounds that are similar in some ways and drastically different in only a few ways. Use this option to copy sound A into sound B, and then edit each sound as you see fit.

### 10.5.2.3. Current to A

If the current position of the Morph knob gives you exactly the sound you want for sound A, you can transfer that to sound A and then focus on sound B.

### 10.5.2.4. Current to B

Likewise, if the current position of the Morph knob gives you exactly the sound you want for sound B, you can transfer that to sound B and then focus on sound A.

### 10.5.2.5. Swap A/B

Here's a use case for this feature: Let's say you like what the Pick B function brought into the patch but you're not so thrilled about sound A now. Swap A and B; now your sound B resides in sound A. Now you can search for another complementary sound using the Pick B function again.

## 10.6. What can morph?

Nearly every PolyBrute parameter can morph between its settings for sounds A and B. These include the filters, the VCOs, the Envelopes, and the LFOs. Even some unusual parameters like Sync and Noise Colour can be morphed.

Set A/B with Morph knob [1]	Use Edit A / Edit B [2]	Can't morph [3]
Front panel knobs, sliders (Voice engine only)	Mixer destinations (filter routing)	Polyphony settings: Poly / Mono / Uni
Matrix modulation amounts	LFO 1 / LFO 2 waveforms	Timbrality settings: Single / Layer / Split
	LFO 1 / LFO 2 Retrig modes	Wheel assignment: Matrix / Cutoff / Vibrato / LFO1 Amp
	LFO 1-3 [Sync] on/off	Octave button settings
	LFO 3 [Retrig] on/off	Glide settings: Time/Rate, Continuous/Chromatic
	LFO 3 [Single] on/off	Matrix destinations
	LFO 3 [x LFO 1] on/off	FX routing: Insert / Send / Bypass
	Voice parameters accessed via [Setting] + [knob/fader]	Effect types
	Voice settings accessed with a long button press	Sequences, Seq/Arp settings
		Motion recorder
		Ribbon settings
		Other controller settings (Exp 1/2, etc.)

1. These values can be edited from the front panel. Set the Morph knob to A or B as needed.
2. These must be set inside Edit A and Edit B in order for their values to be different.
3. These parameters can't morph because they affect sounds A and B equally within each patch.

### 10.6.1. Mixer destinations [filter routing]

As mixer destinations do morph (use Edit A and Edit B for setting different routings between A and B, see [Editing sounds A and B \[p.75\]](#)), you can actually set percentage amounts of oscillator output passing to each of the filters.

To set VCO1 25% into Steiner and 75% into Ladder:

1. Follow the instructions from 10.5.1 to set VCO1 to Steiner in sound A, and to Ladder in sound B.
2. Turn the Morph knob to 75% : VCO1 is routed 25% into Steiner and 75% into Ladder. The mixer LEDs reflect this state, as the VCO1 to Steiner LED is dimmed (25%) and the VCO1 to Ladder is more lit (75%).
3. You can even use the [Current to A utility \[p.77\]](#) so that mixing is applied to the A sound.

### 10.6.2. LFO 1 / LFO 2 waveforms

Similarly to the Mixer destinations (see section above), you can set LFO1 / LFO2 to output a mix of their waveforms by using different waveforms between the A and B sound, then using the Morph knob and the Current to A or Current to B utilities. The LFO waveform LEDs also reflect this state.

### 10.6.3. LFO 1-3 Retrigger modes

Similarly to the Mixer destinations (see section 10.6.1), you can set LFO1 / LFO2 to a percentage amount of Retrigger modes (i.e. a state in between Mono, Poly Free and Poly Retrigger modes). The LFO 1 / LFO 2 Mono Retrigger and LFO3 Retrigger parameters are also continuous.

Morphing between a retriggered and a free LFO works as follows:

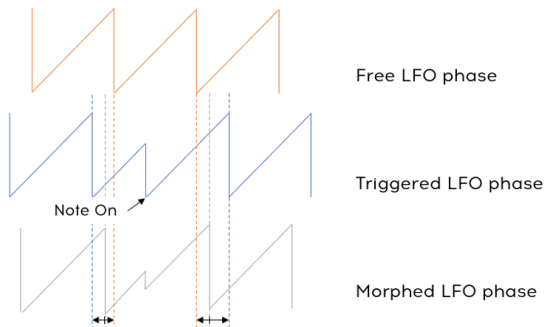

### 10.6.4. LFO 1-3 Sync

Similarly to the [Mixer destinations \[p.78\]](#), you can set LFO 1-3 to a percentage amount of Sync modes (i.e. a state in between Synced and Unsynced).

From 0% to 50% Sync, the LFO rate will continuously morph between its Unsynced value and its Synced value. The LFO phase remains free. Once the "Sync" parameter reaches 50%, the LFO phase will smoothly lock into sync.

The Sync options are Binary, Triplet, and Dotted (see [LFO Sync division \[p.29\]](#)). These can also morph, but not continuously. When the Sync Division parameter is between 0 and 33% the division is Binary, from 33% to 66% it is Triplet, and from 66% to 100% it is Dotted.

### 10.6.5. LFO 3 Single

Similarly to the [Mixer destinations \[p.78\]](#), you can set the LFO 3 Single parameter to other values than 0% or 100%.

With the Single parameter from 100% to 1%, the number of LFO cycle repeats changes linearly from 1 to 32. At 0% Single, the number of LFO cycle repeats is infinite.

The chart below shows the interaction of the Retrig and Single parameters.

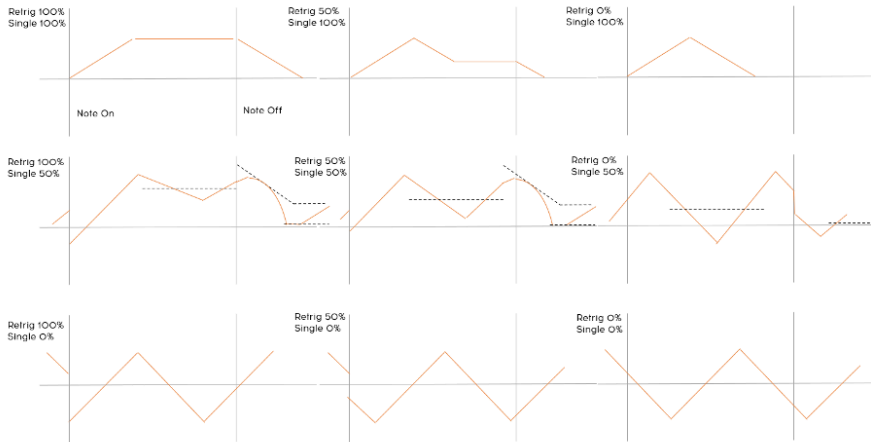

### 10.6.6. LFO 3 XLFO 1

Similarly to the [Mixer destinations \[p.78\]](#), you can set the LFO 3 XLFO1 parameter to other values than 0% or 100%.

LFO 3 XLFO 1 has both a modulation and a triggering action (see [section 4.5.2 \[p.28\]](#)), and both have a continuous behaviour.

With XLFO 1 modulation from 0% to 100%, the output of LFO3 will be modulated with a cross-fade between 1 (i.e. no modulation) and the value of LFO1 (i.e. full LFO1 modulation). With XLFO 1 trigger from 0% to 99%, the LFO3 will be retriggered by LFO1 from 0 to 32 times in a row. With XLFO 1 trigger at 100%, the LFO3 will be continuously retriggered by LFO1.

## 11. THE EFFECTS

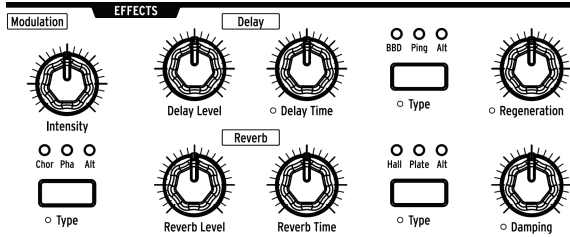

PolyBrute features a digital Effects section with all the classic effect types:

- Modulation: Chorus, Phaser, Flanger, Ring Mod, Ensemble, Distortions, and lots of other interesting pitch-based effects.
- Delay: everything from quick slapback, ping pong, and stereo delays are at your disposal.
- Reverb: vintage effects like Bright Plate are available, plus lush options like shimmering effect, etc.

Note that all of the Effects section knobs can be modulation destinations in the Matrix.

### 11.1. FX routing

**Insert** routes the entire output signal through the effects in this order: Modulation > Delay > Reverb.

**Send** uses the Delay and Reverb in a bus configuration that preserves the analog signal path. The Modulation effect is always in Insert mode.

**Bypass** lets you silence all three effect units at the same time while leaving their output levels intact for later recall.

Note that when the signal is dry (effect levels at zero) the signal path is pure analog, even in Insert mode.

#### 11.1.1. Mod FX Insert Routing

Pressing [Settings] and [FX] Routing in Insert or Bypass mode lets you place the Modulation FX at different points in the signal chain. Options include:

- **Pre Delay:** Mod > Delay > Reverb (this is the default)
- **Pre Reverb:** Delay > Mod > Reverb
- **Post Reverb:** Delay > Reverb > Mod

#### 11.1.2. Mod FX Send Routing

Pressing [Settings] and [FX] Routing in Send mode lets you place the Modulation FX at different points in the send architecture. Options include:

- **Pre Send:** Mod FX is placed before the Delay and Reverb sends
- **Send Wet:** Mod FX is placed only on the wet returns



- **Post Return:** Mod FX is placed on the wet/dry mix of the returns

Note that in the latter two settings, the Mod FX is placed on a mix of the delay and reverb, not one or the other.

## 11.2. Modulation Effects

**Intensity** controls the depth of the selected Modulation effect.

**Modulation Type** selects one of these options:

- **Chor** (Chorus) is an LFO-modulated delay, in the vicinity of 5 to 50ms. It's a rich, thickening sound.
- **Pha** (Phaser) creates several versions of the incoming signal. The phase of each version is altered by an all-pass filter, and the affected signals are then combined with the original. The result is a lush modulation with a comb filtering effect, as heard on many classic electric piano and string machine tracks.
- **Alt** (Alternate): Hold [Settings] and press [Modulation Type] to view the Alternate Type. These eight variations are the ones that can be selected for (and saved with) the patch you're creating:
  - Flanger
  - Soft Flanger
  - Phase Flanger
  - Phaser 12p
  - RingMod
  - Ensemble

## 11.3. Distortion Effects

If you press the Modulation Effects [Type] button repeatedly until all three LEDs light up, you can apply a Distortion Effect rather than an Alt Modulation. The display shows your choices:

- Subtle Tape
- Classic Disto
- Soft Clip
- Worn Out Tape
- Germanium
- BitCrusher
- DownSampler

## 11.4. EQ

The Modulation section contains a hidden EQ, which may be used alongside the modulation effects at the same time. It is accessed by holding [Settings] and turning the [Intensity] knob. This will bring up a menu with eight options to impart an EQ curve to the PolyBrute's sound:

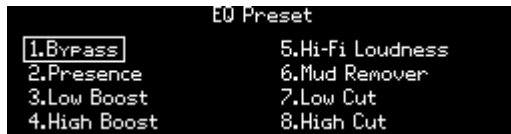

- **Bypass:** No EQ.
- **Presence:** Midrange boost.
- **Low boost:** Boost of bass frequencies.
- **High boost:** Boost of treble frequencies.
- **Hi-Fi Loudness:** Emulation of loudness setting on home hi-fi gear. Bass frequencies are boosted.
- **Mud Remover:** Roll-off of very low frequencies to reduce rumble.
- **Low Cut:** Similar to Mud Remover but with a higher roll-off frequency.
- **High Cut:** Roll-off of very high frequencies to reduce sibilance and "sizzle."

## 11.5. Delay

### 11.5.1. Delay controls

**Delay Level** controls the output of the selected Delay effect.

**Delay Time** adjusts the time between each reiteration of the Delay.

**Delay Type** selects one of these options:

- **BBD** (Bucket-Brigade Device) emulates an analog delay that quickly degrades the effect output.
- **Ping** (Ping-Pong) bounces back and forth in the stereo field.
- **Alt** (Alternate): Hold [Settings] and press [Delay Type] to view the Delay Custom Type. These seven variations are the ones that can be selected for (and saved with) the patch you're creating:
  - Stereo Delay
  - Long Delay
  - BBD PingPong
  - Karplus
  - Stereo Spread
  - Parallel
  - BBD Spread

**Regeneration** controls the number of reiterations the delay will produce.

### 11.5.2. Delay sync options

Hold [Settings] and turn Delay Time to view the "Delay Time Mode" menu. Use [Assign 1-4] to specify whether the delay is synced to the master clock or not, and which time division it uses when synced.

- **Hertz:** not synced
- **Binary, Triplet, or Dotted:** synced

When one of the synced options is selected, the delay time division is displayed as the Delay Time knob is turned.

### 11.5.3. Delay filter options

Hold [Settings] and turn Regeneration to view the “Delay Filters” menu. Highpass and Lowpass options are available, and one selection can be made from each column. Use [Assign 1-4] to select the HP option, and use [Assign 5-8] to select the LP option.



## 11.6. Reverb

**Reverb Level** controls the output of the selected Reverb effect.

**Reverb Time** adjusts the time it takes for the Reverb to decay.

**Reverb Type** selects one of these options:

- **Hall** recreates the reflections of a fairly large acoustic space.
- **Plate** simulates the famous reverberation units found in some famous studios.
- **Alt (Alternate)**: Hold [Settings] and press [Reverb Type] to view the Reverb Custom Type. These five variations are the ones that can be selected for (and saved with) the patch you're creating:
  - Bright Plate
  - Room
  - Dreamy
  - Springy
  - Delayed Plate

**Damping** controls how quickly the higher frequencies decay. A gradual roll-off is heard from high to mid, with the low frequencies the last to disappear.

### 11.6.1. Reverb filter options

Hold [Settings] and turn Damping to view the “Reverb HP Filter” menu. Use [Assign 1-4] to select the HP filter cutoff: Bypass, Low, Mid, or High.

## 11.7. Effects preset shortcut

The Modulation, Delay, and Reverb effects all feature a shortcut to bring up their respective Alternate presets. Simply hold the [Type] button in any section to bring up a menu of that section's Alt presets.

## 12. SETTINGS

Press [Settings] to access the Settings pages. They are divided into two main categories: Preset and Global. We'll assume in this chapter that you know to use [Assign 1-8] to select the options on each page.

Preset	Global
1.Synth Voice	5.Sync
2.Out Section	6.Keyboard
3.Expression Control	7.MIDI
4.Preset Info	8.Misc

### 12.1. Settings overview

#### 12.1.1. Preset settings

Synth Voice	Out Section	Expression Control	Preset Info
VCO	Preset Volume	Bend Range	Init
Envelopes	Stereo Modes	Vibrato Options	Details
LFO	EQ Preset	Duo Control	Generate
Voicing	Modulation Settings	Morphee Modes	Edit Sound Designer
	Delay Settings	Ribbon Modes	
	Reverb Settings	Exp1 Settings	
		Exp2 Settings	
		Hold Settings	

#### 12.1.2. Preset > Voice settings

VCO	Envelopes	LFO	Voicing
VCO1 Tuning	VCF Velo Mode	LFO1 Global Retrigger	Poly
VCO1 Tune Mod	VCF Env Curves	LFO2 Global Retrigger	Uni/Mono
VCO2 Tuning	VCA Velo Mode	LFO3 Polarity	Poly Lower
VCO2 Tune Mod	VCA Env Curves	LFO3 Curve	Uni/Mono Lower
Metalizer Mode	MOD Env Loop Mode	LFO1 Sync Division	Layer Mode
Sub Level Mode	MOD Env Curves	LFO2 Sync Division	Unison Voice Count
Morph Pitch Quantize	ALL Env Reset	LFO3 Sync Division	Unison Detune
Glide Settings		Voices Mod Source	Analog Accuracy

### 12.1.3. Global settings

Sync	Keyboard	MIDI	Misc
Source	Curves	Channels	Compare
Clock	Aft Sensitivity	Output Dest	Factory Reset
Metronome	Aft Filter	Input Src	Voice Auto-Tuning
Tempo Load	Pedals	Arp/Seq MIDI Out	Ctrl Calibration
Clock Send	Knob Catch	Local Control	FW Version
Transport Send		Program Change	LED Brightness
		Enable CC on Knobs	Sleep Time

## 12.2. Preset>Voice

The Settings / Voice category has four main areas: VCO, Envelopes, LFO, and Allocation.

```
Settings/Synth Voice
1.VCO
2.Envelopes
3.LFO
4.Voicing
```

### 12.2.1. Synth Voice>VCO

```
Settings/Synth Voice/VCO
1.VCO1 Tuning      5.Metalizer Mode
2.VCO1 Tune Mod   6.Sub Level Mode
3.VCO2 Tuning     7.Morph Pitch Quantize
4.VCO2 Tune Mod   8.Glide Settings
```

Use [Assign 1-8] to choose the item to configure.

#### 12.2.1.1. VCO1 Tuning

This let you tune the VCO1 in semitones or octaves.

```
Settings/Synth Voice/VCO/VCO1 Tuning
1.Knob : 1 Semitone      5.Octave : -2
2.Knob : 7 Semitones    6.Octave : -1
3.Knob : 12 Semitones   7.Octave : 0
4.Knob : 24 Semitones   8.Octave : +1
```

- Use [Assign 1-4] to change the tuning range of the *Tune* knob in semitones.
- Use [Assign 5-8] to apply an octave offset to your VCO.

### 12.2.1.2. VCO1 Tune modulation

These define the response when VCO 1 is a mod destination. It does not affect the VCO 1 Tune knob.

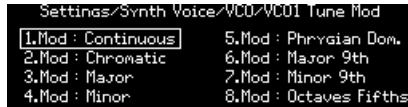

- Use [Assign 1-2] to select Continuous (smooth) or Chromatic.
- [Assign 3-8] select preset scales the VCO will follow when modulated.

### 12.2.1.3. VCO2 Tuning

This let you tune the VCO2 in semitones or octaves.

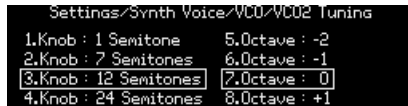

- Use [Assign 1-4] to change the tuning range of the *Tune* knob in semitones.
- Use [Assign 5-8] to apply an octave offset to your VCO.

### 12.2.1.4. VCO2 Tune modulation

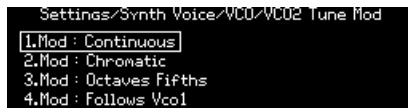

- [Assign 1-4] define how VCO 2 responds when it is a mod source destination.

### 12.2.1.5. Metalizer mode

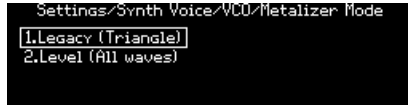

- **Legacy** is how the Metalizer works in all prior Brutes: only the triangle wave is folded.
- **Level** processes all VCO 1 waveforms.

For the engineers among you, here's a diagram of the two modes.

Tri: [(Tri  $\times$ F Metal Out)  $\times$ F Saw]  $\times$ F Sqr

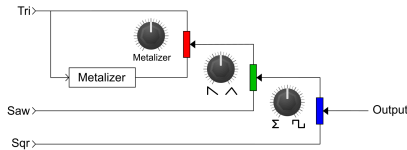

All : [(Tri  $\times$ F Saw)  $\times$ F Sqr] + Metal

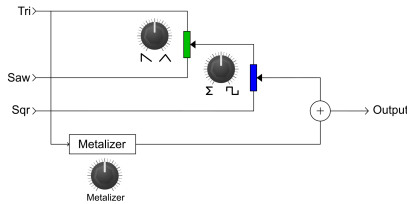

### 12.2.1.6. Sub Level Mode

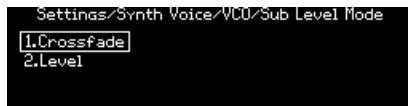

- Crossfade is the behaviour described in the Sub section.
- Level is a mode where only the sub level is affected by the knob ; the VCO 2 waveform mix remains unaffected

### 12.2.1.7. Morph pitch quantize

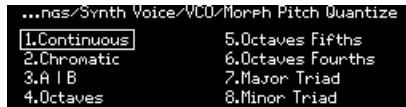

This affects how the VCO 1 & 2 Tune parameters change between their settings for sounds A and B as the Morph knob is turned. Note that when Vco2 Tune range is inferior than 12 semitones, it will always morph continuously

- **Continuous:** Smooth transition of VCO 1 & 2 Tune between sounds A and B.
- **Chromatic:** VCO 1 & 2 Tune changes in semitones between sounds A and B.
- **A | B:** When the Morph knob is between A and halfway, VCO 1 gives the A setting. When the knob is between halfway and B, VCO 1 gives the B setting.
- **Octaves:** VCO 1 jumps in octaves between sounds A and B.
- **Octaves Fifths:** VCO 1 jumps in fifths and octaves between sounds A and B.
- **Octaves Fourths:** VCO Tune parameter jumps in fourths and octaves between sounds A and B.
- **Major Triad:** VCO 1 transitions between sounds A and B with a major triad (root, major 3rd, 5th, octave)
- **Minor Triad:** VCO 1 transitions between sounds A and B with a minor triad (root, minor 3rd, 5th, octave)

### 12.2.1.8. Glide Settings

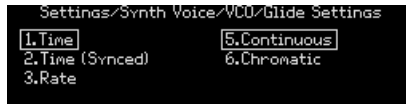

Use [Assign 1-3] to set the Glide mode:

- **Time** glides between any 2 notes in the same amount of time, no matter how far apart they are.
- **Time (Synced)** is similar, but the glide time syncs to the master clock. As the Glide knob is turned, time divisions are displayed, indicating rhythmic values.
- **Rate** links the glide speed to intervals, so the pitch takes 12 times longer to cover an octave than it does to cover a half-step.

Use [Assign 5-6] to specify whether the glide will be smooth or follow the chromatic scale.

- **Continuous:** Glide smoothly changes pitches with no "steps" between notes.
- **Chromatic:** Glide changes pitches in chromatic steps along the 12-note scale, like a glissando.



## 12.2.2. Synth Voice>Envelopes

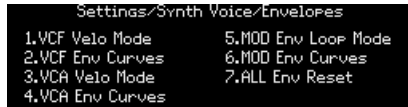

The VCF and VCA have identical velocity and envelope modes, so they are described together.

### 12.2.2.1. VCF/VCA velo mode

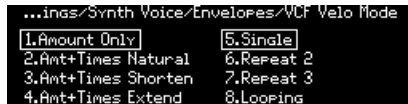

- **Amount Only** provides the normal response. With the **Amount+ Times** modes the velocity affects the Attack, Decay and Release Times. **Amt+Time Natural** shortens the Attack Time and extends the Decay and Release Times with higher velocities, while **Amt+Time Shorten** shortens all Times and **Amt+Time Extend** extends all Times.
- **Single** runs the envelope once. The **Repeat** options run the envelope 2 or 3 times. **Looping** runs the envelope indefinitely. When Sustain is at a non-zero value, the Repeats and Loops include the Release stage.

### 12.2.2.2. VCF/VCA/MOD env curves

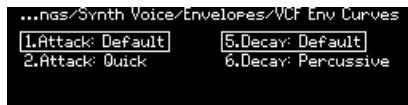

- Use [Assign 1-2] to select the Attack curve.
- Use [Assign 5-6] to select the shared curve for the Decay and Release stages.

### 12.2.2.3. MOD env loop mode



- Use [Assign 1-4] to select the loop mode for the MOD envelope.
- **Single** runs the envelope once. The **Repeat** options run the envelope 2 or 3 times. **Looping** runs the envelope indefinitely. When Sustain is at a non-zero value, the Repeats and Loops include the Release stage.

#### 12.2.2.4. ALL Env Reset

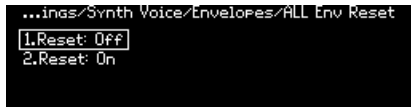

- With **Reset: Off**, the envelope will start the Attack phase from its current amplitude when a voice is retriggered.
- With **Reset: On**, the envelope returns to 0 and plays the entire Attack phase when a voice is retriggered.

#### 12.2.3. Synth Voice>LFO

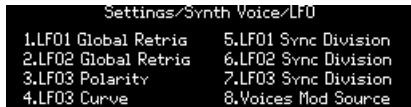

LFO 1 and LFO 2 have identical features, so they are described together. The Sync Division options for all three LFOs are identical, so they are described together. LFO 3 has a Retrig switch so its polarity options are described in a separate section.

##### 12.2.3.1. LFO1/LFO2 global retrigger

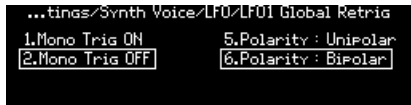

- An LFO set to Mono mode is shared by all voices. Mono Trig On/Off controls if the mono LFO will retrigger when a new note is played. When Mono Trig = ON, the mono LFO will retrigger; When Mono Trig = OFF, the mono LFO will *not* retrigger.
- Use [Assign 5-6] to choose the [polarity option \[p.28\]](#) for the LFO.

##### 12.2.3.2. LFO3 polarity

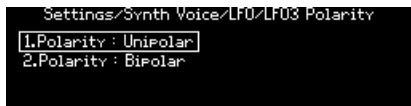

- Use [Assign 5-6] to choose the [polarity option \[p.28\]](#) for LFO 3.

### 12.2.3.3. LFO3 curve

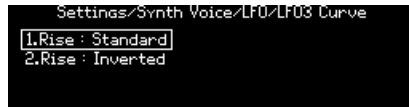

This setting allows you to invert the shape of the curve of LFO3. It may also be accessed by holding **Settings** and wiggling the Curve knob in LFO3.

- **Rise: Standard:** LFO performs a standard rise.
- **Rise: Inverted:** LFO performs an inverted rise.

This setting only affects the rising part of the curve; the falling part is left untouched. The Inverted option thus makes it possible to have an exponential rise and a logarithmic fall.

### 12.2.3.4. LFO1-3 sync division

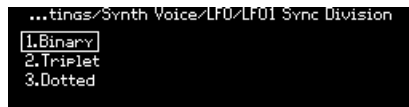

The Sync Division settings are the same for all three LFOs. The [Sync] button must be active for an LFO or this setting will make no difference.

### 12.2.3.5. Voices Mod Source

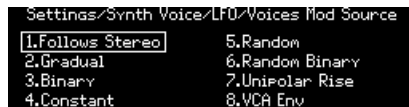

If you don't know about Voices source, you can first check out [this section \[p.53\]](#).

There are eight settings for the Voices source using [Assign 1-8].

## 12.2.4. Synth Voice>Voicing

Settings/Synth Voice/Voicing	
1.Poly	5.Layer Mode
2.Uni/Mono	6.Unison Voice Count
3.Poly Lower	7.Unison Detune
4.Uni/Mono Lower	8.Analog Accuracy

Use [Assign 1-8] to define the voice allocation for various combinations of [Polyphony] and [Timbrality].

### 12.2.4.1. Poly

#### Upper Zone

The following settings are available for polyphonic voice allocation on the Upper zone. [Assign 1-4] provide options for the order in which new voices are triggered.

Settings/Synth Voice/Voicing/Poly	
1.Poly Cycle	5.Steal Oldest
2.Poly Reset	6.Steal Lowest
3.Poly Unison	7.Steal None
4.Poly Reassign	

- **Poly Cycle** assigns a played note to the next available higher-numbered voice.
- **Poly Reset** starts with the first available voice every time a note is played.
- **Poly Unison** plays the first note using voice 1, stacks voices 2-6 on the second note played, leaves voice 2 on note 2 and stacks voices 3-6 on the third note played, etc.
- **Poly Reassign** will steal a voice with the same pitch, even if other voices are available. This is similar to the behavior of a piano, for example.

[Assign 5-7] define the order in which voices are stolen when polyphony is exceeded.

- **Steal Oldest** reallocates the first note that was played.
- **Steal Lowest** reallocates the note played with the lowest velocity in the chord.
- **Steal None** prevents any voices from being stolen.

#### Lower Zone

For the Lower zone, settings are only active when [Timbrality] is set to Split. Available settings are a subset of those for the Upper zone. These are:

- **Poly Cycle**
- **Poly Reset**
- **Poly Unison**
- **Poly Reassign**

In other words, the voice stealing options accessed by [Assign 5-7] are only available for the Upper zone.

#### 12.2.4.2. Uni/mono upper/lower

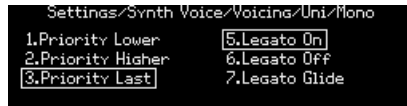

These settings are the same for the upper and lower zones so they are described together. They define how PolyBrute behaves when the zone [Polyphony] setting is Unison or Mono. Note that the Lower settings are only active when [Timbrality] is set to Split.

- [Assign 1-3] define whether the current note will change to a new note in response to a lower note, a higher note, or the most recently played note (Priority: Last). In the latter case, the current note will change to a new note whether that note is above or below the current note.
- [Assign 5-6] affect whether the envelopes will reset when the keys are played legato (i.e., if a second note is triggered while the first note is still held). When Legato is ON, they will not reset; when it is OFF, they will reset.
- [Assign 7] affects Glide response as well as the envelopes. When selected, the envelopes will not reset when the keys are played legato, and glide will also happen. When the keys are not played legato, glide will not happen. Results depend on the Glide time being set high enough for the glide to be audible.

#### 12.2.4.3. Layer Mode

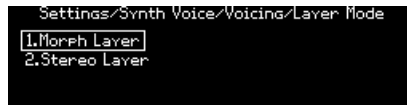

Let's you choose from [Morph Layer \[p.39\]](#) and [Stereo Layer \[p.39\]](#).

#### 12.2.4.4. Unison voice count

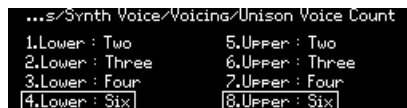

You can define the number of voices used by each zone in Unison mode. Use [Assign 1-4] to set the value for the lower zone and [Assign 5-8] to set the value for the upper zone.

### 12.2.4.5. Unison Detune

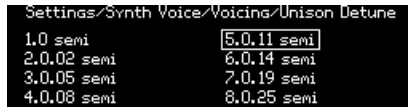

[Assign 1-8] lets you choose values ranging from 0 semitone to 0.25 semitones to detune voices.



Unison Detune applies to Lower and Upper Unison with the same values.

### 12.2.4.6. Analog Accuracy

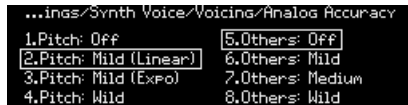

Classic analog synths are known for some instability and non-linearity in the way their components respond. A little can help create a fat sound; a lot can be annoying. The PolyBrute lets you decide just how much of it you'd like. This menu can also be accessed by holding the **Settings** button and wiggling the [Fine Tune] knob.

#### Pitch

Use [Assign 1-4] to set the pitch instability:

- Off
- Mild Linear
- Mild Expo
- Wild

#### Others

Other aspects PolyBrute can collectively vary include oscillator pulse width, filter cutoff and resonance, envelope times, envelope sustain levels, and LFO rates when they're not synced to tempo. Use [Assign 5-8] to select the options:

- Off
- Mild
- Medium
- Wild

## 12.3. Preset>Out section

The Settings / Out Section category has six main areas, as pictured below.

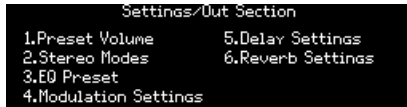

### 12.3.1. Out>Preset volume

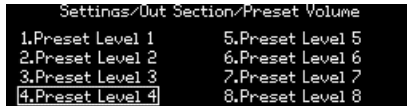

Use [Assign 1-8] to set the volume for the current patch. The range between levels 1 and 8 is about 15 dB, with 7 being the default setting. This can help control the levels between patches.

### 12.3.2. Out>Stereo modes

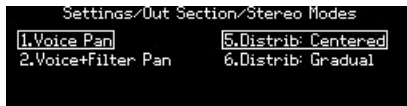

Use [Assign 1-2] to define the operation of the stereo control. For descriptions of each mode, see the [Stereo spread section](#) [p.35].

Use [Assign 5-6] to define the distribution of the voices in the stereo field and the values sent by the voices in the matrix. See [Voice source section](#) [p.53]

### 12.3.3. Out>Modulation Settings

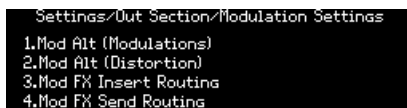

Use [Assign 1-2] to select the kind of effect to use on the Mod FX when Mod Alt is selected.

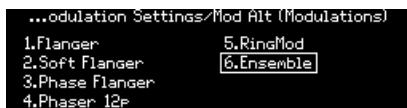

```
...Modulation Settings/Mod Alt (Distortion)
1.Subtle Tape          5.Germanium
2.Classic Disto       6.BitCrusher
3.Soft Clip           7.DownSampler
4.Worn Out Tape
```

Use [Assign 3-4] to choose the insert/send routing of your Mod FX.

```
...odulation Settings/Mod FX Insert Routing
1.Pre Delay
2.Post Delay
3.Post Reverb
```

```
.../Modulation Settings/Mod FX Send Routing
1.Pre Send
2.Send Wet
3.Post Return
```

### 12.3.4. Out>Delay settings

```
Settings/Out Section/Delay Settings
1.Delay Time Mode
2.Delay Filters
3.Delay Alt Preset
```

#### 12.3.4.1. Delay Time Mode

```
...t Section/Delay Settings/Delay Time Mode
1.Hertz
2.Sync Binary
3.Sync Triplet
4.Sync Dotted
```

Edit the “Delay Time Mode”. Use [Assign 1-4] to specify whether the delay is synced to the master clock or not, and which time division it uses when synced.

- **Hertz**: not synced
- **Binary, Triplet, or Dotted**: synced

When one of the synced options is selected, the delay time division is displayed as the Delay Time knob is turned.



### 12.3.4.2. Delay Filters

```
...Out Section/Delay Settings/Delay Filters
1.Delay HP: Bypass      5.Delay LP: Bypass
2.Delay HP: Low Cutoff 6.Delay LP: High Cutoff
3.Delay HP: Mid Cutoff 7.Delay LP: Mid Cutoff
4.Delay HP: High Cutoff 8.Delay LP: Low Cutoff
```

### 12.3.4.3. Delay Alt Preset

```
... Section/Delay Settings/Delay Alt Preset
1.Stereo Delay          5.Stereo Spread
2.Long Delay            6.Parallel
3.BBD PingPong         7.BBD Spread
4.Karplus
```

Use [Assign 1-7] to select the kind of effect to use on the Delay FX when the Alt Type is selected.

## 12.3.5. Out>Reverb Settings

```
Settings/Out Section/Reverb Settings
1.Reverb HP Filter
2.Reverb Alt Preset
```

### 12.3.5.1. Reverb HP filter

```
...Section/Reverb Settings/Reverb HP Filter
1.Bypass
2.Low Cutoff
3.Mid Cutoff
4.High Cutoff
```

Edit the Reverb HP Filter. Use [Assign 1-4] to select the HP filter cutoff: Bypass, Low, Mid, or High.

### 12.3.5.2. Reverb Alt Preset



- Edit the Reverb Alt Preset. These five variations are the ones that can be selected for (and saved with) the patch you're creating:
  - Bright Plate
  - Room
  - Dreamy
  - Springy
  - Delayed Plate

## 12.4. Preset>Expression control

The Settings / Expression Control category has eight options, as pictured below.

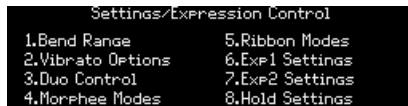

### 12.4.1. Expression Control>Bend range

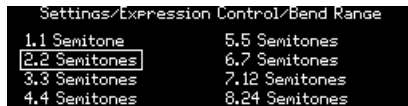

Use [Assign 1-8] to set the bend range for the Pitch wheel. Maximum range is +/- 24 semitones (+/-2 octaves).

### 12.4.2. Expression Control>Vibrato Options

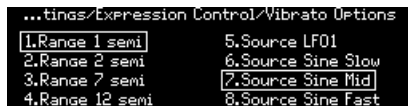

- Use [Assign 1-4] to select the range for the Vibrato: 1, 2, 7, or 12 semitones.
- Use [Assign 5-8] to select the Vibrato source: LFO 1, or a dedicated LFO with three preset speeds.

### 12.4.3. Expression Control > Duo Control

```
Settings/Expression Control/Duo Control
1.Duo AT
2.Duo Bend
```

This let you choose between duophonic aftertouch and duophonic pitch bend control.

```
...gs/Expression Control/Duo Control/Duo AT
1.AT Monophonic
2.AT Duophonic
3.AT Duo Upper Split
4.AT Duo Lower Split
```

The PolyBrute can optionally produce duophonic aftertouch, restricting aftertouch to certain notes. This lets you (for example) play a chord and then solo over it with aftertouch only happening on the solo note. The settings are:

- **AT Monophonic:** Aftertouch affects all voices.
- **AT Duophonic:** Aftertouch only affects the last played note, or group of notes that was played simultaneously.
- **AT Duo Upper Split:** Same as Duophonic, but only applies to the Upper part in a split or layer.
- **AT Duo Lower Split:** Same as Duophonic, but only applies to the Lower part in a split or layer.

```
.../Expression Control/Duo Control/Duo Bend
1.PB Monophonic
2.PB Duophonic
3.PB Duo Upper Split
4.PB Duo Lower Split
```

This allows for "duophonic" pitch bend control, where Pitch Bend control applies only to the last set of played/held notes. This allows, for example, for a lead with pitch bend that doesn't affect a sustained chord. Values are:

- **PB Monophonic (default):** Pitch bend functions in the traditional way.
- **PB Duophonic:** Pitch bend works as described above over the entire keyboard.
- **PB Duo Upper Split:** Duophonic pitch bend only on the Upper zone.
- **PB Duo Lower Split:** Duophonic pitch bend only on the Lower zone.

## 12.4.4. Expression Control > Morphée Modes



Use [Assign 1-4] to define the Morphée response.

- **Tap:** Absolute, Instant return to O.
- **Hold:** Absolute, Never return to O.
- **Scan:** Scaled, Fast return to O.
- **Hold Scan:** Scaled, Never return to O.

Where:

- **Absolute:** The modulation range of each axis is from 0 (X: full left; Y: full down) to 127 (X: full right; Y: full up). Exact values are determined by physical position of the finger on the X/Y axes.
- **Scaled:** Start at the current finger position on the X/Y axis and scale (average) the range to cover the remaining values in that direction. When the direction is reversed the normal modulation range is restored. Morphée is reset when a patch is selected, so the modulation range of the Z axis is absolute.
- **Instant return to 0:** When modulation input stops for one or more axes, values return to zero instantly.
- **Fast return to 0:** When modulation input stops for one or more axes, values return to zero quickly, but not instantly.
- **Never return to 0:** When modulation input stops, modulation values hold at current levels.

## 12.4.5. Expression Control > Ribbon Modes



Use [Assign 1-4] to define the Ribbon response.

- **Tap:** Absolute, Instant return to O.
- **Hold:** Absolute, Never return to O.
- **Scan:** Relative, Fast return to O.
- **Slow Scan:** Relative, Slow return to O.

where:

- **Absolute:** If touched on the left side, output a value below 64. If touched on the right side, output a value above 64. Exact values are determined by physical position of the finger.

- **Relative:** The physical position of the finger becomes the zero point for modulation. Motion to the left generates values that decrease from 64; motion to the right generates values that increase from 64 upward. Min/max values might not be reached, or might be reached early, depending on physical space remaining.
- **Instant return to O, Never return to O, Fast return to O:** See descriptions in the Expression: Morphée section above.
- **Slow return to O:** Same as Fast return to O, but slower.

#### 12.4.6. Expression Control>Exp1, Exp2 Settings

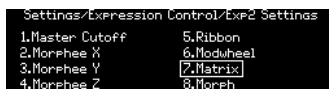
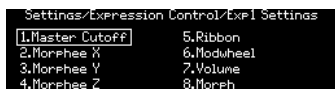

Use [Assign 1-8] to choose the setting for the selected Expression pedal. The options for both pedals are almost identical, with the exception of option 7: Exp1 controls master volume; Exp2 becomes a source in the Mod Matrix.

#### 12.4.7. Expression Control>Hold



When the Hold function of the Sequencer/Arpeggiator is active, this setting decides which part of a split continues to sound when you release the keys.

- **Hold Upper:** Only the Upper part is held.
- **Hold Lower:** Only the Lower part is held.

The **Timbrality** button must be set to Split for these settings to be meaningful.



Use Hold Lower to trigger an Arpeggiator pattern and then solo over it. If you want a drone or pad to continue over an Arpeggiator pattern that you play in real time, use Hold Upper.

## 12.5. Preset>Preset info

The Settings / Preset Info category has four options, as pictured below.



### 12.5.1. Preset info>Init

This option will [initialize the patch \[p.15\]](#). The result is the same as holding the Panel left arrow + pressing [Preset].

### 12.5.2. Preset info>Details

This option shows information about the current patch: type, sound designer, and revision number.

### 12.5.3. Preset info>Generate

This option [generates a random program \[p.47\]](#) and shows the name "Generated" in the display when you go back to Preset view:



### 12.5.4. Preset info>Sound designer



Use [Assign 2-7] to enter the name of the sound designer for the current patch. The process is described [here \[p.48\]](#).

## 12.6. Global>Sync

The Global / Sync category has four options, as pictured below.

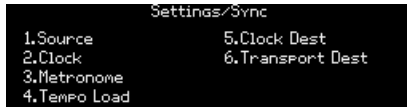

### 12.6.1. Sync>Source



Use [Assign 1-5] to make a selection. Auto detects an incoming clock and syncs to that. If no clock is present, the internal clock is selected automatically at the last known tempo.

### 12.6.2. Sync>Clock



Use [Assign 1-4] to select the clock rate that will be sent and received via the Sync jacks on the rear panel. There are four options:

- **One Step** advances the Sequencer/Arpeggiator by one step with each clock impulse that is received.
- **2PPQ** sends and receives two pulses per quarter-note.
- **24PPQ** sends and receives twenty-four pulses per quarter-note. This format is used by Roland DIN sync.
- **48PPQ** sends and receives forty-eight pulses per quarter-note.

### 12.6.3. Sync>Metronome



Use [Assign 1-4] to set the Metronome level. Use [Assign 5-6] to enable/disable the Count-in feature.

#### 12.6.4. Sync>Tempo Load



Use [Assign 1-3] to select how the tempo will be affected when loading a preset. There are 3 options:

- **Always** always loads the tempo that was stored in the preset.
- **If paused** only loads the tempo that was stored in the preset if the sequencer is currently paused.
- **Off** never loads the tempo that was stored in the preset and leaves the current tempo unaffected.

#### 12.6.5. Sync>Clock Send



Use [Assign 1-2] to turn MIDI Clock transmission on (default) or off.

#### 12.6.6. Sync>Transport Send

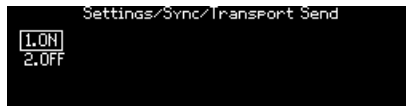

Use [Assign 1-2] to turn MIDI Transport Message transmission on (default) or off.



## 12.7. Global>Keyboard

The Global>Keyboard category has three options, as pictured below.



Use [Assign 1] to set the velocity and aftertouch curves. Use [Assign 2] to set the aftertouch sensitivity. Use [Assign 3] to set the aftertouch filter.

### 12.7.1. Curve Options



#### 12.7.1.1. Velocity Curve Options

After pressing [Assign 1] you will see three curve options for velocity (items 1-3 on the left side of the display). These affect the MIDI velocity transmitted to the PolyBrute based on how hard your fingers play the keys.

- **Velocity Lin** maintains an even relationship between finger velocity and MIDI velocity.
- **Velocity Log** increases rapidly as you increase your force at lower velocities – up to about the midpoint. After that it responds more gradually to increasing finger force.
- **Velocity Antilog** initially responds gradually to lower velocities, then increases MIDI velocity more steeply as you play harder.

In other words, the Log (logarithmic) curve roughly corresponds to a “lighter” keyboard action on an instrument such as a piano, and the Antilog corresponds to a “heavier” one.

#### 12.7.1.2. Aftertouch Curve Options

After pressing [Assign 1] you will see three curve options for aftertouch (items 5-7) on the right side of the display). These affect the MIDI velocity transmitted to the PolyBrute based on how hard your fingers press the keys after the initial strike. (Note: There is no item 4 on the display.)

- **Aft Lin** maintains an even relationship between pressure and MIDI velocity.
- **Aft Antilog 1** initially responds gradually to lower levels of pressure, then increases MIDI velocity more steeply as you press harder.
- **Aft Antilog 2** a more aggressive variant on Aft Antilog 1.

It is best to experiment with each to find the curve that you feel makes your aftertouch the most expressive.

## 12.7.2. Aftertouch Sensitivity

[Assign 2] in the Global > Keyboard menu brings up further options to fine-tune how the PolyBrute responds to aftertouch.

[Assign 1-4] buttons choose how much finger pressure it takes for the PolyBrute to register *any* aftertouch.

- 1. Start: Default
- 2. Start: High
- 3. Start: Low
- 4. Start: Very Low

[Assign 5-8] buttons choose how much finger pressure it takes for the PolyBrute to register maximum (127) aftertouch.

- 5. End: Default
- 6. End: Very High
- 7. End: High
- 8. End: Low

The choices here interact with the aftertouch curve options in interesting ways. So again, experiment and find the touch that hits the sweet spot for you.

## 12.7.3. Aftertouch Filter

The three options here determine how quickly the PolyBrute registers aftertouch in response to finger pressure. The differences are subtle, so try them all for yourself to find your own "sweet spot".

- 1. None
- 2. Fast
- 3. Slow

 If all these aftertouch options seem over the top, we added them because on so many synths that sense aftertouch, it goes from nothing to full blast when you press down on a key. Whatever parameter you have it assigned to ramps up all the way, all at once. PolyBrute aims to make aftertouch a truly expressive musical tool, letting you use its full range.

## 12.7.4. Pedals

```
Settings/Keyboard/Pedals
1.Polarity Expression 1
2.Polarity Expression 2
3.Polarity Sustain
```

Use [Assign 1-3] to select the expression pedal to configure

### 12.7.4.1. Polarity Expression 1 and 2 and Polarity Sustain

For Expression pedals 1 and 2, inverting the polarity by using [Assign 2] will cause the connected pedal to send lower values as you press it down further.

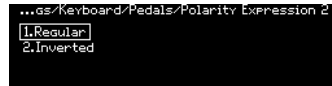
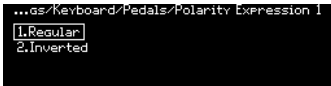

For the sustain pedal, use [Assign 1-3] to match the type of sustain pedal you have. [Assign 3] auto-detects the pedal polarity, which can be especially useful because who really remembers the polarity of each of the sustain/switch pedals they've accumulated?

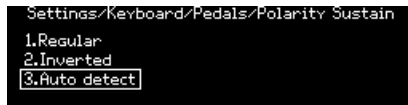

### 12.7.5. Knob catch



Use [Assign 1-3] to make a selection. These control responses are defined [here \[p.11\]](#).

## 12.8. Global>MIDI

The Global / MIDI category has seven options, as pictured below.

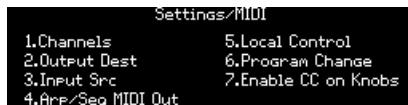

### 12.8.1. MIDI: Channels

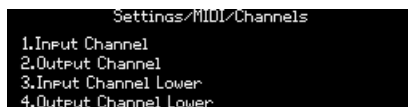

Use [Assign 1-4] to enter the desired menu.

### 12.8.1.1. Input Channel [upper/lower]

The pages for the upper and lower zones are identical, so both are described here.



Use [Assign 2] to return to the previous menu. Use [Assign 3-6] or turn the **Mod Amount** knob to select the desired MIDI channel. Use [Assign 7] to confirm the choice.

### 12.8.1.2. Output Channel [upper/lower]

The pages for the upper and lower zones are identical, so both are described here.



Use [Assign 2] to return to the previous menu. Use [Assign 3-6] or turn the **Mod Amount** knob to select the desired MIDI channel. Use [Assign 7] to confirm the choice.

## 12.8.2. MIDI>Output dest



Use [Assign 1-4] to select the destination for outgoing MIDI data.

## 12.8.3. MIDI>Input src



Use [Assign 1-4] to designate the source for incoming MIDI data.

## 12.8.4. MIDI>Arp/Seq MIDI out

Use [Assign 1-2] to make a selection. ON sends the output of the Seq/Arp section to the MIDI output; OFF does not send the data over MIDI.

### 12.8.5. MIDI>Local control

Use [Assign 1-2] to make a selection. ON enables the PolyBrute keyboard to trigger the internal voices. OFF disconnects the keyboard from the voice engine. Use this setting to prevent double-triggering of voices when using a DAW or a MIDI recording device that can echo the incoming MIDI data back to the PolyBrute.

### 12.8.6. MIDI>Program change

Use [Assign 1-4] to make a selection. Choices include: Off, Receive, Send, Both. This includes both MIDI Program Change and Bank Select messages.

### 12.8.7. MIDI>Enable CC on Knobs

Use [Assign 1-2] to make a selection. ON enables the PolyBrute to send and receive MIDI Continuous Controller (CC) messages when almost any knob is turned, via either USB MIDI or the 5-pin MIDI port. OFF disables this capability. See the [Specifications \[p.114\]](#) chapter for a chart of the CC numbers.

## 12.9. Global>Misc

The Global>Misc category has eight options, as pictured below.

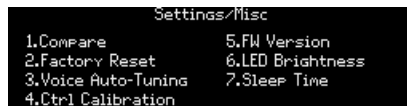

### 12.9.1. Misc>Compare

Use [Assign 1] to capture an edit to be compared. This same list will also appear in the list of [Snapshots \[p.46\]](#).

### 12.9.2. Misc>Factory reset

Use [Assign 1-4] to cancel this operation, or use [Assign 5-8] to restore all Global parameters to the factory settings. This will not affect patch data.

### 12.9.3. Misc>Voice auto-tuning

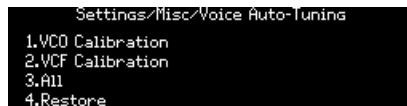

Use [Assign 1] to tune the oscillators, use [Assign 2] to tune the filters, or [Assign 3] to do both. Use [Assign 4] to restore the calibration values which were set in the factory.

## 12.9.4. Misc>Ctrl calibration

```
Settings/Misc/Ctrl Calibration
1.Wheels Calibration      5.Save Current Calib
2.Ribbon Calibration      6.Restore Factory
3.Morphee Calibration    7.Morphee Disable
4.Cancel Current Calib
```

Use [Assign 1-3] to enter the desired menu. Use [Assign 4] to cancel the current calibration routine, and use [Assign 5] to save the current controller calibrations. Use [Assign 6] to restore the controllers to their factory calibrations.

### 12.9.4.1. Wheels Calibration

```
...Misc/Ctrl Calibration/Wheels Calibration
1.Pitch Wheel Min        5.Mod Wheel Max
2.Pitch Wheel Center
3.Pitch Wheel Max
4.Mod Wheel Min
```

Move the desired wheel to the specified position and press an Assign button to set that as the calibration point for that wheel. To calibrate Pitch Wheel Center, return the Pitch wheel to its resting position and then press [Assign 2].

### 12.9.4.2. Ribbon Calibration

```
...Misc/Ctrl Calibration/Ribbon Calibration
1.Ribbon Min
2.Ribbon Center
3.Ribbon Max
4.Ribbon Sensitivity
```

- **Ribbon Min:** Touch the ribbon at its furthest position on the left and use [Assign 1] to set that as the point that will produce the minimum modulation output value.
- **Ribbon Center:** Touch the ribbon in the middle and use [Assign 2] to set that as the halfway point in its modulation range. This becomes the zero point between positive and negative modulation for the Absolute setting.
- **Ribbon Max:** Touch the ribbon at its furthest position on the right and use [Assign 3] to set that as the point that will produce the maximum modulation output value.
- **Ribbon Sensitivity:** to describe

### 12.9.4.3. Morphée Calibration

```
...isc/Ctrl Calibration/Morphee Calibration
1.Morphee Pressed
2.Morphee Released
3.Morphee Sensitivity
```

- Hold the Morphée all the way down and press [Assign 1] to define the maximum Z axis modulation point.
- Allow the Morphée to return to its resting position, remove your hand, and press [Assign 2] to define the minimum Z axis modulation point.
- Use [Assign 3] to set the sensitivity of the Morphée's spring-loaded Z axis. The options are:
  - **Default**
  - **Very High**
  - **High**
  - **Low**

### 12.9.4.4. Cancel/Save Current Calib

```
This operation will erase new calibrations
Are you sure?
Cancel      OK
```

```
This operation will save new calibrations
Are you sure?
Cancel      OK
```

Use [Assign 1-4] to cancel this operation, or use [Assign 5-8] to proceed with the operation.

### 12.9.4.5. Restore Factory

```
This operation will restore factory calibrations
Are you sure?
Cancel      OK
```

Use [Assign 1-4] cancel the operation, or use [Assign 5-8] to restore factory calibrations.

### 12.9.4.6. Morphée Disable

```
...as/Misc/Ctrl Calibration/Morphee Disable
1.Disable None
2.X Axis
3.Disable All
```

Use [Assign 1-3] to disable specific Morphée gestures according to the following options:

- **1. Disable None:** All Morphée gestures will produce results.
- **2. X Axis:** The horizontal (X) axis of the Morphée is disabled.
- **3. Disable All:** No Morphée gestures will produce results.

### **12.9.5. Misc>FW version**

Press [Assign 6] to view the current firmware version of your PolyBrute.

### **12.9.6. Misc>LED Brightness**

Use the [Assign 1-3] buttons to select the brightness of all LEDs on the PolyBrute front panel (except for the Matrix LEDs). The options are: Full (the default), Dim, Very Dim.

### **12.9.7. Misc>Sleep Time**

Use the [Assign 1-3] buttons to select the time it takes for the PolyBrute to go into a power-saving sleep mode. The options are:

- 1. 1 minute
- 2. 5 minutes
- 3. 15 minutes



## 13. SPECIFICATIONS

AC Input Specifications	
Voltage	100V - 240V AC
Power	85W
Frequency	50-60 Hz
Safeguard fuse characteristics	F3.15A, 250v AC

Pedal Connections	
Expression (x2)	Tip = Pot center tap; Ring = 3.3V; Sleeve = Ground
Sustain	Normally open

Sync (TRS)	
Gate	0 - 5V

Audio I/O	Jack	Level
Master Out L/R	Mono TS	+4dBu

- Operating temp: 15°-35° C (59°-95° F)
- Dimensions: 972x378x110mm
- Weight: 20kg
- Keyboard: 5-octave, velocity-sensitive, channel aftertouch, adjustable curves
- **Performance controls**
  - Morphée, a 3-D controller that can modulate parameters along the X, Y, and Z axes simultaneously
  - Aftertouch (pressure sensitivity)
  - Ribbon controller
  - Pitch and Modulation wheels
  - Octave buttons can shift keyboard range +/- 2 octaves from center
- **Other hardware features**
  - Stereo outputs
  - MIDI In/Out/Thru connectors
  - Clock In/Out for integration with modular systems
  - USB type B connector for use with DAWs and PolyBrute Connect
  - Headphone jack with independent level control

## 13.1. MIDI Continuous Controller assignments

VCO 1 Parameter	MIDI CC	VCO 2 Parameter	MIDI CC	EXPRESSION Parameters	MIDI CC
Tune	66	Tune	72	Exp 1	11
Metalizer	70	Sub Mix	14	Exp 2	4
Pulse Width	69	Pulse Width	75	Glide	5
Sync	65	FM 2 > 1	77	Morph Knob	3
Saw / Tri Mix	17	Saw / Tri Mix	15	Ribbon	9
Saw / Square Mix	12	Saw / Square Mix	16	Morphée X	114
				Morphée Y	115
				Morphée Z	89

FILTER FM Parameter	MIDI CC	MIDI Parameter	MIDI CC	NOISE Parameter	MIDI CC
VCO 2 > VCF 1	79	Mod Wheel	1	Noise Color	22
Noise > VCF 2	80				

LADDER FILTER Parameter	MIDI CC	STEINER FILTER Parameter	MIDI CC	MIXER Parameter	MIDI CC
Cutoff	25	Cutoff	23	VCO 1	18
Resonance	87	Resonance	83	VCO 2	19
Disto	85	Brute Factor	82	Noise	21
Series > Para	86	LP > HP > BP	81		
VCF Env Amt	26	VCF Env Amt	24		
Level	8	Level	7		

VCF ENV Parameter	MIDI CC	VCA ENV Parameter	MIDI CC	MOD ENV Parameter	MIDI CC
Velo	94	Velo	95	Delay	108
Attack	102	Attack	105	Attack	109
Decay	103	Decay	106	Decay	110
Sustain	28	Sustain	29	Sustain	30
Release	104	Release	107	Release	111

LFO 1 Parameter	MIDI CC	LFO 2 Parameter	MIDI CC	LFO 3 Parameter	MIDI CC
Phase	90	Fade In	92	Curve	67
Rate	91	Rate	93	Symmetry	68
				Rate	73

<b>EFFECTS Parameter</b>	<b>MIDI CC</b>	<b>SEQUENCER Parameter</b>	<b>MIDI CC</b>	<b>FILTERS COMMON Parameter</b>	<b>MIDI CC</b>
Mod Intensity	13	Rate	116	Master Cutoff	27
Delay Level	31	Gate	118	Key Track	71
Delay Time	112	Motion Rec Rate	117		
Delay Regeneration	113				
Reverb Level	2				
Reverb Time	78				
Reverb Damping	76				
Stereo	10				

## 14. DECLARATION OF CONFORMITY

### 14.1. FCC

#### **WARNING: DO NOT MODIFY THE UNIT!**

Any modifications or other changes to this unit not approved by the party responsible for compliance could void the user's authority to operate this equipment.

This device complies with Part 15 of the FCC Rules. Operation is subject to the following two conditions: (1) This device may not cause harmful interference, and (2) This device must accept any interference received, including interference that may cause undesired operation.

Responsible Party in USA: Zedra, 185 Alewife Brook Parkway, #210, Cambridge, MA 02138, United States T: +1 857 285 5953

Trade Name: ARTURIA, Model Number: PolyBrute

Note: This equipment has been tested and found to comply with the limits for a Class B digital device, pursuant to part 15 of the FCC Rules. These limits are designed to provide reasonable protection against harmful interference in a residential installation. This equipment generates, uses, and can radiate radio frequency energy and, if not installed and used in accordance with the instructions, may cause harmful interference to radio communications. However, there is no guarantee that interference will not occur in a particular installation. If this equipment does cause harmful interference to radio or television reception, which can be determined by turning the equipment off and on, the user is encouraged to try to correct the interference by one or more of the following measures: • Reorient or relocate the receiving antenna. • Increase the separation between the equipment and receiver. • Connect the equipment into an outlet on a circuit different from that to which the receiver is connected. • Consult the dealer or an experienced radio/TV technician for help.

### 14.2. CANADA

This class B digital apparatus meets complies with Canadian ICES-003.

Cet appareil numérique de la classe B est conforme à la norme NMB-003 du Canada

### 14.3. CE

This device has been tested and found to comply with the limits of the European Council Directive on the approximation of the laws of the member states relating to Electromagnetic Compatibility according to 2014/30/EU, and Low Voltage Directive 2014/35/EU.

### 14.4. ROHS

This device has been produced with lead free solder and fulfills the requirements of the ROHS directive 2011/65/EU.

## 14.5. WEEE



This symbol indicates that the electrical and electronic equipment should not be disposed of as general household waste at its end-of-life. Instead, the products should be handed over to the applicable collection points for the recycling of electrical and electronic equipment for proper treatment, recovery, and recycling in accordance with your national legislation and the Directive 2012/19/EU (WEEE - Directive on Waste Electrical and Electronic Equipment). For more information about collection points and recycling of these products, please contact your local municipal office, your household waste disposal service, or the shop where you purchased the product.

## 15. SOFTWARE LICENSE AGREEMENT

In consideration of payment of the Licensee fee, which is a portion of the price you paid, Arturia, as Licensor, grants to you (hereinafter termed "Licensee") a nonexclusive right to use this copy of the PolyBrute Connect (hereinafter termed "SOFTWARE").

All intellectual property rights in the software belong to Arturia SA (hereinafter: "Arturia"). Arturia permits you only to copy, download, install and use the software in accordance with the terms and conditions of this Agreement.

The product contains product activation for protection against unlawful copying. The OEM software can be used only following registration.

Internet access is required for the activation process. The terms and conditions for use of the software by you, the end-user, appear below. By installing the software on your computer you agree to these terms and conditions. Please read the following text carefully in its entirety. If you do not approve these terms and conditions, you must not install this software. In this event give the product back to where you have purchased it (including all written material, the complete undamaged packing as well as the enclosed hardware) immediately but at the latest within 30 days in return for a refund of the purchase price.

**1. Software Ownership** Arturia shall retain full and complete title to the SOFTWARE recorded on the enclosed disks and all subsequent copies of the SOFTWARE, regardless of the media or form on or in which the original disks or copies may exist. The License is not a sale of the original SOFTWARE.

**2. Grant of License** Arturia grants you a non-exclusive license for the use of the software according to the terms and conditions of this Agreement. You may not lease, loan or sublicense the software. The use of the software within a network is illegal where there is the possibility of a contemporaneous multiple use of the program.

You are entitled to prepare a backup copy of the software which will not be used for purposes other than storage purposes.

You shall have no further right or interest to use the software other than the limited rights as specified in this Agreement. Arturia reserves all rights not expressly granted.

**3. Activation of the Software** Arturia may use a compulsory activation of the software and a compulsory registration of the OEM software for license control to protect the software against unlawful copying. If you do not accept the terms and conditions of this Agreement, the software will not work.

In such a case the product including the software may only be returned within 30 days following acquisition of the product. Upon return a claim according to § 11 shall not apply.

**4. Support, Upgrades and Updates after Product Registration** You can only receive support, upgrades and updates following the personal product registration. Support is provided only for the current version and for the previous version during one year after publication of the new version. Arturia can modify and partly or completely adjust the nature of the support (hotline, forum on the website etc.), upgrades and updates at any time.

The product registration is possible during the activation process or at any time later through the Internet. In such a process you are asked to agree to the storage and use of your personal data (name, address, contact, email-address, and license data) for the purposes specified above. Arturia may also forward these data to engaged third parties, in particular distributors, for support purposes and for the verification of the upgrade or update right.

**5. No Unbundling** The software usually contains a variety of different files which in its configuration ensure the complete functionality of the software. The software may be used as one product only. It is not required that you use or install all components of the software. You must not arrange components of the software in a new way and develop a modified version of the software or a new product as a result. The configuration of the software may not be modified for the purpose of distribution, assignment or resale.

**6. Assignment of Rights** You may assign all your rights to use the software to another person subject to the conditions that (a) you assign to this other person (i) this Agreement and (ii) the software or hardware provided with the software, packed or preinstalled thereon, including all copies, upgrades, updates, backup copies and previous versions, which granted a right to an update or upgrade on this software, (b) you do not retain upgrades, updates, backup copies and previous versions of this software and (c) the recipient accepts the terms and conditions of this Agreement as well as other regulations pursuant to which you acquired a valid software license.

A return of the product due to a failure to accept the terms and conditions of this Agreement, e.g. the product activation, shall not be possible following the assignment of rights.

**7. Upgrades and Updates** You must have a valid license for the previous or more inferior version of the software in order to be allowed to use an upgrade or update for the software. Upon transferring this previous or more inferior version of the software to third parties the right to use the upgrade or update of the software shall expire.

The acquisition of an upgrade or update does not in itself confer any right to use the software.

The right of support for the previous or inferior version of the software expires upon the installation of an upgrade or update.

**8. Limited Warranty** Arturia warrants that the disks on which the software is furnished is free from defects in materials and workmanship under normal use for a period of thirty (30) days from the date of purchase. Your receipt shall be evidence of the date of purchase. Any implied warranties on the software are limited to thirty (30) days from the date of purchase. Some states do not allow limitations on duration of an implied warranty, so the above limitation may not apply to you. All programs and accompanying materials are provided "as is" without warranty of any kind. The complete risk as to the quality and performance of the programs is with you. Should the program prove defective, you assume the entire cost of all necessary servicing, repair or correction.

**9. Remedies** Arturia's entire liability and your exclusive remedy shall be at Arturia's option either (a) return of the purchase price or (b) replacement of the disk that does not meet the Limited Warranty and which is returned to Arturia with a copy of your receipt. This limited Warranty is void if failure of the software has resulted from accident, abuse, modification, or misapplication. Any replacement software will be warranted for the remainder of the original warranty period or thirty (30) days, whichever is longer.

**10. No other Warranties** The above warranties are in lieu of all other warranties, expressed or implied, including but not limited to, the implied warranties of merchantability and fitness for a particular purpose. No oral or written information or advice given by Arturia, its dealers, distributors, agents or employees shall create a warranty or in any way increase the scope of this limited warranty.

**11. No Liability for Consequential Damages** Neither Arturia nor anyone else involved in the creation, production, or delivery of this product shall be liable for any direct, indirect, consequential, or incidental damages arising out of the use of, or inability to use this product (including without limitation, damages for loss of business profits, business interruption, loss of business information and the like) even if Arturia was previously advised of the possibility of such damages. Some states do not allow limitations on the length of an implied warranty or the exclusion or limitation of incidental or consequential damages, so the above limitation or exclusions may not apply to you. This warranty gives you specific legal rights, and you may also have other rights which vary from state to state.